



Hall Technologies • 1234 Lakeshore Dr Suite #150 Coppell, TX 75019 • halltechav.com

# HT-TRK1

Apollo Technology Room Kit

## User Manual

Version: V1.0.0



## Important Safety Instructions



1. Do not expose this apparatus to rain, moisture, dripping or splashing and that no objects filled with liquids, such as vases, shall be placed on the apparatus.



2. Do not install or place this unit in a bookcase, built-in cabinet or in another confined space. Ensure the unit is well ventilated.



3. To prevent risk of electric shock or fire hazard due to overheating, do not obstruct the unit's ventilation openings with newspapers, tablecloths, curtains, and similar items.



4. Do not install near any heat sources such as radiators, heat registers, stoves, or other apparatus (including amplifiers) that produce heat.



5. Do not place sources of naked flames, such as lighted candles, on the unit.



6. Clean this apparatus only with dry cloth.



7. Unplug this apparatus during lightning storms or when unused for a long period of time.



8. Protect the power cord from being walked on or pinched particularly at plugs.



9. Only use attachments / accessories specified by the manufacturer.



10. Refer to all servicing to qualified service personnel.

## Warnings of FCC

---

This equipment has been tested and found to comply with the limits for a Class B digital device, pursuant to Part 15 of the FCC Rules. These limits are designed to provide reasonable protection against harmful interference in a residential installation.

This equipment generates uses and can radiate radio frequency energy and, if not installed and used in accordance with the instructions, may cause harmful interference to radio communications. However, there is no guarantee that interference will not occur in a particular installation.

If this equipment does cause harmful interference to radio or television reception, which can be determined by turning the equipment off and on, the user is encouraged to try to correct the interference by one or more of the following measures:

- Reorient or relocate the receiving antenna.
- Increase the separation between the equipment and receiver.
- Connect the equipment into an outlet on a circuit different from that to which the receiver is connected.
- Consult the dealer or an experienced radio/TV technician for help.

Changes or modifications not expressly approved by the party responsible for compliance could void the user's authority to operate the equipment.

# Table of Contents

<a href="#">Introduction</a> .....	5
<a href="#">Overview</a> .....	5
<a href="#">Package Contents</a> .....	6
<a href="#">Specifications</a> .....	7
<a href="#">Panel Layout</a> .....	10
<a href="#">Receiver</a> .....	10
Transmitter.....	13
Control Panel.....	14
Installation and Wiring.....	16
Installation.....	16
Wiring.....	17
Pinout Information.....	19
Auto Switch.....	21
OSD.....	22
Control Panel Operation.....	23
Volume Knob.....	23
Source Select Buttons.....	23
<a href="#">ON/OFF Buttons</a> .....	22
IR Learning.....	24
RS232 Control.....	25
Web UI Control.....	26
Get Access to the Web UI.....	26
Basic A/V Control.....	27
Settings Page Introduction.....	28
<a href="#">Warranty Terms and Conditions</a> .....	37

# Introduction

---

## Overview

The Technology Room Kit is a turn-key solution for classroom and meeting space AV connectivity and control. It designed to provide HDMI video switching, system control, video extension and analog audio amplification in a convenient 3-piece kit. Utilizing the Valens VS2010 processor, power, control, video up to 4K@60Hz and audio are transported over a single Category 6a cable between the wall plate transmitter and the receiver with a minimum transport distance of 30m/100ft.

The wall plate control panel connects to the wall plate transmitter with a second Category 6a cable. The wall plate control panel allows remote switching of the sources and volume control from a convenient location. You can switch among four HDMI Inputs and you can scale the HDMI inputs up to 4K@60Hz. All the power needed for the system is provided by the receiver.

Additionally, the receiver features a built-in Web UI for control and analog audio de-embedding to your choice of a built-in 20W stereo amplifier for driving low impedance speakers, a 70V amplifier for driving commercial 70V speakers or stereo analog audio outputs. The system also supports DSP mixing function, which allows you to output mixing audio of the any two or three among VIDEO audio inputs, TX AUDIO IN and RX AUDIO IN. System includes monitoring software which allows easy multi-room configuration, system monitoring and control along with easy firmware updating of all devices from a central networked computer. An integrated Ethernet switch allows easy configuration with the IP Network. Remote USB 2.0 connectivity adds to the features that make it a one box solution for any modern classroom or conference space.

## Package Contents

### For Receiver:

- 1 x Receiver
- 1 x DC 24V 5A Power Adapter
- 1 x AC Cables with US Pins
- 1 x IR Emitter
- 2 x Phoenix Male Connectors (3.5mm, 2 Pins)
- 4 x Phoenix Male Connectors (3.5mm, 3 Pins)
- 1 x Phoenix Male Connector (5.08mm, 2 Pins)
- 1 x Phoenix Male Connector (5.08mm, 4 Pins)
- 2 x Mounting Brackets
- 4 x Mounting Screws
- 4 x Rubber Feet

### For Wall Plate Transmitter:

- 1 x Transmitter
- 1 x 2-Gang US Plastic Decora Plates, White
- 4 x #6-32\*20mm Screws, Silver
- 4 x #6-32\*7mm Screws, White

### For Control Panel

- 1 x Control Panel
- 1 x 1-Gang US Plastic Decora Plates, White
- 2 x #6-32\*20mm Screws, Silver
- 2 x #6-32\*7mm Screws, White
- 1 x Sheet of pre-printed button labels

## Specifications

Technical	
<b>Input/Output Port</b>	<p><b>Transmitter:</b> 3 x HDMI IN; 1 x Source Selector Button; 1 x AUDIO IN; 1 x USB Type-B Host; 1 x Micro USB FW update port; 1 x HDBT OUT; 1 x RJ45; 1 x REBOOT button</p> <p><b>Receiver:</b> 1 x HDBT IN; 1 x HDMI IN, 1 x HDMI OUT; 2 x LAN; 1 x Micro USB FW update port; 1 x 4Ω/8Ω SPEAKER OUT; 1 x 70V SPEAKER OUT; 1 x Speaker Out Select Switch; 3 x USB Type-A Device; 1 x IR OUT; 1 x RS232 IN; 1 x RS232 OUT; 1 x select switch (LINE IN/MIC IN/MIC IN with phantom power); 1 x AUDIO IN; 1 x MUTE IN; 1 x AUDIO OUT; 1 x DC 24V; 1 x RESET button</p> <p><b>Control Panel:</b> 1 x Volume control knob; 1 x IR Sensor; 6 x Button; 1 x RJ45</p>
<b>Input Signal Type</b>	<p><b>Transmitter</b> HDMI with 4K@60Hz YUV 4:2:0, HDCP 2.2</p> <p><b>Receiver:</b> HDMI with 4K@60Hz YUV 4:4:4, HDCP 2.2</p>
<b>Input Resolution Supported</b>	<p><b>HDMI IN on Transmitter:</b> <b>VESA:</b> 800x600<sup>8</sup>, 1024x768<sup>8</sup>, 1280x768<sup>8</sup>, 1280x800<sup>8</sup>, 1280 x960<sup>8</sup>, 1280x1024<sup>8</sup>, 1360x768<sup>8</sup>, 1366x768<sup>8</sup>, 1440x900<sup>8</sup>, 1600x900<sup>8</sup>, 1600x1200<sup>8</sup>, 1680x1050<sup>8</sup>, 1920x1200<sup>8</sup></p> <p><b>SMPTE:</b> 1280x720P<sup>6,7,8</sup>, 1920x1080P<sup>6,7,8</sup>, 3840x2160<sup>2,3,5,8*</sup>, 4096x2160<sup>2,3,5,8*</sup></p> <p>1 = at 23.98 Hz, 2 = at 24 Hz, 3 = at 25 Hz, 4 = at 29.97 Hz, 5 = at 30 Hz, 6 = at 50 Hz, 7 = at 59.94 Hz, 8 = at 60 Hz, * = 4:2:0</p> <p><b>HDMI IN on Receiver:</b> <b>VESA:</b> 800x600<sup>8</sup>, 1024x768<sup>8</sup>, 1280x768<sup>8</sup>, 1280x800<sup>8</sup>, 1280x960<sup>8</sup>, 1280x1024<sup>8</sup>, 1360x768<sup>8</sup>, 1366x768<sup>8</sup>, 1440x900<sup>8</sup>, 1600x900<sup>8</sup>, 1600x1200<sup>8</sup>, 1680x1050<sup>8</sup>, 1920x1200<sup>8</sup></p>

	<p><b>SMPTE:</b> 1280x720P<sup>6,7,8</sup>, 1920x1080P<sup>6,7,8</sup> 3840x2160<sup>2,3,5,8</sup>, 4096x2160<sup>2,3,5,8</sup></p> <p>1 = at 23.98 Hz, 2 = at 24 Hz, 3 = at 25 Hz, 4 = at 29.97 Hz, 5 = at 30 Hz, 6 = at 50 Hz, 7 = at 59.94 Hz, 8 = at 60 Hz</p>
<b>Output Signal Type</b>	HDMI with 4K@60Hz YUV 4:4:4, HDCP 2.2
<b>Output Resolution Supported</b>	<p><b>VESA:</b> 800x600<sup>8</sup>, 1024x768<sup>8</sup>, 1280x768<sup>8</sup>, 1280x800<sup>8</sup>, 1280x960<sup>8</sup>, 1280x1024<sup>8</sup>, 1360x768<sup>8</sup>, 1366x768<sup>8</sup>, 1440x900<sup>8</sup>, 1600x900<sup>8</sup>, 1600x1200<sup>8</sup>, 1680x1050<sup>8</sup>, 1920x1200<sup>8</sup></p> <p><b>SMPTE:</b> 1280x720P<sup>6,8</sup>, 1920x1080P<sup>6,8</sup> 3840x2160<sup>2,3,5,6,8</sup>, 4096x2160<sup>2,3,5,8</sup></p> <p>1 = at 23.98 Hz, 2 = at 24 Hz, 3 = at 25 Hz, 4 = at 29.97 Hz, 5 = at 30 Hz, 6 = at 50 Hz, 7 = at 59.94 Hz, 8 = at 60 Hz</p> <p><b>Note:</b> Built-in Scaler cannot output resolutions with Deep Color, HDR and 4:2:2/4:2:0 color space.</p>
<b>Audio Format</b>	<ul style="list-style-type: none"> <li>• HDMI IN/OUT: Stereo</li> <li>• All AUDIO IN &amp; MIC/LINE IN: Stereo</li> <li>• AUDIO OUT &amp; 4Ω/8Ω SPEAKER OUT: Stereo</li> <li>• 70V SPEAKER OUT: Mono</li> </ul>
<b>Maximum Data Rate</b>	HDMI IN, HDBT OUT on transmitter & HDBT IN on receiver: 10.2Gbps HDMI IN & HDMI OUT on receiver: 18Gbps
<b>Control Method</b>	Control Panel; Button on transmitter. LAN control (Web UI/Telnet); RS232

<b>General</b>	
<b>Operating Temperature</b>	0°C to 45°C (32°F to 113°F)
<b>Storage Temperature</b>	-20°C to 70°C (-4°F to 158°F)
<b>Humidity</b>	10% to 90%, non-condensing
<b>ESD Protection</b>	<b>Human-body Model:</b> ±8kV (Air-gap discharge)/



	±4kV (Contact discharge)
<b>Power Supply</b>	DC 24V 5A
<b>Power Consumption (Max)</b>	81W
<b>Device Dimension (W x H x D)</b>	<b>Transmitter:</b> 89mm x 105.6mm x 43mm/3.5" x 4.16" x 1.69" <b>Receiver:</b> 215mm x 42mm x 160.2mm/8.46" x 1.65" x 6.31" <b>Control Panel:</b> 45mm x 105.6mm x 28.7mm/1.77" x 4.16" x 1.13"
<b>Product Weight</b>	<b>Transmitter:</b> 0.3kg/0.66lb <b>Receiver:</b> 1.43kg/3.15lb <b>Control Panel:</b> 0.16kg/0.35lb

## Transmission Distance

**Note:** Straight-through category cable wired to T568B standard is recommended.

Cable Type	Range	Supported Video
<b>Cat 5e</b>	100m/330ft	Up to 1080P@60Hz 36bpp
	90m/295ft	1080P@60Hz 48bpp
<b>Cat 6/6a/7</b>	100m/330ft	1080P@60Hz 3D
		4K@30Hz 4:4:4 24bpp 4K@60Hz 4:2:0 24bpp
<b>HDMI</b>	<b>Input:</b> 15m/50ft <b>Output:</b> 10m/33ft	1080P@60Hz 24bpp
	<b>Input/Output:</b> 10m/33ft	4K@30Hz 4:4:4 24bpp 4K@60Hz 4:2:0 24bpp
	<b>Input:</b> 5m/16ft <b>Output:</b> 3m/10ft	4K@60Hz 4:4:4 24bpp

## Panel Layout

### Receiver

#### Front Panel

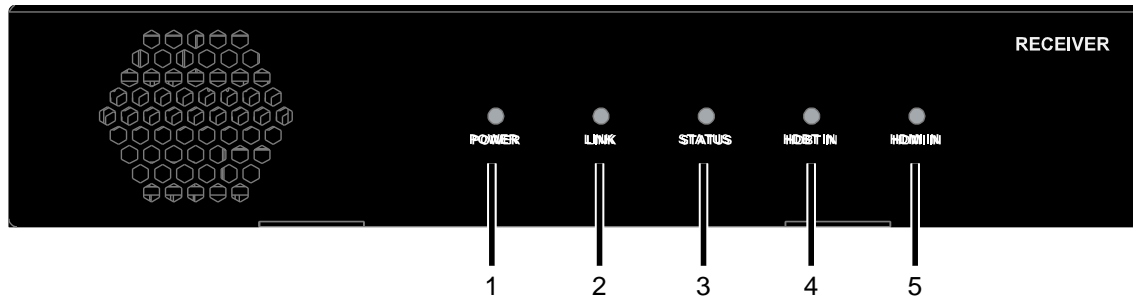

No.	Name	Description
1	POWER LED	<b>ON:</b> The receiver is powered on. <b>OFF:</b> The receiver is powered off.
2	LINK LED	<b>On:</b> The receiver is connected to the transmitter. <b>Off:</b> The receiver is not connected to the transmitter.
3	STATUS LED	<b>On:</b> The receiver is working properly. <b>Off:</b> The receiver is not working properly.
4	HDBT IN LED	<b>On:</b> The HDBT input is selected. <b>Off:</b> The HDBT input is not selected.
5	HDMI IN LED	<b>ON:</b> The HDMI IN on receiver is selected. <b>OFF:</b> The HDMI IN on receiver is not selected.

## Rear Panel

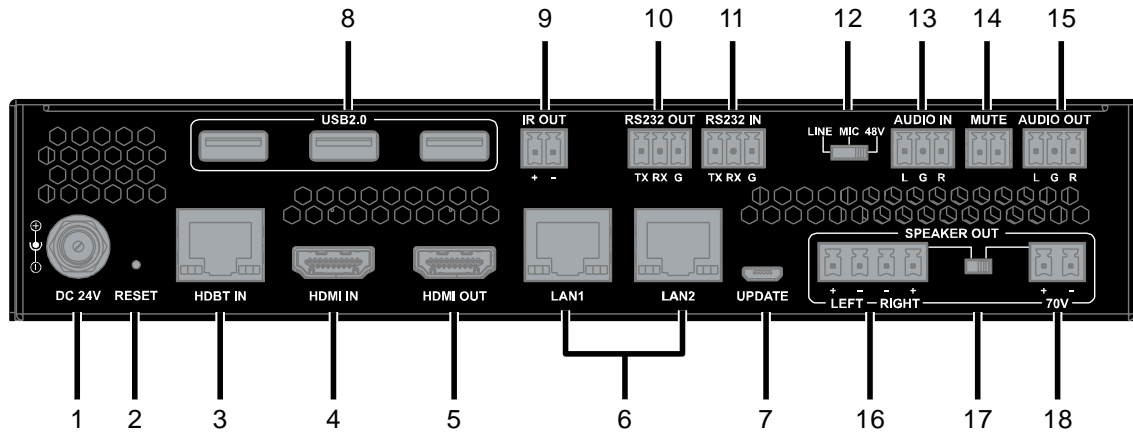

NO.	Name	Description
1	DC 24V	Connect to the DC 24V power adapter provided.
2	RESET Button	When the receiver is powered on, use a pointed stylus to hold down this button for three or more seconds, LED indicators will blink quickly, and the transmitter and receiver will be restored to its factory defaults.
3	HDBT IN	Connect to the transmitter via a Cat 5e/6/6a/7 cable.
4	HDMI IN	Connect to an HDMI source.
5	HDMI OUT	Connect to an HDMI display.
6	LAN (1-2)	Connect to a control system for Web UI and Telnet control.
7	UPDATE	Firmware update port.
8	USB 2.0	Connect to USB device(s) e.g. keyboard, mouse, USB camera, etc.
9	IR OUT	Connect to an IR device for IR output to display.
10	RS232 OUT	Connect to a RS232-enabled device for RS232 signal pass-through.
11	RS232 IN	Connect to a control PC or control system to control the Technology Room Kit through RS232 serial control.
12	LINE/MIC/48V	LINE/MIC/48V Selector switch for audio input. LINE: Line in MIC: MIC in 48V: MIC in with phantom power <b>*Warning*</b> : Before the selector switch is set to position “48V”, ensure any Line in device connected to “AUDIO IN” port has been removed; otherwise, device damage may occur.
13	AUDIO IN	Connect to an audio device based on the setting of the Line/MIC/48V selector switch.
14	MUTE	Connect to contact closure for muting the audio signal of AUDIO OUT and SPEAKER OUT. Note, the kit supports both paging and all mute modes which can be configured in web UI. In paging mode, only HDMI audio will be muted. HDBT

		transmitter AUDIO IN and HDBT receiver AUDIO IN still can be heard via AUDIO OUT and speaker outputs. In all mute mode, HDMI audio, HDBT transmitter AUDIO IN, and HDBT receiver AUDIO IN all will be muted, and AUDIO OUT and speaker outputs will have no audio.
15	AUDIO OUT	Connect to an audio receiver (e.g. amplifier).
16	LEFT- RIGHT	Connect to the 4Ω/8Ω speaker.
17	Selector Switch	Selector switch for speaker output.
18	70V	Connect to the 70V speaker.

## Transmitter

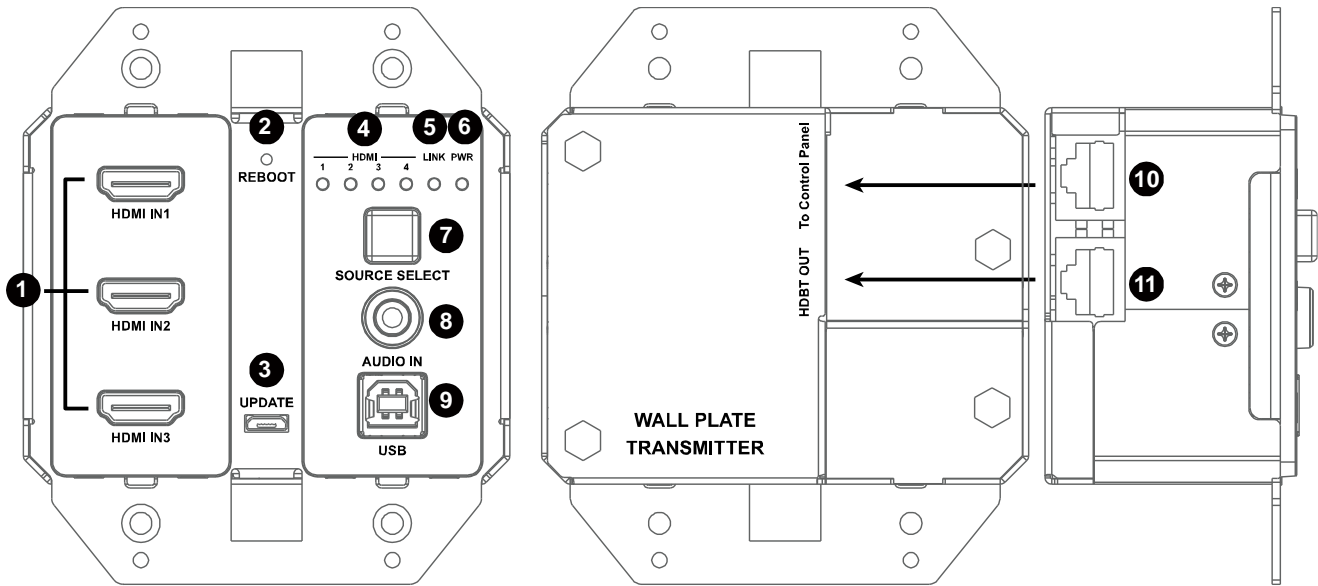

NO.	Name	Description
1	HDMI IN 1-3	Connect to the HDMI source device.
2	REBOOT	Use a pointed stylus to press the button to reboot the transmitter.
3	UPDATE	For firmware update.
4	HDMI IN LED (1-4)	LED 1-3: HDMI IN 1-3 on transmitter, LED 4: HDMI IN on Receiver. <b>ON:</b> The input source is selected. <b>OFF:</b> The input source is not selected.
5	LINK LED	<b>On:</b> The transmitter is connected to the receiver. <b>Off:</b> The transmitter is not connected to the receiver.
6	PWR LED	<b>ON:</b> The device is powered on. <b>OFF:</b> The device is powered off.
7	SOURCE SELECT	Source selector button. Short press the button to select the video source.
8	AUDIO IN	Audio input for stereo pass-through.
9	USB Host	Connect to a USB Host.
10	To Control Panel	Connect to the control panel via a Cat 5e/6/6a/7 cable.
11	HDBT OUT	Connect to the receiver via a Cat 5e/6/6a/7 cable.

## Control Panel

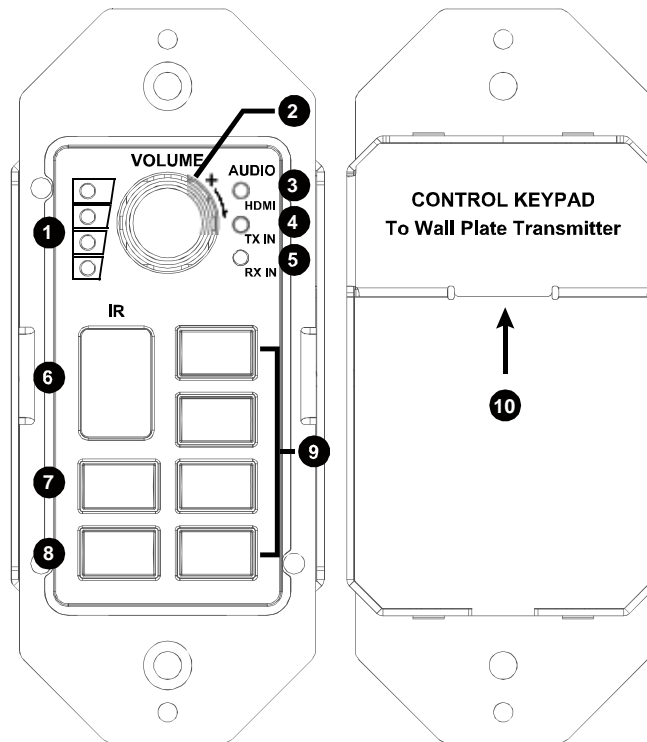

No	Name	Description
1	Volume LED	Volume level LED indicator. Raise the volume, the LEDs will be on in gradient from bottom to top; lower the volume, the LEDs will be off in gradient from top to bottom.
2	Volume Knob	<ul style="list-style-type: none"> <li>Turn the volume knob clockwise to raise the volume, counterclockwise to lower the volume.</li> <li>When the audio mixing function is set to off, short press the volume knob to switch among the audio sources – VIDEO, TX IN and RX IN.</li> <li>When the mixing audio function is set to on, short press the volume knob to select one audio input of the mixing audio or the mixing audio to adjust its volume.</li> </ul>
3	Video LED	<p><b>On:</b> The audio from selected video source is selected.</p> <p><b>Off:</b> The audio from selected video source is not selected.</p>
4	TX IN LED	<p><b>On:</b> The AUDIO IN on transmitter is selected.</p> <p><b>Off:</b> The AUDIO IN on transmitter is not selected.</p>
5	RX IN LED	<p><b>On:</b> The AUDIO IN on receiver is selected.</p> <p><b>Off:</b> The AUDIO IN on receiver is not selected.</p>
6	IR	Receives IR signals from IR remote.
7	On	<ul style="list-style-type: none"> <li>Short press the button to power on the display.</li> <li>Hold press the button for 3 seconds to power on the system.</li> </ul>

		<b>Note:</b> When power sync function is set to ON, short press the button, the display and system power on functions will be tied together.
8	Off	<ul style="list-style-type: none"> <li>• Short press the button to power off the display.</li> <li>• Hold press the button for 3 seconds to power off the system.</li> </ul> <b>Note:</b> When power sync function is set to ON, short press the button, the display and system power off functions will be tied together.
9	Video 1-4	<p>Source selector button.</p> <p>When a video source is selected, its corresponding selector button will light up.</p> <p>Video 1-3: HDMI IN 1-3 on transmitter.</p> <p>Video 4: HDMI IN on receiver.</p>
10	To Wall Plate Transmitter	Connect to the transmitter via a Cat 5e/6/6a/7 cable.

# Installation and Wiring

---

## Installation

**Note:** Before installation, please ensure the kit is disconnected from the power source.

### Steps to install the receiver on a suitable location:

1. Attach the installation bracket to the enclosure using the screws provided in the package separately.
2. The bracket is attached to the enclosure as shown.
3. Repeat steps from 1 to 2 for the other side of the unit.
4. Attach the brackets to the surface you want to hold the unit against using the screws (provided by others).

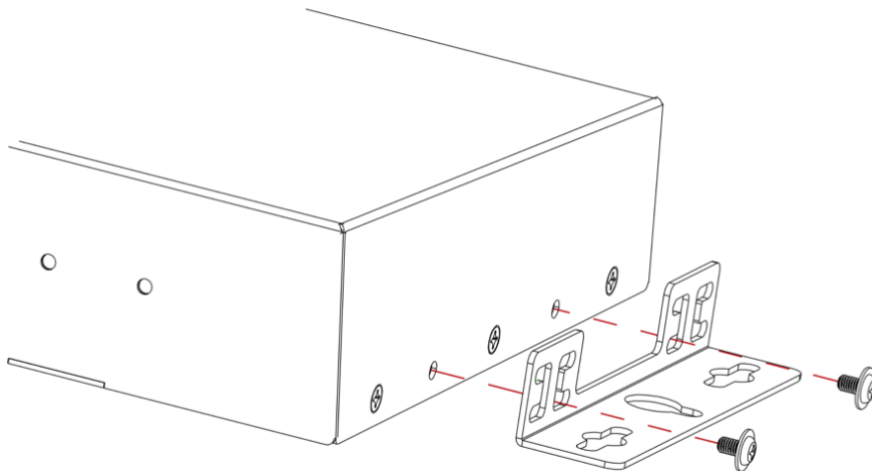



## Wiring

### Steps for device wiring:

1. Connect video source  
Connect the HDMI sources (such as PC, Blu-ray player, Apple TV, 4K media player, etc) to the HDMI IN ports of the transmitter respectively.
2. Connect HDBT OUT  
Connect HDBT OUT of the transmitter to HDBT IN of the receiver with a Cat 5e/6/6a/7 cable.
3. Connect HDMI IN/OUT  
Connect an HDMI source and an HDMI display to the HDMI IN and HDMI OUT ports of the receiver.
4. Connect AUDIO IN  
Connect an audio device or a microphone to the AUDIO IN of the receiver based on the setting of the Line/MIC/48V selector switch.
5. Connect SPEAKER OUT&AUDIO OUT  
Connect the speakers to the SPEAKER OUT of the receiver. If an external audio amplifier is to be used to with the system, connect it to the analog AUDIO OUT of the receiver.
6. Connect the control panel to the transmitter via a Cat 5e/6/6a/7 cable. This cable cannot exceed 30m/100ft.
7. Connect for additional control options:
  - LAN Control (Telnet/Web UI): Connect the receiver to the same network as the control PC or control system via its LAN port.
  - USB Control: Connect a USB host device to USB port of the transmitter and USB device to USB2.0 port of the receiver for remote KVM control.
  - IR pass-through: Connect an IR emitter to the IR OUT of the receiver.
  - RS232 Control: Connect the control PC to RS232 IN of the receiver to control the Technology Room Kit.
  - RS232 Pass-through: Connect a RS232-enabled display such as a projector to the RS232 OUT of the receiver.
8. Connect the power adapter provided to the receiver.  
One-way PoH enables the power to be sent from receiver to transmitter and control panel along Cat 5e/6/6a/7 cable. Only one power adapter is needed for the kit.
9. Power on all attached devices.

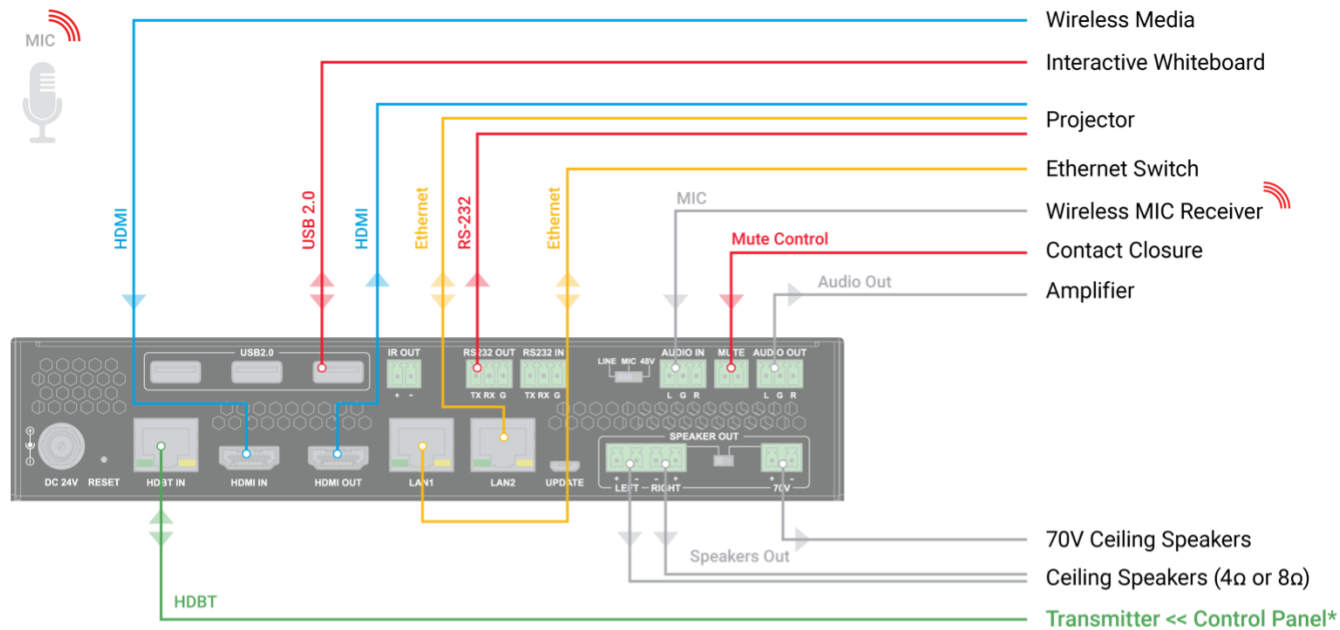

HDBT Transmitter << Control Panel (continued)

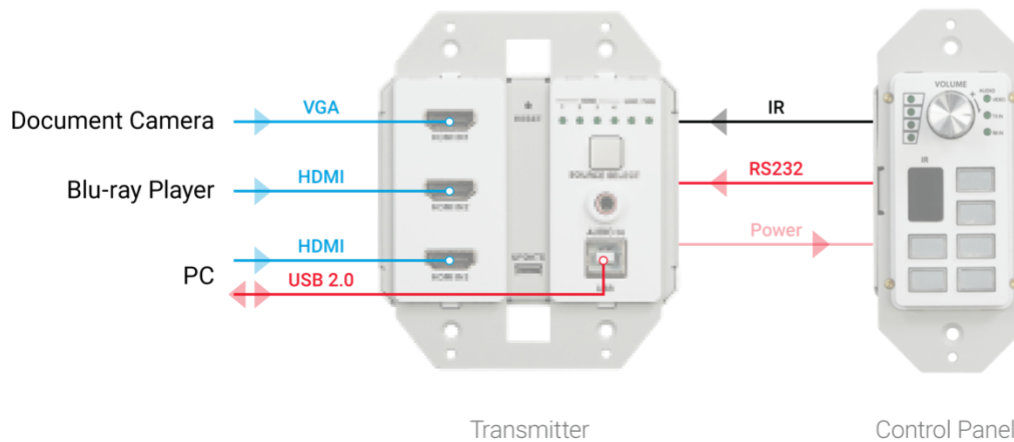

## Pinout Information

## IR OUT

“+” Connects to positive

“-” Connects to negative

### IR Emitter Wiring

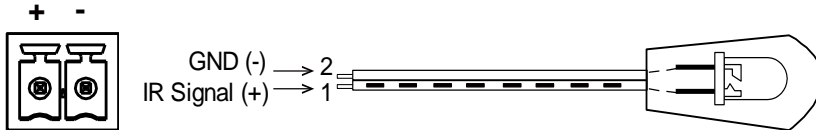

### Audio In

The pinout definition of Audio In connector may vary based on the Selector Switch’s setting as shown in the following:

Setting	Selector Switch Setting (Position)	Pinout Definition of Audio In Connector
1		Pin 1: L Pin 2: G Pin 3: R 
2		Pin 1: L+ Pin 2: G Pin 3: L- 
3		Pin 1: L+ Pin 2: G Pin 3: L- 

### Note that,

1. When in the LINE and 48V settings, the AUDIO IN accepts 1Vrms audio level at max. If AUDIO IN input signal exceeds the 1Vrms level, there may have audio clipping and distortion.
2. When in the MIC setting, the AUDIO IN accepts 150mVrms audio level at max. If AUDIO IN input signal exceeds the 150mVrms level, there may have audio clipping and distortion.
3. To connect wireless microphones, check if your microphone receiver outputs LINE or MIC level audio signal. Then switch the AUDIO IN setting accordingly.

### Audio Out

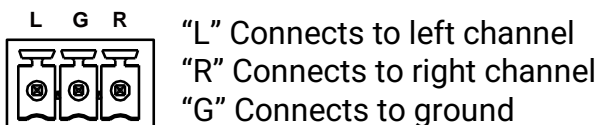

## RS232

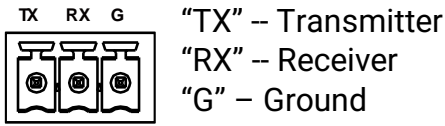

## Speaker Out

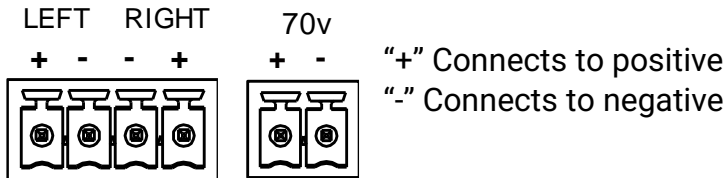

## Speaker Wiring Configurations

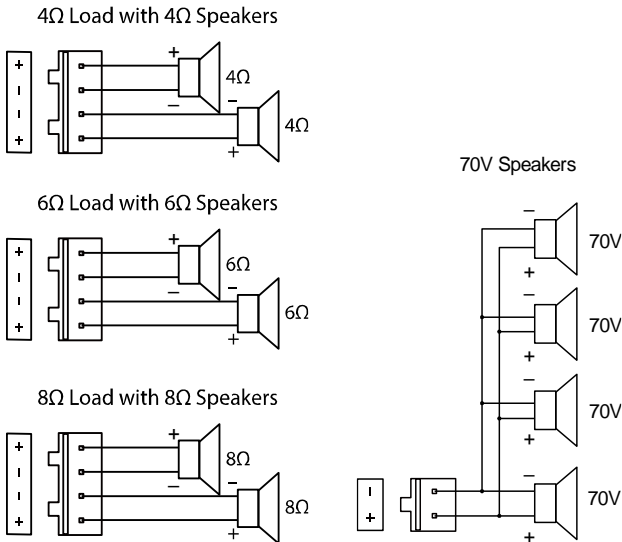

## Auto Switch

This kit supports auto switching among the four HDMI inputs on transmitter and receiver.

1. When multiple sources are inserted, power on all devices, the input will be switched to the active source with highest priority, the priority is RX HDMI IN > TX HDMI IN 1 > TX HDMI IN 2 > TX HDMI IN 3.
2. When a new source is inserted, the input will be switched to it automatically. (Last-In-First-

Out.)

3. When the currently selected source is removed, the input will be switched to the last selected port firstly; if the port has no source inserted, the input will be switched to the active source with highest priority.

**Note:**

- The Auto Switching function is enabled by default once all devices are powered on. To switch to a video source manually, see "[Control Panel Operation](#)" section for more information.
- Auto-Switching and Manually Switching can be set through Web UI and API commands (See "[Web UI Control](#)" section or separate document "API Command Set\_HT-TRK1").

## OSD

---

The kit supports OSD (On Screen Display) to display its IP address. Connect your HDMI display to the HDMI OUT of the receiver via an HDMI cable, once receiver/the kit is powered on/reboots/resets and becomes fully operational, HDMI display connected to the HDMI OUT of receiver will show the IP address of the receiver/the kit. When receiver/the kit is working, the action of reconnecting HDMI display to HDMI OUT of receiver will also trigger the IP address display.

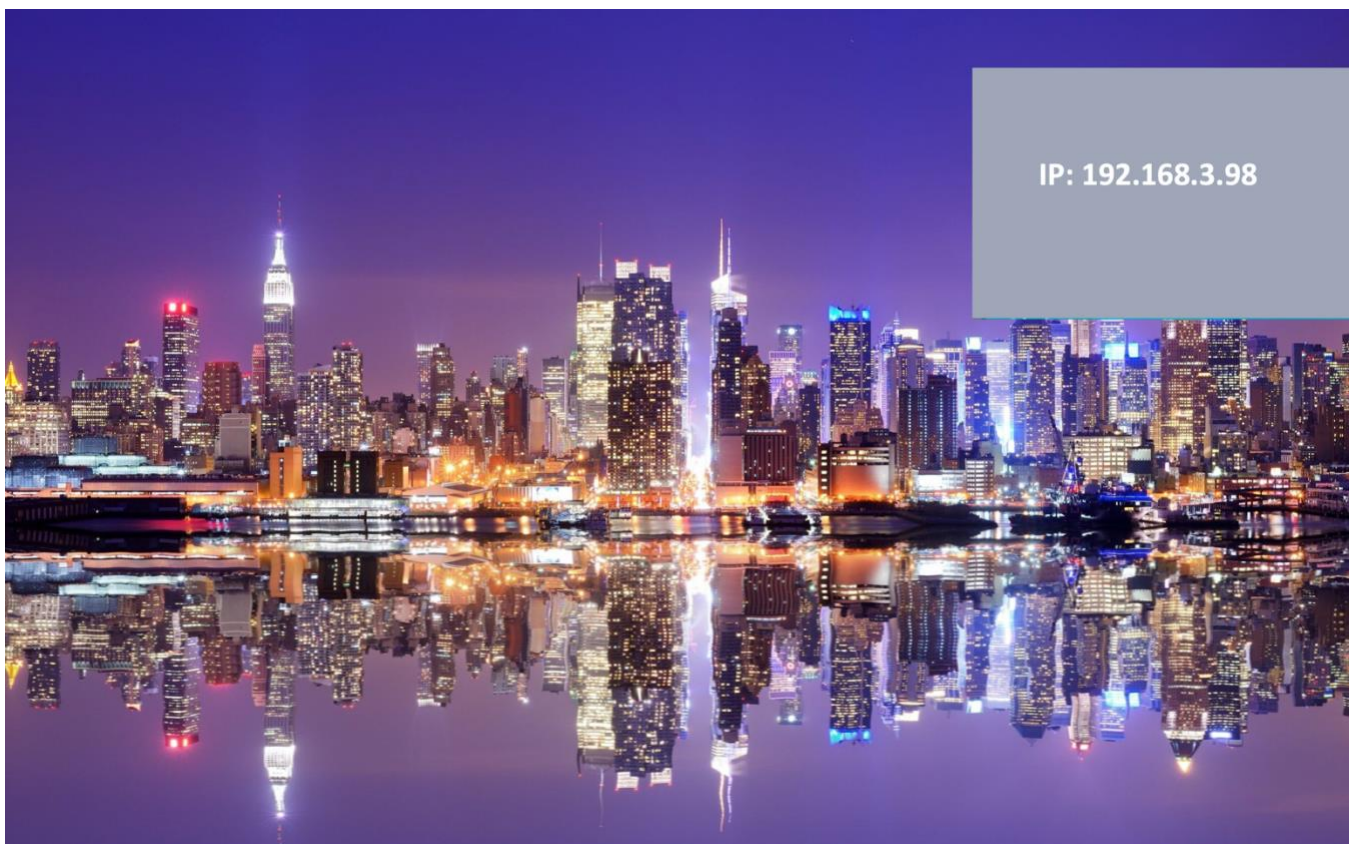

## Control Panel Operation

---

## Volume Knob

### 1. Rotate the Volume Knob

- Turn the Volume knob clockwise will raise the volume of the current audio;
- Turn the Volume knob counterclockwise will lower the volume of the current audio.

### 2. Short Press the Volume Knob

- When Audio mixing function is set to off, short press the volume knob will switch among the audio sources – VIDEO, TX IN and RX IN;
- When Audio mixing is set to on, short press the volume knob to select one audio input of the mixing audio or select the mixing audio to adjust the volume. The sequence is selected circularly among VIDEO, TX IN, RX IN and Mixing audio.

#### Note:

- Audio mixing function is set to on/off through web UI (please refer to “[Web UI Control](#)” section).
- VIDEO – Audio de-embedded from the selected video source; TX IN – AUDIO IN on transmitter; RX IN – AUDIO IN on receiver; Audio Mixing – Mixed Audio of any two or three audio inputs among VIDEO, TX IN and RX IN.

## Source Select Buttons

Press the **VIDEO (1-4)** buttons on control panel to select the specific video source. You can also press the **SOURCE SELECT** button on transmitter to switch among active video sources on both transmitter and receiver.

## ON/OFF Buttons

### Power On and Off the Display

To power on the display, short press the ON button on the control panel. The display can be controlled through CEC, RS232 and IR. By default, it is controlled through IR.

To power off the display, short press the OFF button on the control panel. The display can be controlled through CEC, RS232 and IR. By default, it is controlled through IR.

### Power On and Off the System

To power on the system, hold press the ON button on the control panel for 3 seconds. If the power sync function is set to on, short press the ON button, the display and system power on functions will be tied together.

To power off the system, hold press the OFF button on the control panel for 3 seconds. If the power sync function is set to on, short press the OFF button, the display and system power off functions will be tied together.

**Note:** Power sync function is set through web UI (Please refer to “[Web UI Control](#)” section).

## IR Learning

### Set Display Control Mode

Set display control by IR through API commands or Web UI. For more information, see the separate document “API Command Set\_ HT-TRK1” or “[Web UI Control](#)” section.

### **Enter IR Learning Mode**

Hold Press the **Video 1** button on the Control Panel for three seconds. The ON and OFF buttons will light up.

### **Start IR Learning**

Take display volume-up and volume-down function for example:

1. Press the **ON** button and it will start to flash.
2. Point the display remote at the control panel IR sensor and press the Volume Up button on the remote. The ON button on the control panel will stop flashing.
3. Press the **OFF** button and it will start to flash.
4. Point the display remote at the control panel IR sensor and press the Volume Down button on the remote. The OFF button on the control panel will stop flashing.

### **Exit IR Learning Mode**

Hold press the **Video 4** button on the control panel for three seconds. The ON and OFF buttons will go dark. You have now exited IR learning mode and your control panel is now configured to turn the display volume up and down using IR.

### **Test IR Control on Control Panel**

To test the volume up and down control through IR for your display, short press the ON and OFF buttons on the control panel. Your display should respond to the commands appropriately. If not, ensure the display control mode is set as IR.

**Note:** To turn the Technology Room Kit system on or off, you will need to hold press the ON and OFF buttons on the control panel for three seconds.

## **RS232 Control**

---

Advanced users may need to control the Technology Room Kit through RS232 serial communication. Connect a control PC or control system to the RS232 IN port of the receiver. API command for RS232 control is available in the separate document “API Command Set\_ HT-TRK1”. A professional RS232 serial interface software (e.g. Serial Assist) may be needed as well.

Before executing the API command through RS232 serial connection, please ensure RS232 interface of the device and the control PC are configured correctly.



<b>Parameters</b>	<b>Value</b>
Baud Rate	9600 bps
Data Bits	8 bits
Parity	None
Stop Bits	1 bit
Flow Control	None

# Web UI Control

The Web UI is accessible through a browser, e.g. Chrome, Firefox, Safari, Opera, IE10+, etc. By default, the kit is assigned an IP address from a DHCP server; if it fails, it will revert to a default IP of 169.254.x.x. To get its IP address quickly, see “OSD” section.

## Get Access to the Web UI

1. Connect the LAN port of the receiver to your PC using a straight UTP cable.
2. Input the IP address in your browser and press Enter. The following window will display.
  - To control the system without having to interact with the control panel, log into the kit as a user. The username is “**user**” and the default password is “**user**”. Click Login to enter User Control page.

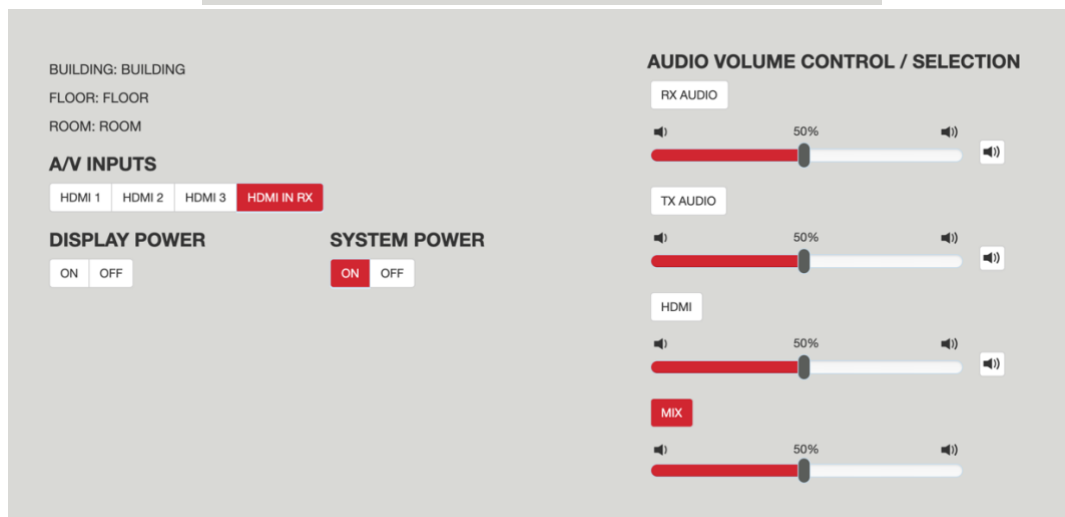
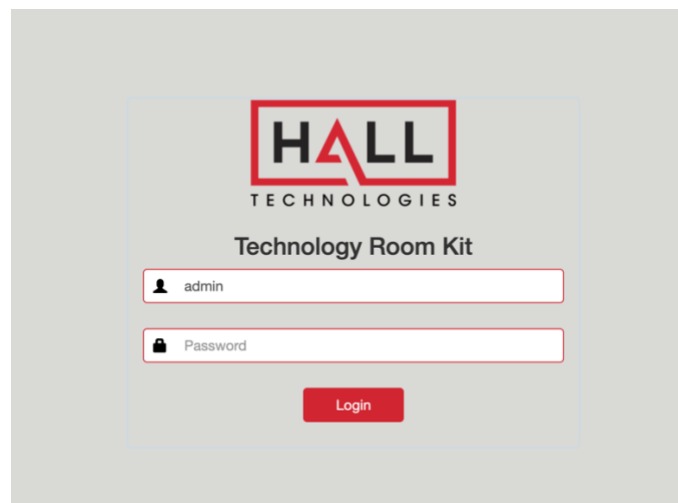

- For setting changes and firmware upgrade, log into the kit as an administrator. The username is “**admin**” and the default password is “**admin**”. Click Login to enter the Admin Control page.

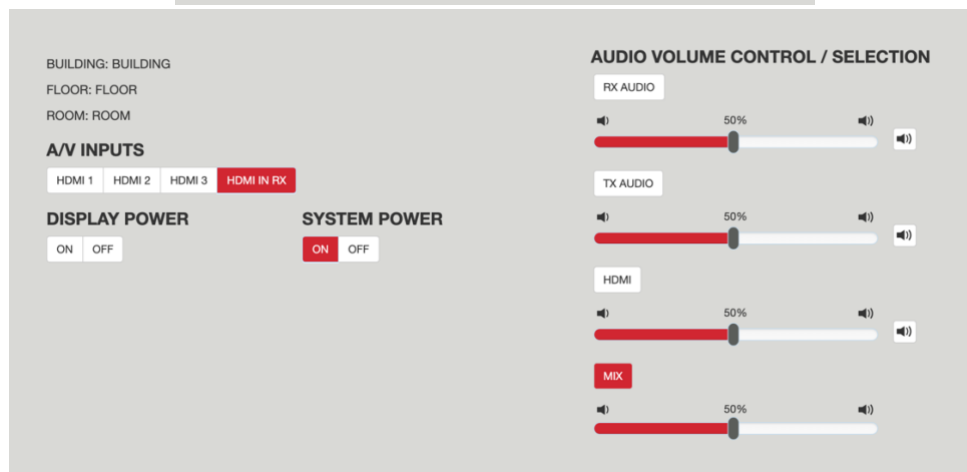
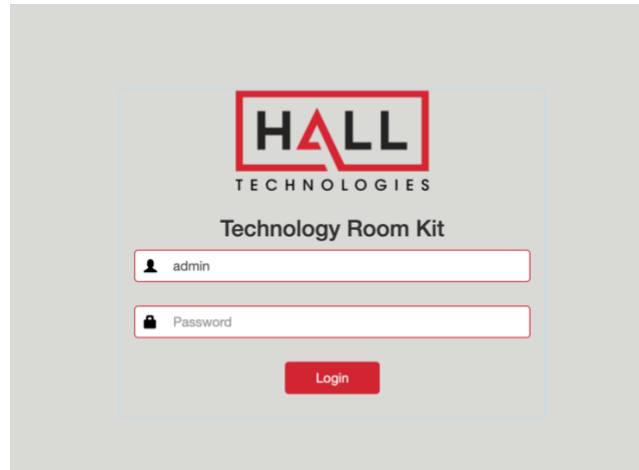

## Basic AV Control

### A/V INPUTS

Switch among the four inputs.

HDMI 1-3: HDMI IN 1-3 on transmitter;

HDMI 4: HDMI IN on receiver.

### DISPLAY POWER

**ON/OFF:** Click to turn the display on/off.

### SYSTEM POWER

**ON/OFF:** Click to turn the system on/off.

### AUDIO VOLUME CONTROL / SELECTION

- **Mute (🔇):** Click the 🔇 icon on the right of the sliders to mute/unmute corresponding audio sources separately.
- **RX AUDIO/TX AUDIO/HDMI SELECTION:** when MIXING audio function is set to OFF, click the RX AUDIO/TX AUDIO/HDMI button above the slider to switch to the corresponding audio

source.

- **VOLUME CONTROL**

- 1) When the MIXING audio function is set to OFF, use the sliders of RX AUDIO/TX AUDIO/HDMI to adjust the volume of RX AUDIO/TX AUDIO /HDMI separately.
- 2) When the MIXING audio function is set to ON, use the sliders of RX AUDIO/TX AUDIO/HDMI to adjust the volume of RX AUDIO/TX AUDIO/HDMI separately, and use the slider of MIX to adjust the audio volume after mixing.

**Note:** Please refer to “AUDIO MIX Tab” section to get how to set MIXING audio function to ON/OFF.

## Settings Page Introduction

To enter the Settings page, login as an administrator and click  on the upper-right corner of the control page.

 : Click to return to Admin Control page.

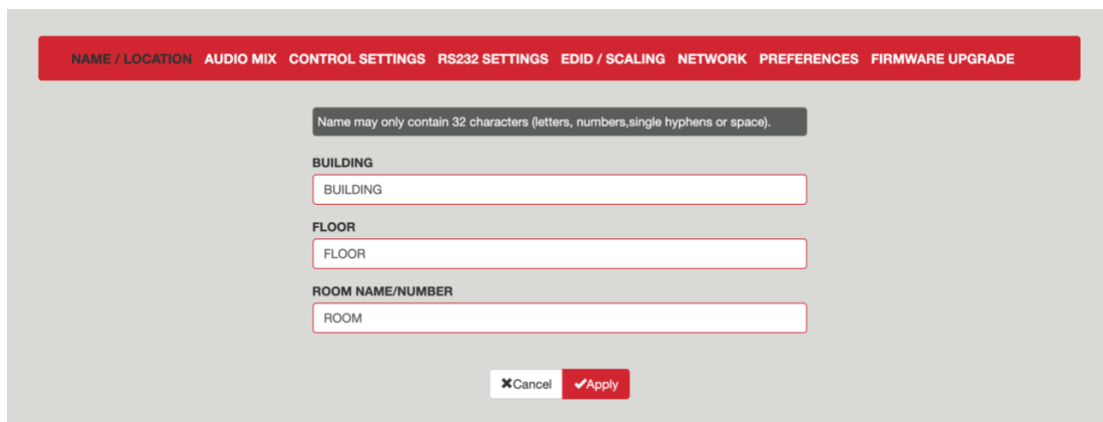

### NAME/LOCATION Tab

This tab allows you to define the location information, including building, floor, and room name/number.

- **Apply/Cancel:** Save or cancel the setting changes.

**Note:** Name may only contain 32 characters (letters, numbers, single hyphens or space).

### AUDIO MIX Tab

This tab allows you to set Audio mixing function to ON/OFF, select audio sources to be used to mixing audio output, select ducking master and set the ducking parameters.

DUCKING MASTER SELECT

RX IN

TX IN

MIXING ENABLED

MIXER SETTINGS

RX IN

RX IN: 0  
0% 100%

TX IN

TX IN: 0  
0% 100%

HDMI IN: 0  
0% 100%

DUCKING SETTINGS

ATTACK TIME: 0  
0ms 1000ms

RELEASE TIME: 0  
0ms 1000ms

DUCKING TRIGGER LEVEL  
LOW HIGH

DUCKING LEVEL  
1:1 100:1

- **MIXING ENABLED:** Click the button to set audio mixing function to ON/OFF. The default setting is OFF.

When MIXING ENABLED is set to OFF, all the sliders and buttons are grey and cannot be set. When MIXING ENABLED is set to ON, you can set the following items

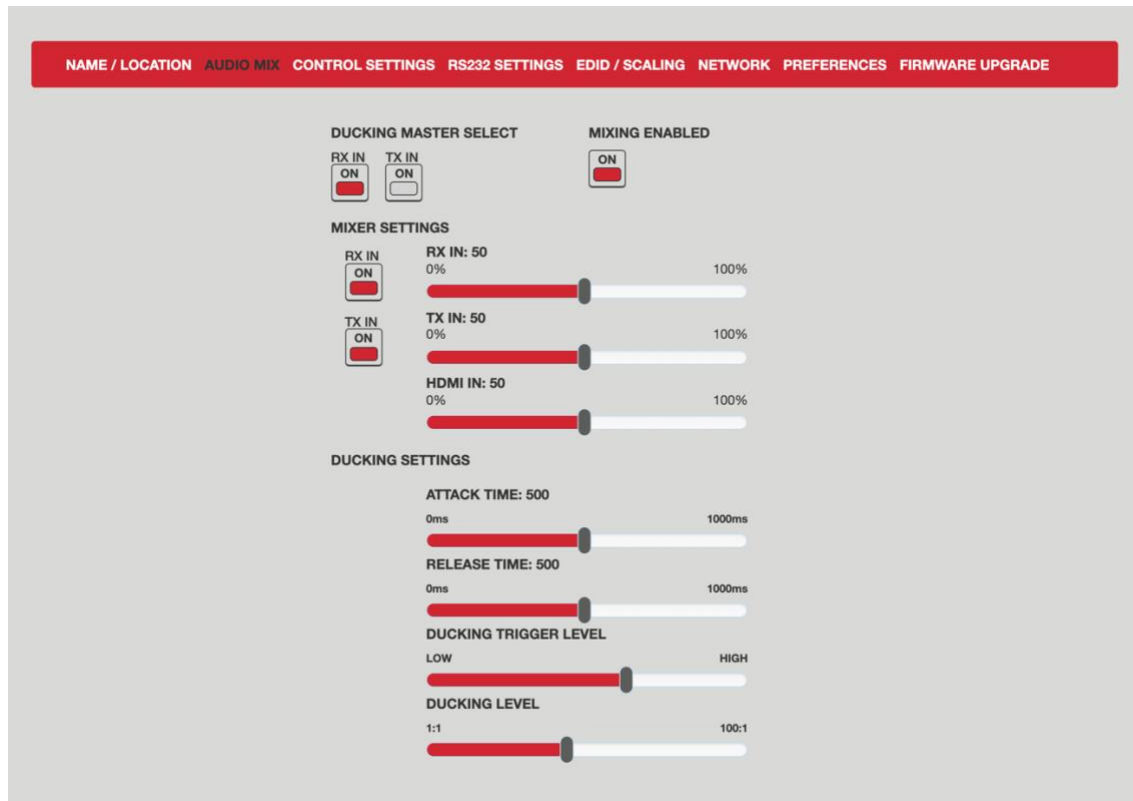

- **DUCKING MASTER SELECT:** Click the button to select one AUDIO INPUT as a ducking master from TX IN and RX IN. The default setting is RX IN.
- **MIXER SETTINGS:**
  - 1) **RX IN/TX IN button:** Click the corresponding button to select/deselect one AUDIO input to mix.  
**Note:** The selected ducking master audio input cannot be deselected.
  - 2) **RX IN/TX IN/HDMI IN:** Use the slider to adjust the volume of the three signals in mixed audio separately. The default settings of the three signals are all 50%.
- **DUCKING SETTINGS:**
  - 1) **ATTACK TIME:** Use the slider to adjust the attack time after ducking master threshold is passed. The default setting is 500ms.
  - 2) **RELEASE TIME:** Use the slider to adjust the release time after ducking master threshold is not exceeded. The default setting is 500ms.
  - 3) **DUCKING TRIGGER LEVEL:** Use the slider to adjust the trigger level of ducking. The lower the level is set, the easier the ducking is triggered.
  - 4) **DUCKING LEVEL:** User the slider to set the volume ratio of the master audio and other audio inputs in mixed audio. The larger the ratio is set, the lower the volume of other audio inputs when the main master audio input.

## CONTROL SETTINGS TAB

This tab allows you to set the display control, power sync mode and video switching mode.

NAME / LOCATION AUDIO MIX CONTROL SETTINGS RS232 SETTINGS EDID / SCALING NETWORK PREFERENCES FIRMWARE UPGRADE

DISPLAY CONTROL

IR

SEND 2<sup>nd</sup> IR OFF COMMAND

1000 DELAY (100-10000MS) FOR 2<sup>nd</sup> IR OFF

AUDIO MUTE

ALL MUTE

PAGING

POWER SYNC

ON

OFF

VIDEO SWITCHING

AUTO

MANUAL

Cancel Apply

**DISPLAY CONTROL:** select the display to be controlled via CEC, RS232 or IR. The default setting is IR.

### In IR mode:

- 1) **SEND 2<sup>nd</sup> IR OFF COMMAND:** Click the check box to set whether to automatically send or not to send the 2<sup>nd</sup> IR off command to the display automatically after the delay time. The default setting is checked.
- 2) **DELAY (100-10000MS) FOR 2<sup>nd</sup> IR OFF:** Set the delay time for the 2<sup>nd</sup> IR off command to be sent to the display automatically after the 1<sup>st</sup> IR command has been sent. The default setting is 1000ms.

### • POWER SYNC

- 1) **ON:** Set power sync function to ON.
  - 2) **OFF:** Set power sync function to OFF.
- The default setting is ON.

### • VIDEO SWITCHING:

- 1) **AUTO:** Check the box to set automatically video switching source to enable.
  - 2) **MANUAL:** Check the box to set manually video switching to enable.
- The default setting is AUTO.

- **Apply/Cancel:** Save or cancel the setting changes.

## EDID/SCALING Tab

This tab allows you to configure each input EDID and the output resolution.

- **INPUT EDID:** Click the drop-down menu to select a specific EDID. The default INPUT EDID is 3840 x 2160@30Hz 2CH-no HDR.
- **Output Resolution:** Click the drop-down menu to select a compatible resolution for connected display. By default, the Output resolution is set to auto.
- **Apply/Cancel:** Save or cancel the setting changes.

### RS232 SETTINGS Tab

This tab allows you to define the RS232 display control commands. If a display requires hex commands, make sure the Hex box is checked.

- **DISPLAY BRAND/MODEL:** Define the display name.
- **BAUD RATE:** Select the baud rate necessary to communicate with the display. Available baud rates are: 4800, 9600, 19200, 38400, 57600 and 115200.
- **COMMAND ENDING:** Select the command ending after each RS232 command. Available command endings are: NONE, carriage return, line feed, and carriage return and line feed.
- **DISPLAY ON COMMAND:** Enter the RS232 command to turn on the display.



- **DISPLAY OFF COMMAND:** Enter the RS232 command to turn off the display.
- **DISPLAY INPUT COMMAND:** Enter the RS232 command to switch to the input which is connected to the receiver.
- **POWER STATUS COMMAND:** Enter the RS232 command to get the display working status.
- **LAMP HOURS COMMAND:** Enter the RS232 command to get the lamp system working hours of the display.
- **INPUT DELAY (1-120 SECONDS):** Enter the delay time in seconds between the DISPLAY ON and DISPLAY INPUT command. This delay may be between 1 and 120 seconds.
- **Apply/Cancel:** Save or cancel the setting changes.

## NETWORK Tab

This tab allows you to select between the dynamic and static IP addressing.

- **DHCP:** When enabled, the IP address of the kit is assigned automatically by the DHCP server connected.
- **STATIC:** When the kit fails to obtain an IP address from the network connected, select “STATIC” to set up the IP address manually.
- **Apply/Cancel:** Save or cancel the setting changes.

**Note:** The default setting is DHCP. If the kit fails to obtain an IP address from the network, or is set as “Static”, ensure your PC is in the same network segment as the kit.

## PREFERENCES Tab

This tab allows you to change login password and input name.

- **INPUT NAME:** Change input names of INPUT 1-4.
- **PASSWORD:** Change the password of the login name user and admin. The default password for user is “user”, for admin is “admin”.
- **AUDIO INPUT NAME:** Change AUDIO input names of HDMI, TX AUDIO and RX AUDIO.
- **Apply/Cancel:** Save or cancel the setting changes.

**Note:**

- The new password must contain 4 to 16 characters (alphanumeric only).
  - The length of name is limited to 16 characters.
  - **Custom Web UI Logo:** Click “Upload” to select a PNG image from local PC to upload. The logo on web UI will be changed to the image uploaded.
- Note:** You must upload an image in PNG format with a resolution of 292x80 pixels.

## FIRMWARE UPGRADE Tab

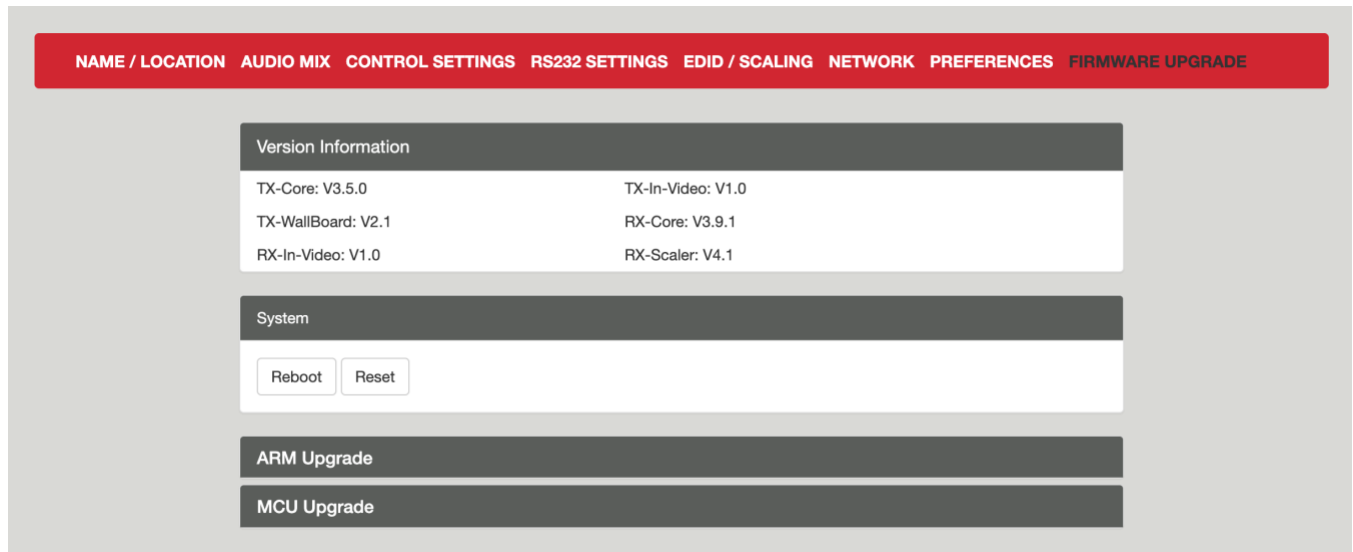

This tab allows you to obtain the current firmware information and upgrade firmware to the latest version.

### To upgrade the ARM module:

1. Click "Browse" for the bin file.
2. Click "Upgrade" to start the ARM upgrade.



The following window will pop up to indicate the ARM upgrade is successful. Please wait for about 8 minutes, then refresh and login.

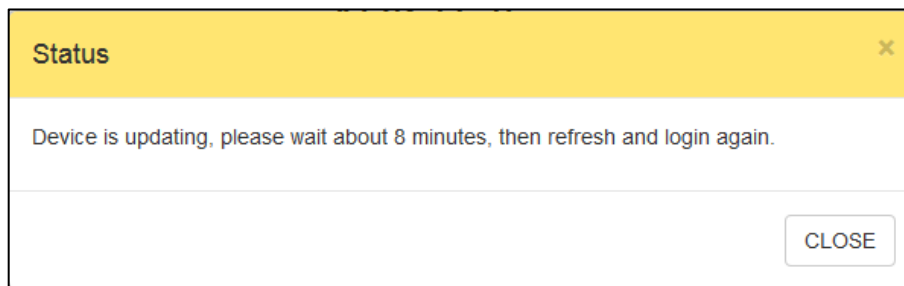

### To upgrade the MCU module:

1. Click "Browse" for the upgrade file.
2. Click "Upgrade" to start the MCU upgrade.



3. The following window will pop up to indicate the MCU upgrade is successful. Please refresh and log in again.

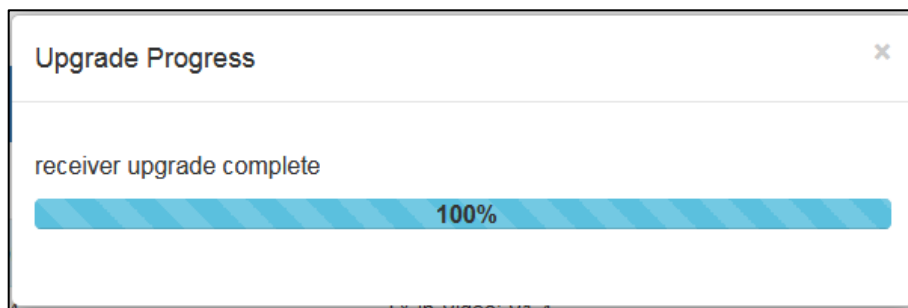

**Note:** Please do not power off the device during the upgrade process.

## Warranty Terms and Conditions

---

For the following cases we shall charge for the service(s) claimed for the products if the product is still remediable and the warranty card becomes unenforceable or inapplicable.

1. The original serial number (specified by us) labeled on the product has been removed, erased, replaced, defaced or is illegible.
2. The warranty has expired.
3. The defects are caused by the fact that the product is repaired, dismantled or altered by anyone that is not from an authorized service partner. The defects are caused by the fact that the product is used or handled improperly, roughly or not as instructed in the applicable User Guide.
4. The defects are caused by any force majeure including but not limited to accidents, fire, earthquake, lightning, tsunami and war.
5. The service, configuration and gifts promised by salesman only but not covered by normal contract.
6. We preserve the right for interpretation of these cases above and to make changes to them at any time without notice.



© Copyright 2022. Hall Technologies  
All rights reserved.

1234 Lakeshore Drive, Coppell, TX 75019  
halltechav.com / support@halltechav.com  
(714)641-6607