

Legend

- RR Remote Start Relay
- ⊗ Remote Alarm
- ⊙ Motor Starter
- ⊕ Meg-Ohm Meter
- ⊖ Sheilded Wires
- Customer Provided Wiring

Drawn By: KM Delamater

Checked: R. Zelm

**GP500-MU-AS
Typical Wiring Diagram**

Date: 2/14/2020

Scale: None

Remote LED Plate for Models:
 GP8013-MU-AS
 GP8013-CG-AS

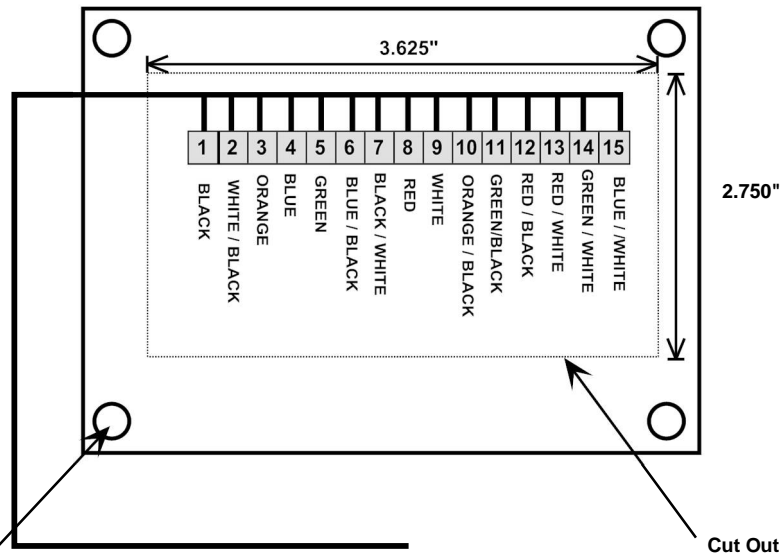
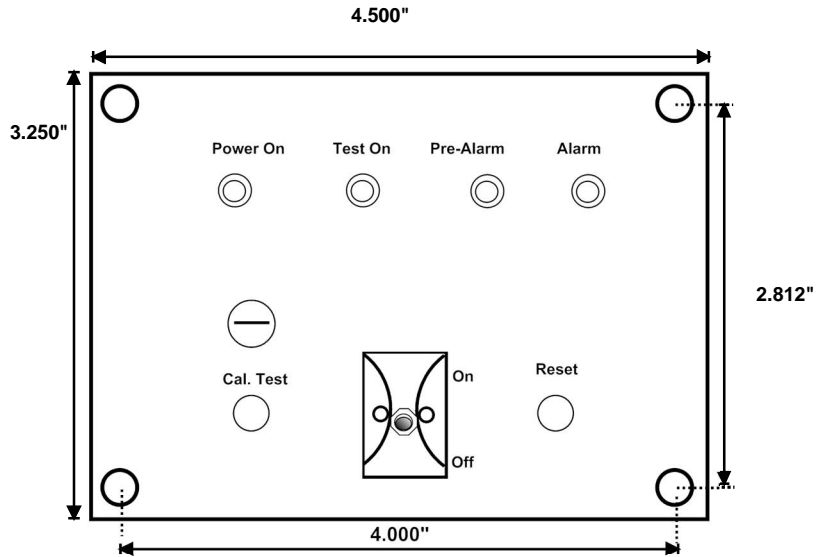

3/16" (4x)

Hook-up to Power Supply

Column Wire #	Color Code
TB11	Blue
TB12	White/Black
TB13	Orange
TB14	Black
TB20	Blue w/Black Stripe
TB21	Black w/White Stripe
TB22	Red w/ Black Stripe
TB23	Green w/ Black Stripe
TB24	Orange w/ Black Stripe
TB25	Blue w/White Stripe
TB26	Red w/ White Stripe
TB27	Green w/ White Stripe
TB28	Green
TB29	White
TB30	Red



MotorGuard Installation Instructions Model: GP500-MU-AS

Input power 120 +/- 10% VAC 50/60 Hz @ .5A Max.

Test Voltage 500 VDC @ 200uA Max.

Unit to be installed in a "clean" and "dry" environment, in a switchgear or a NEMA type enclosure.

Ambient Temp. -20° F to 140° F

Maximum relative humidity 80% for temperatures up to 31° C decreasing linearly to 50% relative humidity at 40°

Pollution degree 2 Altitude up to 2000m

Wiring: 16 AWG, 600V switchboard wire

MEASUREMENT CATEGORY III

NOTE: If unit is installed in an enclosure, please skip to # 4.

1. The device is a Class 1 according to IEC 61010-1 for electric safety and chassis must be grounded to the main protective earth in the end application.
2. Position din rail inside motor starter housing for clearance and ease of wire installation. Drill four (4) holes for #10 screws and install rail(s). Snap MotorGuard onto rail. If back pan mounting is desired drill two holes for #10 screws and mount MotorGuard using holes provided in the enclosure.
3. Mount the meter according to drawings supplied.
4. To install the remote LED/Switch assembly (GP8013-MU-AS), there are 2 ways to mount the assembly.
 - Option A) When the optional EZ mount bracket (Part number GP8013-EZBK) is provided, drill (4) 1/8" holes to mount the bracket and (1) 5/8" hole for the cable.
 - Option B) For a flush mount drill four (4) 1/8" holes and cut out a 4.75" x 3.625" clearance hole for the assembly. Mount the assembly using the mounting holes provided in the panel.
5. Install warning stickers (provided with the MotorGuard) on terminal boxes of equipment to be tested.

All wiring should be 16/18 AWG. Torque requirements 1.3 NM or 1.0 FT-LBF.

6. Connect terminals (1) and (2) to input power source (see wiring diagram & nameplate).
7. Locate a dry normally closed auxiliary contact on the motor starter contactor (one may need to be installed). Connect terminals (3) and (4) to the normally closed aux. contact (see wiring diagram).
8. Connect terminals (5), (6), and (7) to an alarm panel or PLC inputs, if required.
9. Connect terminals (8), (9) and (10) to the motor starter circuit to lockout the equipment after an alarm, if so desired



MotorGuard Installation Instructions Model: GP500-MU-AS

Input power 120 +/- 10% VAC 50/60 Hz @ .5A Max.

Test Voltage 500 VDC @ 200uA Max.

Unit to be installed in a "clean" and "dry" environment, in a switchgear or a NEMA type enclosure.

Ambient Temp. -20° F to 140° F

Maximum relative humidity 80% for temperatures up to 31° C decreasing linearly to 50% relative humidity at 40°

Pollution degree 2 Altitude up to 2000m

Wiring: 16 AWG, 600V switchboard wire

MEASUREMENT CATERGORY III

10. Connect terminals (11) through (14) to the remote LED/switch assembly. Terminal (11) is the yellow LED positive output; terminal (12) is the red flashing LED positive output; terminal (13) is the yellow flashing LED positive output; and terminal (14) is the LED common.
11. Connect the (ground) terminal (15) to the mechanical ground of the equipment being tested.
12. Connect the (test) terminal (16) to the B phase winding in an AC motor system, or the positive lead in a DC motor system.
13. Connect (pre-alarm) terminals (17), (18), and (19) to an alarm panel or PLC, if desired.
14. Connect terminals (20) through (30) to the remote LED/Switch assembly, terminal (20) and (21) is the "reset" button. Terminal (22), (23) and (24) are the "Cal. /Test pushbutton. Terminal (25), (26) and (27) are the "Cal." Pot adjust. Terminal (28) is the green LED positive output. Terminal (29) and (30) are the "on/off" switch.
15. Connect terminals (31) and (32) to the meter. Observe correct polarity; terminal (31) is positive and terminal (32) is negative. NOTE: When using 4-20mA transducer option, wire transducer input in series with meter connections. (see wiring diagram).
16. Proceed with operating instructions.



MotorGuard Operating Instructions Model: GP500-MU-AS

Input power 120 +/- 10% VAC 50/60 Hz @ .5A Max.

Test Voltage 500 VDC @ 200uA Max.

Unit to be installed in a "clean" and "dry" environment, in a switchgear or a NEMA type enclosure.

Ambient Temp. -20° F to 140° F

Maximum relative humidity 80% for temperatures up to 31° C decreasing linearly to 50% relative humidity at 40°

Pollution degree 2 Altitude up to 2000m

Wiring: 16 AWG, 600V switchboard wire

MEASUREMENT CATEGORY III

1. After installation is completed on the unit, apply voltage to the MotorGuard. Observe the green "Power On" and the yellow "Test On" LED are illuminated.
 - A. Start the motor being tested and observe that the "TEST ON" yellow LED will turn off and the meter indicator will read infinity.
 - B. Stop the motor, the yellow "TEST ON" LED should be illuminated, and the meter indicator will now read the value of the motor's insulation condition.
2. Press the cal./test button at this time to check proper operation of the MotorGuard and to see if the meter is calibrated correctly. Hold the cal. /test button for approximately 10 to 15 seconds. The meter indicator should first go to the "test" position carrot (1 meg-ohm). Observe that the yellow flashing pre-alarm LED starts flashing approximately 5 to 10 seconds after pressing and holding the test button. (The pre-alarm contacts will change state when the yellow LED begins flashing and automatically reset when the yellow LED stops flashing). Then the MotorGuard should trip on an alarm condition and the red "ALARM" LED should start flashing. The alarm and lockout contacts should now have changed state showing an alarm and preventing the motor from starting if the lockout circuit is used.
3. Press the reset button. The MotorGuard should return to a test condition. The red "ALARM" LED should stop flashing, while the yellow "TEST ON" LED should be illuminated. The meter indicator will now be showing the insulation value of the motor being tested.
4. The system is now ready for normal operation.

EQUIPMENT MAINTENANCE

Only Qualified personnel shall perform maintenance of this device.

Before use all cables shall be checked for cracking or damage.

Only a 1.5A 250V AGC fuse shall be used with this device.

WARNING:

Before servicing any equipment being tested with a MotorGuard system, one must turn off and lockout the MotorGuard power and short the motor windings to ground in order to remove any possible residual capacitive charge that may be present in the unit.



Technical Support: 800-778-5689

Models: GP500-MU-AS
GP500-G-AS
GP500-CG-AS
GP1000-ARL-AS

FRONT VIEW

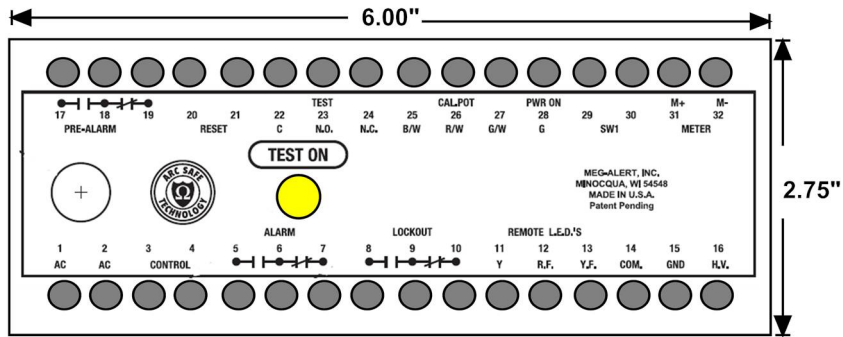

SIDE VIEWS

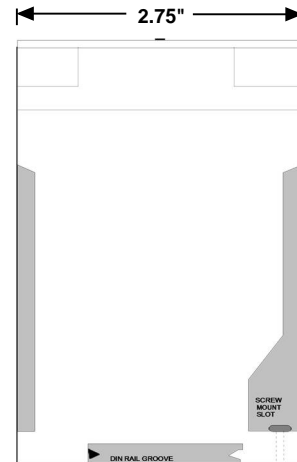
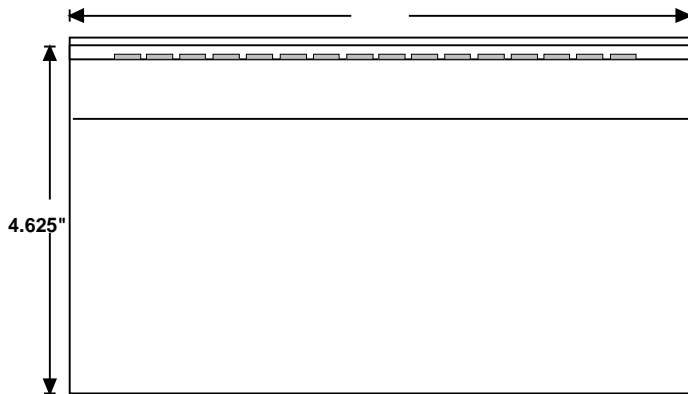

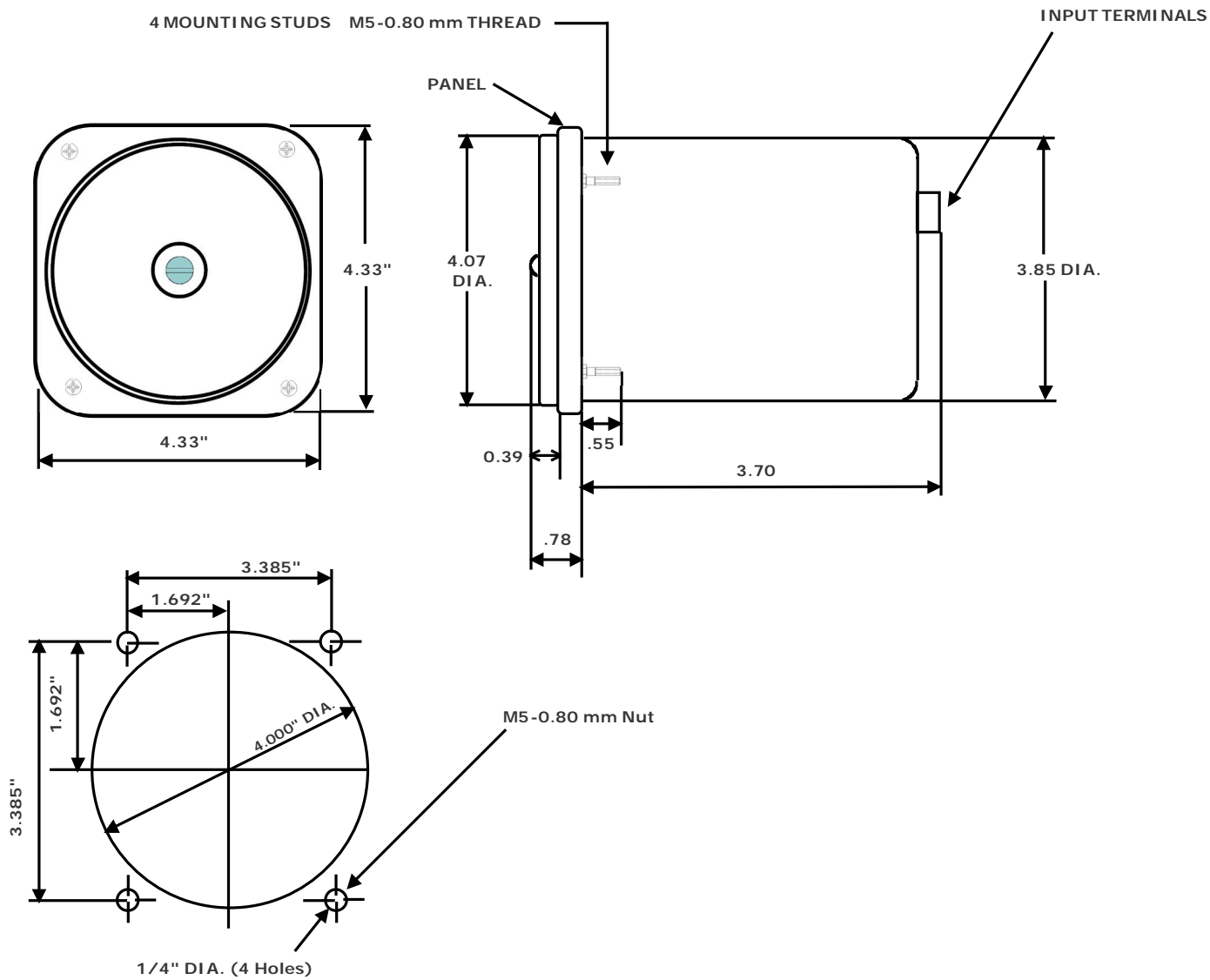

1 % Switchboard Meter Dimensions GP7000 Series 	DRAWN BY		DATE
	KM Delamater		2/5/2018
	CHECKED R. Zelm	SCALE None	SHEET NO. 1