

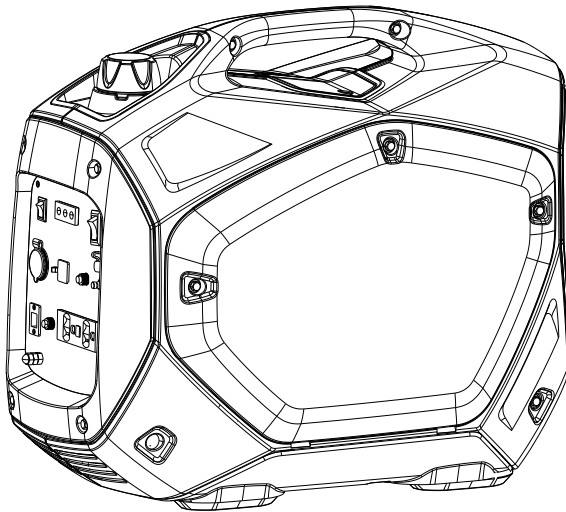

## PORTABLE INVERTER GENERATOR

GEN2000W120V



READ AND UNDERSTAND THE MANUAL PRIOR TO USING.

2018-08-06 (REV:01)

## INTRODUCTION

Thank you for purchasing this Inverter Generator. Before using this product, please read this manual thoroughly and follow the instructions carefully.

### CONTENTS

SAFETY INFORMATION.....	2
CONTROLS & FEATURES.....	4
PRE-OPERATION CHECK.....	7
OPERATION .....	9
PERIODIC MAINTENANCE.....	14
TROUBLESHOOTING .....	17
STORAGE.....	18
SPECIFICATION.....	19
WIRING DIAGRAM.....	20

## WARNING

READ AND UNDERSTAND THIS MANUAL COMPLETELY BEFORE OPERATING THE GENERATOR.

## SAFETY INFORMATION

### EXHAUST FUMES ARE POISONOUS

Never operate the generator in a closed area. It may cause unconsciousness or death within a short period of time.

Operate the generator in a well ventilated area.

### FUEL IS HIGHLY FLAMMABLE AND POISONOUS

Always turn off the engine when refueling.

Never refuel while smoking or near an open flame.

Take care not to spill any fuel on the engine or muffler when refueling.

If you swallow any fuel, inhale fuel vapor, or allow any to get in your eyes, seek assistance immediately. If any fuel spills on your skin or clothing, immediately wash with soap and water and change your clothes.

When operating or transporting the generator, be sure it is kept upright. If it tilts, fuel may leak from the carburetor or fuel tank.

### ENGINE AND MUFFLER MAY BE HOT

Place the generator in a place where passers-by or children are not likely to touch the generator.

Avoid placing any flammable materials near the exhaust outlet during operation.

Keep the generator at least 3 feet from buildings or other equipment, or the engine may overheat.

Avoid operating the engine with a dust cover.

Be sure to carry the generator only by its carry handle.

Put the machine on the flat ground, allowing generator to eliminate heat freely.

### ELECTRIC SHOCK PREVENTION

Never operate the generator in rain or snow.

Never touch the generator with wet hands or electrical shock will occur.

Be sure to ground (earth) the generator. **FIG.1**

### NOTE:

Use ground (earth) lead of sufficient current capacity.

Diameter: 0.12mm (0.005 in)/ampere –8AWG Wire

EX: 10 Ampere –1.2mm (0.055 in)

FIG.1

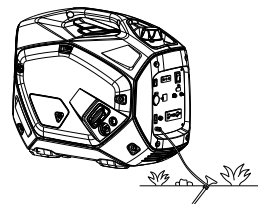

## CONNECTION NOTES

Do not connect the generator to commercial power outlet.

Do not connect the generator in parallel with any other generator.

## SAFETY SYMBOLS



Caution - The user should be aware of a general hazard.



Dangerous Voltage



Flammable



Hot Surface - Do not touch.

# CONTROL & FEATURES

## GENERATOR OVERVIEW (FOR ELECTRIC START TYPE)

- |                                    |                               |                        |
|------------------------------------|-------------------------------|------------------------|
| (1) Fuel tank                      | (2) Spark plug                | (3) Muffler            |
| (4) Carrying handle                | (5) Choke lever               | (6) Air filter         |
| (7) Fuel pump                      | (8) Fuel cock                 | (9) Recoil starter     |
| (10) Oil filler cap                | (11) Fuel tank cap            | (12) Fuel filter       |
| (13) AC pilot light                | (14) Overload indicator light | (15) Oil warning light |
| (16) Economy control switch        | (17) DC 12V output            | (18) USB output        |
| (19) Auto Gen Start                | (20) Ground (earth) terminal  | (21) AC protector 20A  |
| (22) AC receptacle                 | (23) DC protector             | (24) Output reset      |
| (25) Engine start (EC5 receptacle) | (26) Engine switch            |                        |

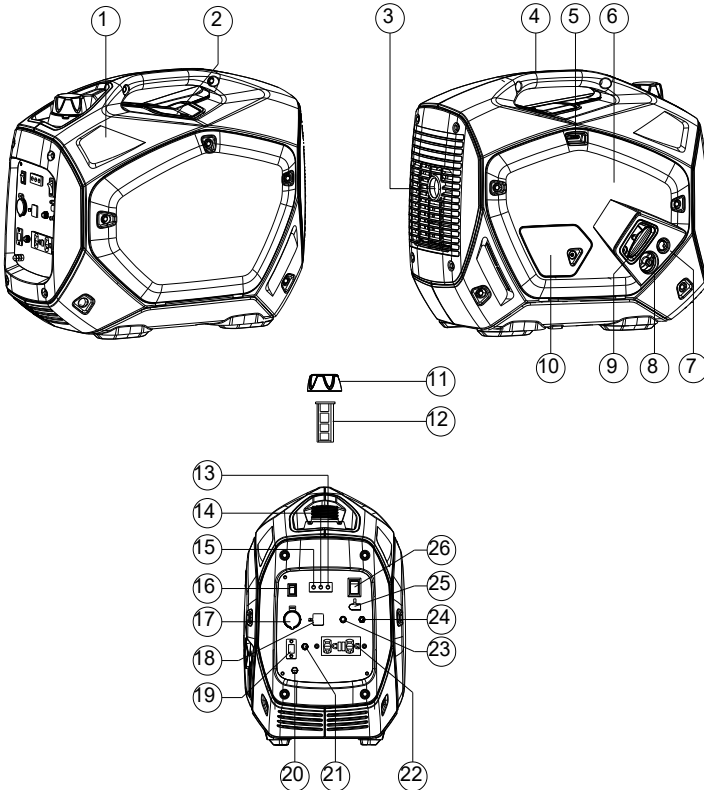

## OIL WARNING SYSTEM

When the oil level falls below the lower level, the engine stops automatically. Unless you refill with oil, the engine will not start again.

### FIG.2

## ENGINE AND FUEL COCK SWITCH

The engine switch controls the ignition system. **FIG.3**

① **ON** (run)

Ignition circuit is switched on. The engine can be started.

② **OFF**(stop)

Ignition circuit is switched off. The engine will not run.

## ELECTRIC START SWITCH

The engine switch controls the ignition system. **FIG.4**

① **RUN**

Ignition circuit is switched on. The engine can be started.

② **STOP**

Ignition circuit is switched off. The engine will not run.

③ **START**

Starting circuit is switched on. The starter motor starts.

## ECONOMY CONTROL SWITCH

When the economy control switch is turned **ON**, the economy control unit will control the engine speed according to the connected load. The results are more efficient fuel consumption and less noise. **FIG.5**

## DC CIRCUIT PROTECTOR

The DC circuit protector turns off automatically when the load exceeds the generator's rated output. **FIG.6**

### CAUTION:

Reduce the load to within specified generator's rated output if the DC circuit protector turns off.

FIG.2

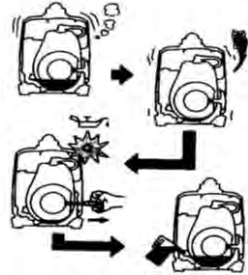

FIG.3

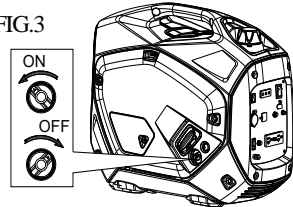

FIG.4

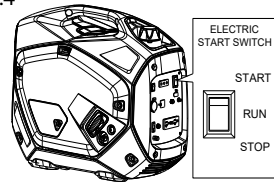

FIG.5

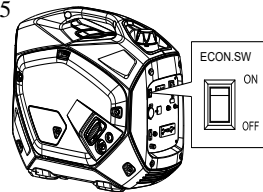
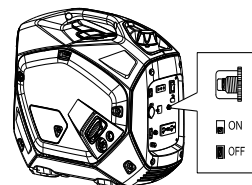

FIG.6



## OUTPUT RESET

Push reset button for 2 seconds. The generator will recover and produce AC power. **FIG.7**

**NOTE:** \_\_\_\_\_

Reduce the load on the generator to ensure that the total load is within the rated power.  
\_\_\_\_\_

## AUTO GEN START

The auto gen start controls the ignition system. **FIG.8**

When the circuit of this plug is connected the starter motor starts

When the circuit of this plug is disconnected the engine will stop

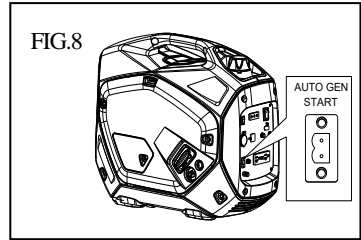
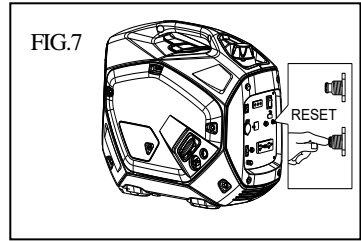

## PRE-OPERATION CHECK

### NOTE:

Pre-operation checks should be made each time the generator is used.

## CHECK ENGINE FUEL

Make sure there is enough fuel in the tank. **FIG.9**

If fuel is low, refill with unleaded automotive gasoline.

Be sure to use the fuel filter screen on the fuel filter neck.

Recommended fuel: Unleaded gasoline.

Fuel tank capacity: (see page 19)

### WARNING:

Do not refill tank while engine is running or hot.

Close fuel petcock before refueling.

Be careful not to allow dust, dirt, water or other foreign objects into fuel.

Do not fill above the top of the fuel filter or it may overflow when the fuel heats up later and expands.

Wipe off spilled fuel thoroughly before starting engine.

Keep away from open flame.

## CHECK ENGINE OIL

Make sure the engine oil is at the upper level of the oil filler hole. Add oil as necessary. **FIG.10**

Remove oil filler cap and check the engine oil level.

If oil level is below the lower level line, refill with recommended oil to upper level line. Do not screw in the oil filler cap when checking oil level.

Change oil if contaminated.

Oil capacity: (see page 19)

Recommended engine oil: 10W-30

API Service "SJ" **FIG.11**

FIG.9

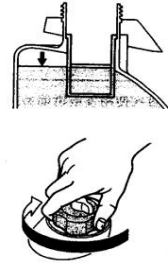

FIG.10

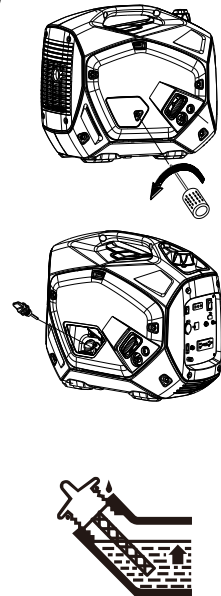
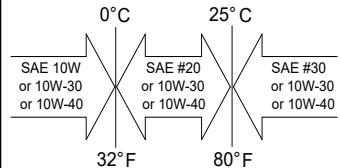

FIG.11





## GROUND (Earth)

### WARNING:

It is important to properly ground your generator before using.

Use an 8AWG wire and a small metal earth spike. The wire and earth spike are not supplied with the unit. **FIG.12**

FIG.12

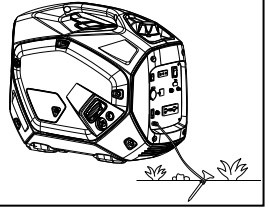

## CONNECT BATTERY (for electric starting system)

- (a) The battery for electric starter should be fixed on the handle of generator.

### FIG.13

- (b) Connect the battery to the socket on the control panel with the cable for battery. **FIG.14**

FIG.13

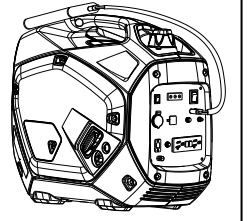

### NOTE:

Make sure the battery is fully charged before using.

Avoid poor contact between battery and socket on control panel.

The battery also can be used as a power bank, please find the details in the manual for battery.

FIG.14

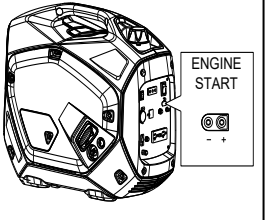

# OPERATION

**NOTE:**

The generator has been shipped without engine oil. Fill with oil or it will not start.

Do not tilt the generator when adding engine oil. This could result in overfilling and damage to the engine.

## STARTING THE ENGINE

**NOTE:**

Before starting the engine, do not connect electric appliances.

### A. Recoil start

1. Turn the fuel cock lever to the **ON** position. **FIG.15**
2. Turn the electric start switch to the **RUN** position. **FIG.16**
3. When starting the generator for the first time, press the primer bulb 6 times before attempting to start. **FIG.17**
4. Turn the choke lever to the |  | **CHOKE** position. Not necessary if the engine is warm. **FIG.18**
5. Pull the starter handle slowly until resistance is felt. This is the "Compression" point. Return the handle to its original position and pull swiftly. Do not fully pull out the rope. After starting, allow the starter handle to return to its original position while still holding the handle. Grasp the carrying handle firmly to prevent the generator

FIG.15

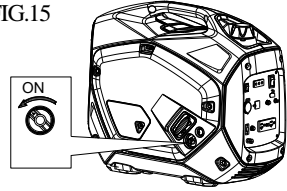

FIG.16

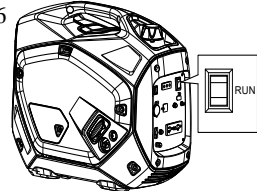

FIG.17

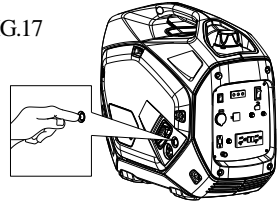

FIG.18

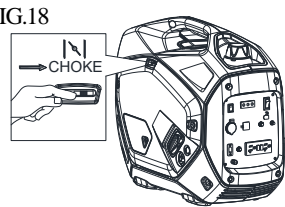
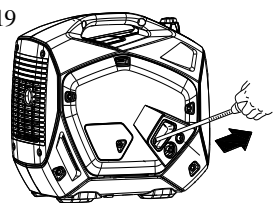



FIG.19



from falling over when pulling the recoil starter. **FIG.19**

6. Warm up the engine.
7. Turn the choke lever back to the |  | **RUN** position.

**FIG.20**

8. Warm up the engine without a load for a few minutes.

**B. Electric start**

1. Make sure the fuel cock lever is in the **ON** position.
2. Make sure the choke lever is in the |  | **RUN** position.
3. Turn the engine switch to the **START** position. **FIG.21**
4. Turn the engine switch to the **RUN** position. **FIG.22**
5. Warm up the engine without a load for a few minutes.

**FIG.20**

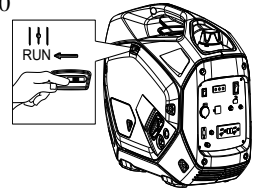

**FIG.21**

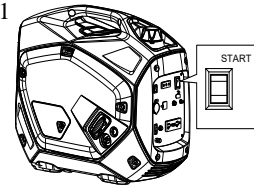

**FIG.22**

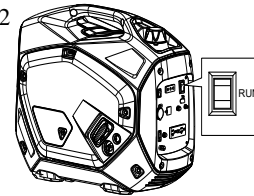

**C. Auto start**

1. Make sure the fuel cock lever is in the **ON** position.
2. Make sure the choke lever is in the |  | **RUN** position.
3. Make sure the engine switch is in the **RUN** position.
4. Connect the cable to Auto Gen Start plug. As soon as the generator receives the start signal, the generator will start. If the generator does not start successfully it will try to start again. Generator will disconnect the circuit when the generator does not start after three times. **FIG.23**

**FIG.23**

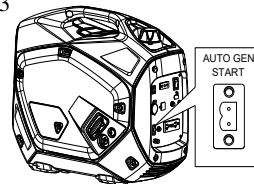

## USING ELECTRIC POWER

### 1. AC APPLICATION

- (a) Check the AC pilot lamp for proper voltage.
- (b) Turn off the switch(es) of the electrical appliance(s) before connecting to the generator.
- (c) Insert the plug(s) of the electrical appliance(s) into the outlet. **FIG.24**

#### CAUTION:

- Be sure the electric appliance is turned off before plugging in.
- Be sure the total load is within generator's rated output.
- Be sure the socket load current is within socket rated current.
- The economy control switch must be turned to **OFF** when using electric devices that require a large starting current, such as a compressor or a submergible pump. **FIG.25**

### 2. OVERLOAD INDICATOR LIGHT

The overload indicator light comes on when overloaded, short circuit, or voltage is out of operating tolerance, overheats, or the AC output voltage rises. The electronic breaker will then activate, stopping power to the generator in order to protect the generator and any connected electric devices. The output pilot light (green) will flicker and the overload indicator light (red) will turn on, then the engine will stop running. If so follow the following steps: **FIG.26**

- (a) Turn off any connected electric devices and stop the engine.
- (b) Reduce the total wattage of connected electric devices to within the application range.
- (c) Check for blockages in the cooling air inlet and around the control unit. If any blockages are found, remove.
- (d) After checking, restart the engine. **FIG.27**

#### CAUTION:

- The generator AC output automatically resets when the engine is stopped and then restarted.
- The overload indicator light may come on for a few seconds at first when using electric devices that require a large starting current, such as a compressor or a submergible pump. This is not a malfunction.

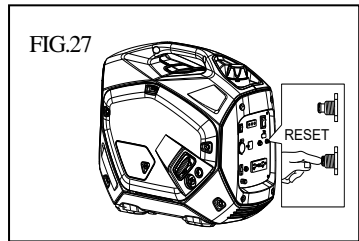
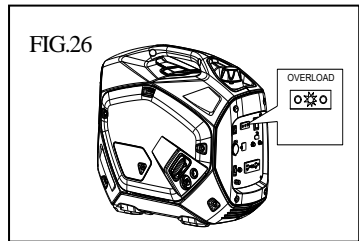
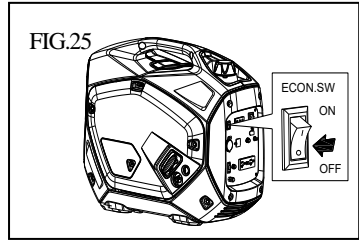
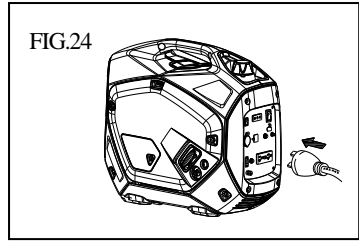

### 3. DC APPLICATION (option)

This applies to 12V battery charging only.

- (a) Disconnect the leads for the battery.

Fully loosen the battery fluid filler cap.

Fill distilled water to the upper limit, if the battery fluid is low level.

Measure the specific gravity for the battery fluid by using the hydrometer, and calculate the charging time according to the table shown on right side.

The specific gravity for the fully charged battery shall be within 1.26 to 1.28. It is recommended to check every hour. **FIG.28**

- (b) Connect the DC output socket and the battery terminals using the charging leads. The leads must be connected making sure the (+) and (-) are correct. **FIG.29**

**CAUTION:** \_\_\_\_\_

- Be sure the economy control switch is turned **OFF** while charging the battery.
- \_\_\_\_\_

**FIG.28**

Aim for specific gravity and charging time

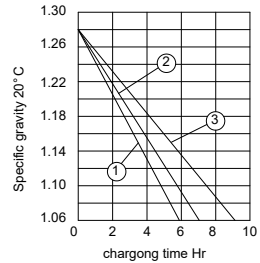

Battery capacity  
1. 30AH 20HR  
2. 35AH 20HR  
3. 47AH 20HR

**FIG.29**

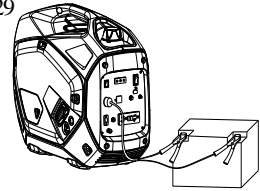

## STOPPING THE ENGINE

1. Turn off the power switch of the electric device or disconnect any electric devices. **FIG.30**
2. Turn the engine switch to **STOP** position. **FIG.31**
3. Turn the fuel cock lever to **OFF**. **FIG.32**

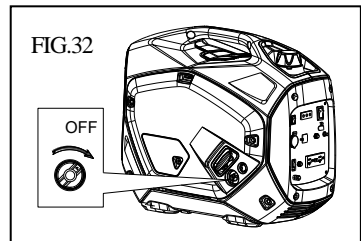
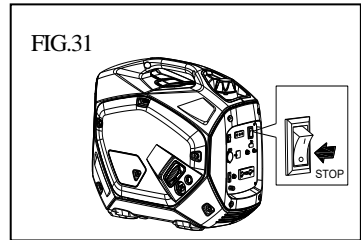
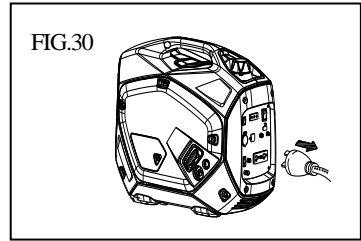

# PERIODIC MAINTENANCE

## MAINTENANCE CHART

Item	Remarks	Pre-operation check (daily)	Initial 1 months or 20 Hr	Every 3 months or 50Hr	Every 6 months or 100Hr	Every 12 months or 300Hr
Spark Plug	Check condition adjust gap and clean. Replace if necessary.			●		
Engine Oil	Check oil level	●				
	Replace		●		●	
Oil filter	Clean oil filter				●	
Air Filter	Clean. Replace if necessary.			●		
Fuel Filter	Clean fuel cock filter. Replace if necessary				●	
Choke	Check choke operation	●				
Valve Clearance	Check and adjust when engine is cold.					●
Fuel Line	Check fuel hose for crack or damage. Replace if necessary.	●				
Exhaust System	Check for leakage. Retighten or replace gasket if necessary	●				
	Check muffler screen. Clean / replace if necessary.					●
Carburetor	Check choke operation	●				
Cooling system	Check fan damage.					●
Starting system	Check recoil starter operation.	●				
Idle speed	Check and adjust engine idle speed					●
Fittings / Fasteners	Check all fittings and fasteners correct if necessary.				●	
Crankcase breather	Check breather hose for cracks or damage. Replace if necessary					●
Generator	Check the pilot light comes on	●				

Regular maintenance is important for the best performance and safe operation.

## ENGINE OIL REPLACEMENT

1. Place the generator on a level surface and warm up the engine for several minutes. Then stop the engine and turn the fuel cock knob to **OFF**. Turn the fuel tank cap air vent knob counterclockwise to the **CLOSED** position. FIG.33
2. Loosen the screw and remove the cover.
3. Remove the oil filler cap.
4. Place an oil pan under the engine. Tilt the generator to drain the oil completely. FIG.34
5. Replace the generator on a level surface.
6. Add engine oil to the upper level. FIG.35
7. Replace the oil filler cap.
8. Replace the cover and tighten the screw

Recommended engine oil: (**see page 19**)

API Service "SJ"

### CAUTION:

Be sure no foreign material enters the crankcase.

Do not tilt the generator when adding engine oil. This could result in overfilling and damage to the engine

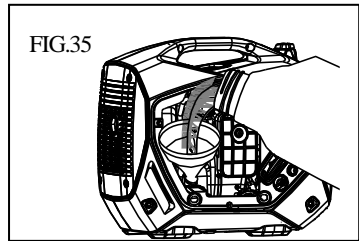
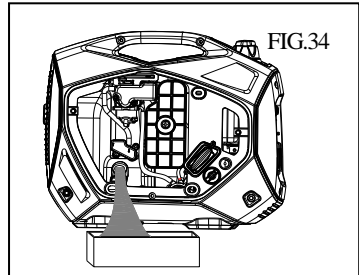
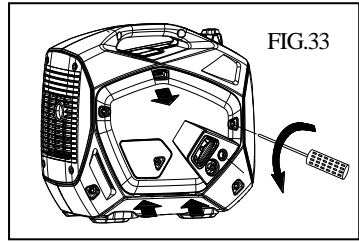

## AIR FILTER

Cleaning your air filter needs to be part of your maintenance regime. The air filter ensures that the air entering the combustion chamber is as clean as possible. Contaminated air wears on the engine caused by foreign bodies and a less efficient combustion process. FIG.36

1. Remove the cover.
2. Remove the air filter cover and element.
3. Wash the element in solvent and dry.
4. Oil the element and squeeze out excess oil. The element should be wet but not dripping.
5. Insert the element into the air filter.
6. Replace the cover.

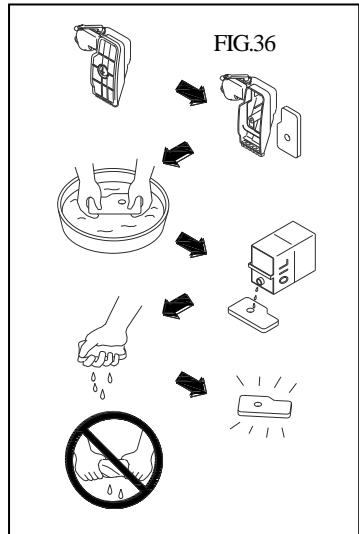



**CAUTION:** \_\_\_\_\_

The engine should never run without the element; excessive piston and/or cylinder wear may result.

---

**CLEANING AND ADJUSTING SPARK PLUG**

1. Remove the cover.
2. Check for discoloration and remove the carbon.
3. Check the spark plug type and gap.
4. Install the spark plug.
5. Replace the cover. FIG.37

**CAUTION:** \_\_\_\_\_

Standard electrode color: Tan Color.  
Standard Spark Plug: A5RTC (TORCH)  
Spark Plug Gap: 0.6-0.7 mm (0.024-0.028 in)

---

**FUEL TANK FILTER**

1. Remove the fuel tank cap and filter.
2. Clean the filter with solvent. If damaged, replace.
3. Wipe the filter and insert it. FIG.38

**WARNING** \_\_\_\_\_

Be sure the tank cap is tightened securely.

---

**MUFFLER SCREEN**

**WARNING** \_\_\_\_\_

The engine and muffler will be very hot after the engine has been run.

Avoid touching the engine and muffler while they are still hot with any part of your body or clothing during inspection or repair.FIG.39

---

FIG.37

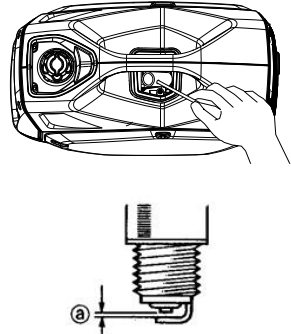

FIG.38

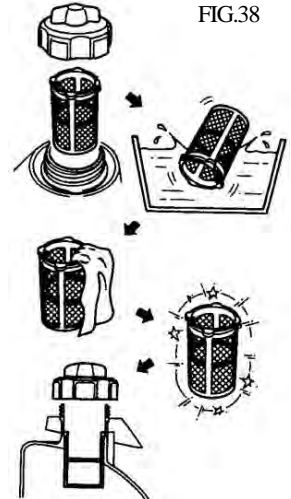
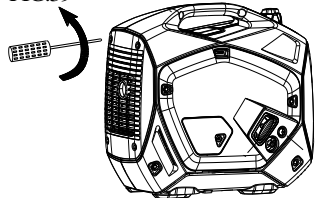
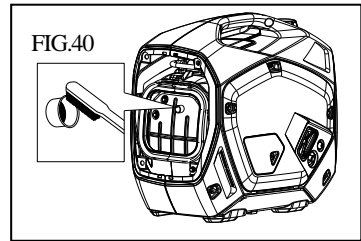

FIG.39



1. Remove the cover.
2. Remove the muffler screen.
3. Use a flathead screw driver to pry the spark arrester out from the muffler.
4. Remove the carbon deposits on the muffler screen and spark arrester using a wire brush.
5. Replace the muffler screen.
6. Replace the cover. FIG.40



## TROUBLESHOOTING

### Engine won't start

#### 1. Fuel systems

No fuel supplied to combustion chamber.

No fuel in tank...Supply fuel.

Fuel in tank...Turn fuel cock knob to **ON**.

Clogged fuel line...Clean fuel line.

Clogged carburetor...Clean carburetor.

#### 2. Engine oil system

Oil level is low...Add engine oil.

#### 3. Electrical systems

##### Poor spark

Spark plug dirty with carbon or wet...Remove carbon or wipe spark plug dry.

Faulty ignition system...Consult dealer.

#### 4. Compression insufficient

Worn out piston and cylinder....Consult dealer.

#### 5. Generator won't produce power

Safety device (AC) to "OFF" ...Stop the engine, then restart.

Safety device (DC) to "OFF" ...Press to reset the DC protector

## STORAGE

Long term storage of your machine will require some preventative maintenance to guard against deterioration.

### DRAIN THE FUEL

1. Remove the fuel tank cap, drain the fuel from the fuel tank.
2. Remove the cover, drain fuel from the carburetor by loosening the drain screw.

### ENGINE

1. Remove the spark plug, pour in about one tablespoon of SAE 10W30 or 20W40 motor oil into the spark plug hole and reinstall the spark plug.
2. Use the recoil starter to turn the engine over several times (with ignition off).
3. Pull the recoil starter until you feel compression.
4. Stop pulling.
5. Clean exterior of the generator and apply a rust inhibitor.
6. Store the generator in a dry, well-ventilated place, with the cover placed over it.
7. The generator must remain in a vertical position.

SPECIFICATION

MODEL		GEN2000W120V
GENERATOR	Type	Portable Inverter Generator
	AC Voltage	100V, 110V, 120V
	Frequency	60Hz
	Max. Output	2.0 kW
	Rated Output	1.9 kW
	Power Factor	1.0
	DC Output	12V / 4.0A 5V / 1A 5V / 2.1A(Optional)
ENGINE	Model	XY156F
	Type	Air-cooled, 4 cycle, OHV, Gasoline Engine
	Bore × Stroke mm × mm	56 × 46
	Displacement	114 cc
	Max. Output	2.5KW / 4500rpm
	Fuel	Unleaded Automobile Gasoline
	Fuel tank Capacity	0.95gal
	Rated Continuous Operation	4.6 hr (50% Load)
	Lubricating oil	SAE 10W30
	Lubricating oil Capacity	0.52 liter
	Starting System	Electric / Recoil Starter
	Ignition system	C.D.I.
	Spark Plug: Type	A5RTC (TORCH)
DIMENSION	Unit dimension L × W × H	20.66 × 11.10 × 17.32 in
	Box dimension L × W × H	21.85 × 12.6 × 18.3 in
	Unit Weight	48.5lb
	Box Weight	50lb

Specifications subject to change without prior notice.

# WIRING DIAGRAM

