

TOTO®

CWT4474547CMFGA#MS

RP WASHLET®+ RW Wall-Hung Toilet, 1.28 GPF & 0.9 GPF

FEATURES

RP Bowl

- DYNAMAX TORNADO FLUSH® system, high efficiency (1.28GPF/0.9GPF)
- CEFIONTECT® ceramic glaze minimizes waste from sticking to porous ceramic surfaces
- Universal Height

WASHLET+ RW

- Concealed supply connection for seamless installation
- Gentle aerated, warm water, dual action spray with adjustable pressure and oscillating pulsating features
- Adjustable variable temperature for spray and seat
- Water PREMIST of bowl before each use
- Automatic air deodorizer
- Convenient slim wireless remote, with illuminated touch pad
- EWATER+ auto-cleans wand and bowl
- Warm air drying
- Night light
- Auto Flush
- Auto open/close lid

DuoFit In-Wall Tank

- Dual flushing system, high-efficiency (1.28 GPF/4.8 LPF & 0.9 GPF/3.4 LPF) Avg. flush 1.1 GPF
- Adjustable 15" -19" mounting height
- Saves up to 9" of floor space compared to standard floor-mounted toilet
- Supports up to 880lbs
- Commercial 2" x 6" or optional residential installation with 2" x 4" wall studs with waste outlet kit

COMPONENTS

- CT447CFGT60#01
RP Wall-Hung Toilet
- SW4547AT60#01
WASHLET+ RW
- WT173MA
In-Wall Tank System (1.28 GPF/0.9 GPF)
- YT930#MS
Matte Silver Basic Round Push Plate

Available Options

- YT920#WH - White Matte Basic Square Push Plate
- YT920#MS - Matte Silver Basic Square Push Plate
- YT930#WH - White Matte Basic Round Push Plate
- YT970#SS - Stainless Steel Wall Square Push Plate
- YT980#SS - Stainless Steel Wall Round Push Plate

COLORS/FINISHES

- Standard
#01 Cotton



 **DYNAMAX TORNADO FLUSH**

 **Skirted Design**

 **CEFIONTECT**

 **Universal Height**

 **Auto Flush**

PRODUCT SPECIFICATION

The two-piece high efficiency DYNAMAX TORNADO FLUSH system toilet shall be 1.28 GPF/4.8 LPF and 0.9 GPF/3.4 LPF. Toilet shall have high profile tank, and elongated front bowl. Toilet shall be universal height CST447CFG model shall have CEFIONTECT ceramic glaze. Toilet shall be TOTO Model CST447CFG _____.

CODES/STANDARDS

- Meets and exceeds ASME A112.19.2/CSA B45.1
- Certifications: IAPMO (cUPC), EPA WaterSense, State of Massachusetts, City of Los Angeles, and others
- Code Compliance: UPC, IPC, NSPC, NPC Canada, and others
- Legislative Compliance: California AB715, California Green Building Code, City of Los Angeles Water Efficiency Ordinance
- ADA compliant



CWT4474547CMFGA#MS

RP WASHLET®+ RW Wall-Hung Toilet, 1.28 GPF & 0.9 GPF

SPECIFICATIONS & INSTALLATION NOTES

	SW4547AT60
Power Rating	AC 120V-60Hz, 406W
Power Cord	2.95 ft/120 cm Length 3 Prong Grounded Plug
Water Feature (Flow Rates)	Rear: 9.1-14.5 oz/min
	Front: 9.8-14.5 oz/min
	Soft Rear: 9.1-14.5 oz min
Washing Spray Temp.	Min: 86°F/30°C Max: 104°F/40°C
Safety Device	Thermal Fuse
Air Dryer Temp.	Min: About 95°F/35°C Max: About 140°F/60°C
Dryer Air Capacity	10.24 ft³/min
Seat Warming Temp.	Min: 82°F/28°C Max: 97°F/36°C
Water Supply Pressure	Min: 7.25 psi Max: 108.75 psi
Ambient Temp.	Min: 32°F/0°C Max: 104°F/40°C
Warranty	One Year Limited Warranty
Shipping Weight	16 lbs.
Shipping Dimensions	26" L x 17-11/16" W x 7-3/16" H

	CT447CFG60	WT173MA
Water Use	1.28 GPF & 0.9 GPF (4.8 LPF & 3.4 LPF)	1.28 GPF & 0.9 GPF (4.8 LPF & 3.4 LPF)
Flush System	DYNAMAX TORNADO FLUSH®	Dual-Max®
Min. Water Pressure	8 psi (static)	8 psi (static)
Water Surface	5-1/2" X 4-1/8"	
Trap Diameter	2-1/8"	
Installation Height	15" to 19"	15" to 19"
Trap Seal	2-1/8"	
Warranty	One Year Limited Warranty	One Year Limited Warranty
Material	Vitreous China	Various
Shipping Weight	76 lbs.	43 lbs
Shipping Dimensions	16" L x 14"W x 24" H	47-1/2" x 26" x 6"

RW WASHLET

- WASHLET RW may not fit certain toilet bowl designs
- If possible, with your order, please include your model number (from the underside of the tank lid)
- It is highly recommended to use a surge protector to prevent damage in the event of a power surge

DuoFit In-Wall Tank

- Adequate structural bracing is required

DIMENSIONS

CT447CFG60

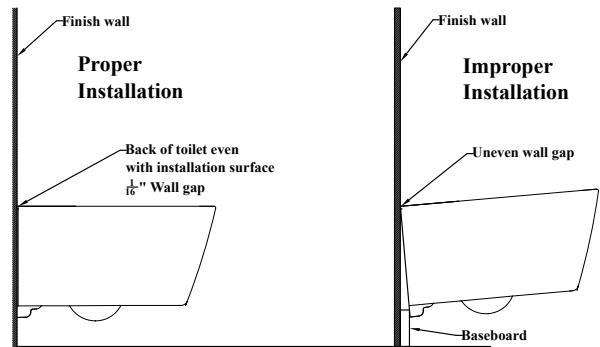
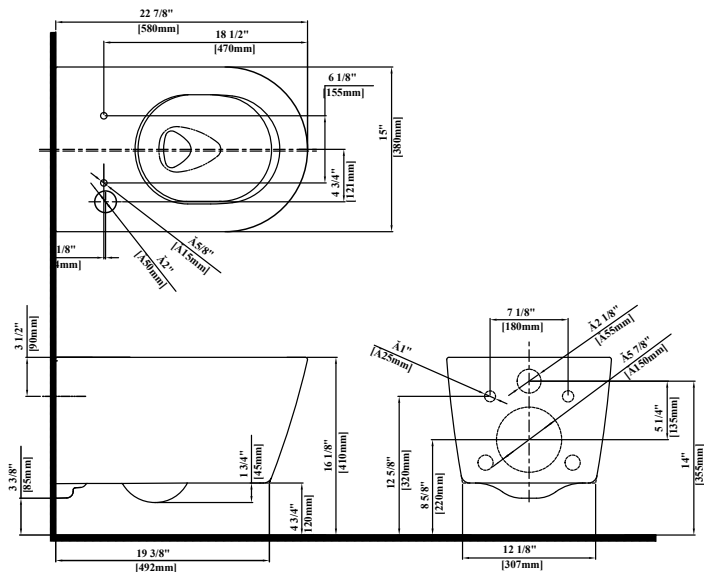

CWT4474547CMFGA#MS

RP WASHLET®+ RW Wall-Hung Toilet, 1.28 GPF & 0.9 GPF

DIMENSIONS

YT930

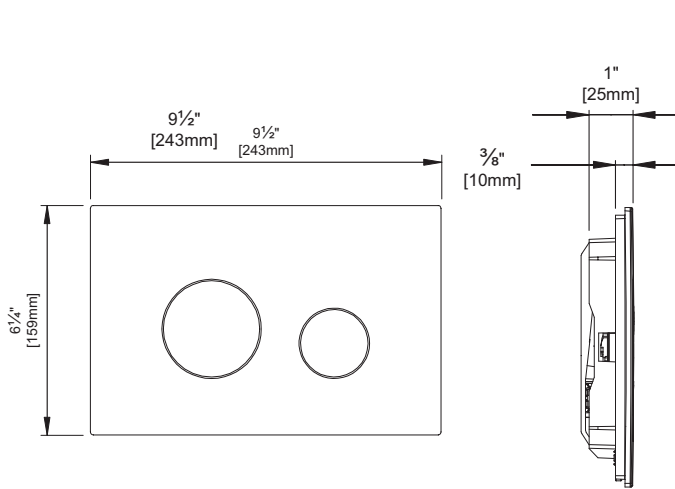

SW4547AT60

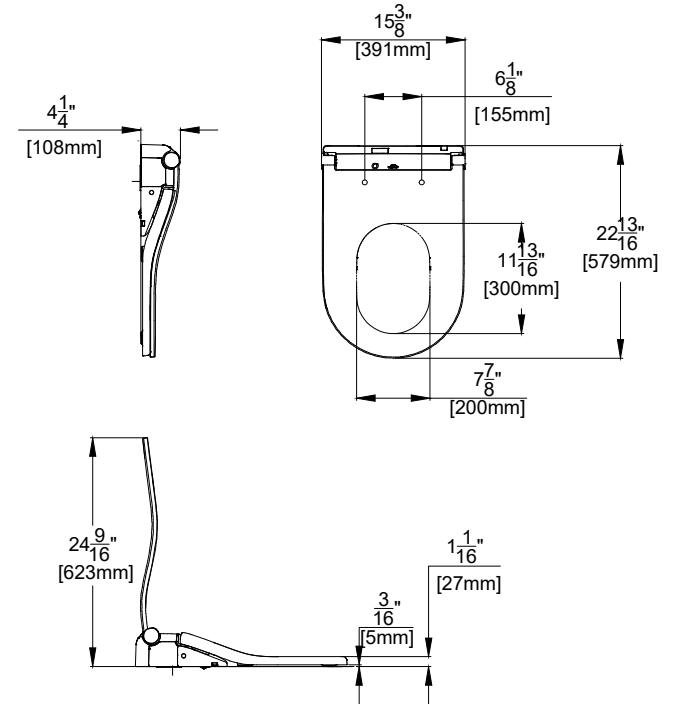

WT173MA

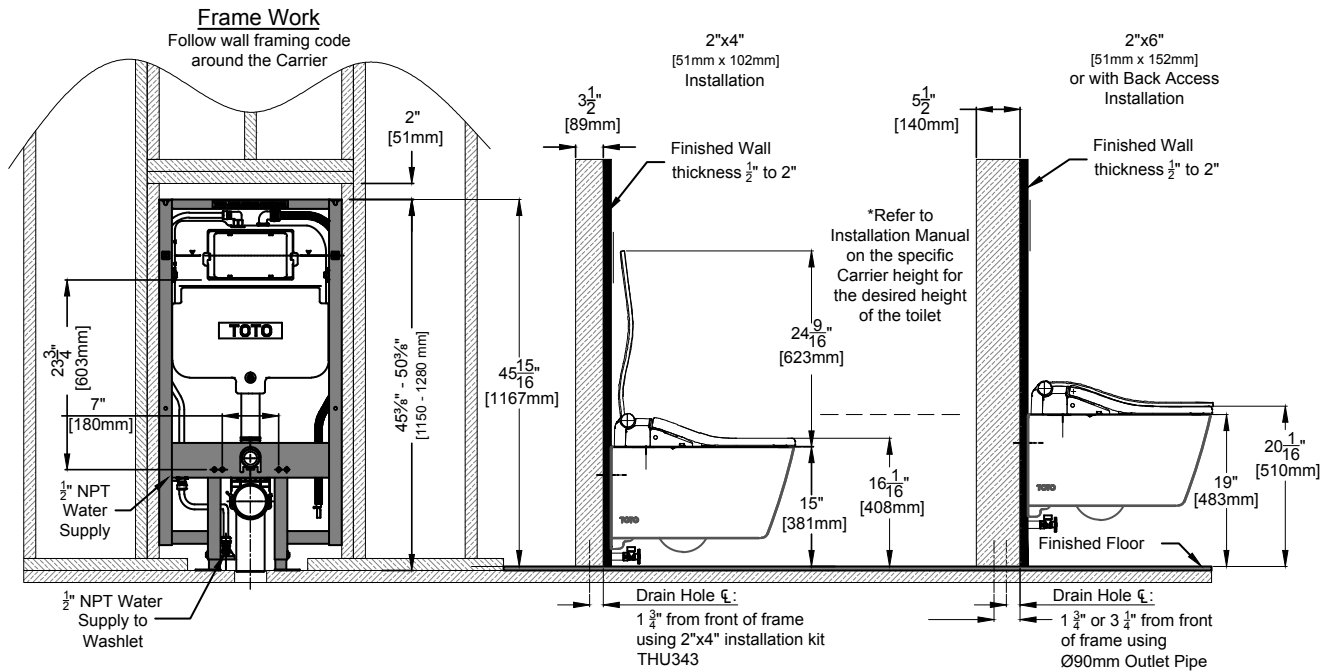

TOTO

These dimensions and specifications are subject to change without notice