

Marshall

Broadcast A/V Division

CV620-BI, CV620-WI CV620-BN, CV620-WN

20x PTZ IP/NDI Camera







User Manual

Table of Contents

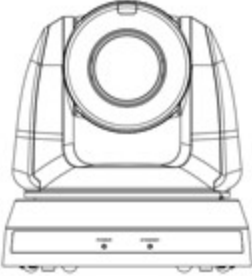
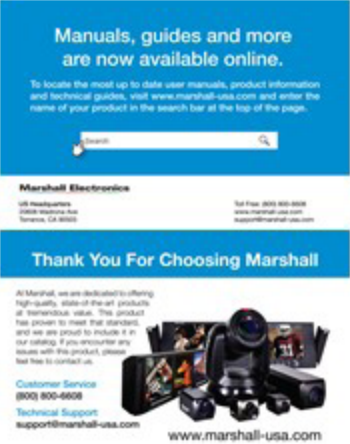
- Chapter 1 Package Contents 3**
- Chapter 2 Function Introduction 4**
 - 2.1 I/O functions Introduction 4
 - 2.2 Description of LED indicator 5
- Chapter 3 Instruction for installation 6**
 - 3.1 Preparation before installation 6
 - 3.2 Instruction for installation 6
 - 3.3 Connecting devices 12
- Chapter 4 Remote Control and Setting Menu 15**
 - 4.1 Functions of remote control 15
 - 4.2 Setting Menu 16
- Chapter 5 Network Function Settings Description 20**
 - 5.1 Connecting Camera to Network 20
 - 5.2 Web Page Function Description 23
- Chapter 6 DIP Switch Setting 37**
 - 6.1 OUTPUT Switch 37
 - 6.2 IR SELECT 37
 - 6.3 Camera Address Selector 37
 - 6.4 System Switch 37
- Chapter 7 Troubleshooting 38**
- Chapter 8 Safety Instructions 39**
- Supplier’s Declaration of Conformity 47 CFR § 2.1077
Compliance Information 40**

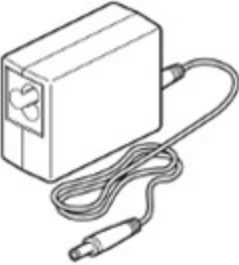
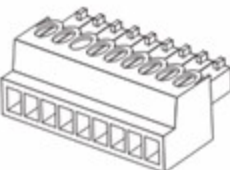
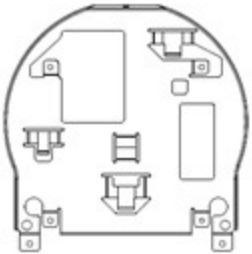
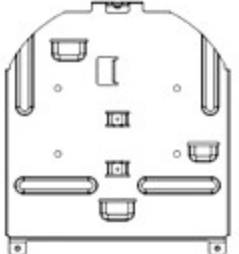
Chapter 1 Package Contents

Camera	Marshall Card	Remote Control
		
3 x Power Cords	Power Adapter	RS-422 Connector
 Appearance may vary depending on country/region		
Metal Plate A	Metal Plate B	M3 Screws
		 Silver x 8 / Black x 2

Chapter 2 Function Introduction

2.1 I/O functions Introduction

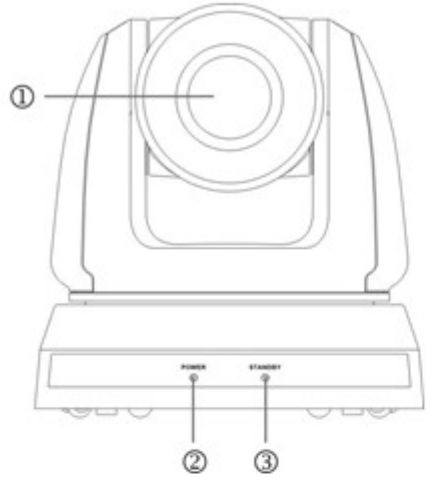

Item	Function Descriptions
1. Camera Lens	HD camera lens, sensor and zoomblock
2. Power LED	Camera power indicator, please refer to section 2.2 Description of LED indicator
3. Standby LED	Camera status indicator, please refer to section 2.2 Description of LED indicator

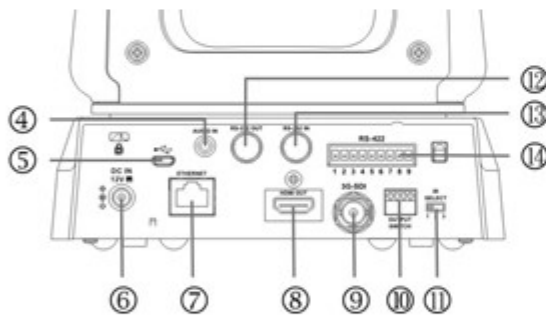

Item	Function Descriptions
4. Audio in	3.5mm Line/Mic level input
5. Micro USB port	Firmware updates via USB port
6. Power input	AC power supply connecting port
7. Ethernet (IP) port	Supports IEEE 802.3at PoE + power supply
8. HDMI output	HDMI output (audio embedded option)
9. 3G-SDI output	3G/HD-SDI output
10. OUTPUT Switch	Adjusts Resolution/Framerate on power-cycle. The default is 1920x1080p60fps
11. IR SELECT	IR Remote control ID setting corresponds with ID select button on IR remote. It can be controlled only when it corresponds to the Camera Select on the remote control.
12. RS-232 output	RS-232 loop out port, up to 7 cameras can be connected in a daisy chain serial setup
13. RS-232 input	RS-232 input port, up to 7 cameras can be connected in a serial connection
14. RS-422 port	RS-422 connecting port, up to 7 cameras can be connected in RS422 serial connection

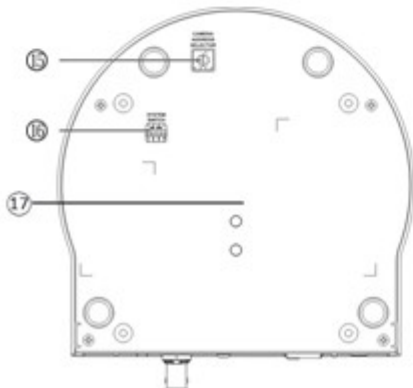

Item	Function Descriptions
15. Camera Address Selectors	Camera ID Setting for RS232 and RS422
16. SYSTEM Switch	System DIP Switch Setting
17. Tripod lock hole	Camera mount on a 1/4" - 20 UNC tripod to lock into place and prevent rotation.

2.2 Description of LED indicator

Status	Power	Standby
Startup in progress	Green light	Orange light
In use	Green light	No indicator
In standby mode	No indicator	Orange light
Tally mode	Red light	Red light

The Tally LED mode can be enabled via RS-232 command control. Please download the RS232 Command Set from the Marshall website or reach out to support.mei@marshall-usa.com

Chapter 3 Instruction for installation

3.1 Preparation before installation

Installation and connection of this PTZ camera requires some skill. To install by yourself, please follow necessary steps to ensure a safe and secure installation of this device.

- Prepare installation environment or fixed mount structure. Please do not install the device on unstable fixtures or anywhere the camera would be in danger of falling or be introduced to environmental moisture, dust or dirt.
- Please check accessories in the box to be sure its complete. Please contact the supplier for any shortages, and make sure to keep the accessories and not throw them away with box.
- Please choose a secure place for installation of camera in advance. Please determine an installation spot based on these variables.

1. Consider the position of the camera to the areas of interest or capture targets.
2. Consider the position of the camera to light sources, as they can affect performance.

3.2 Instruction for Installation

3.2.1 Desktop Installation.

3.2.1.1 Precautions for installation

- Please install the machine on a flat desk
- Do not handle or carry the camera by the camera head.
- Do not rotate the camera head by hand. Improper rotation may result in breakdown of the camera belts and gears.

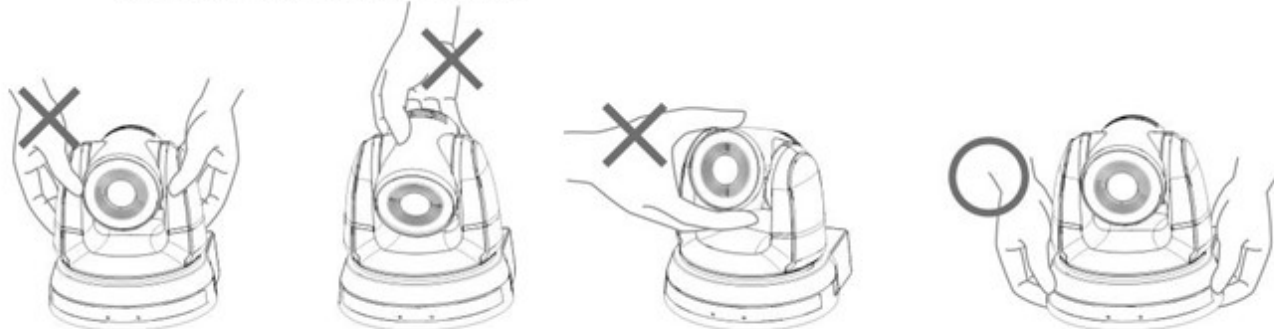

3.2.1.2 Installation steps

1. Please adjust DIP switches before installation and operation.
 - Please refer to [Chapter 6 DIP Switch Setting](#) for the relevant descriptions on DIP switch.
2. Place the camera on a flat desk directly to ensure the normal vertical and horizontal operation of the machine

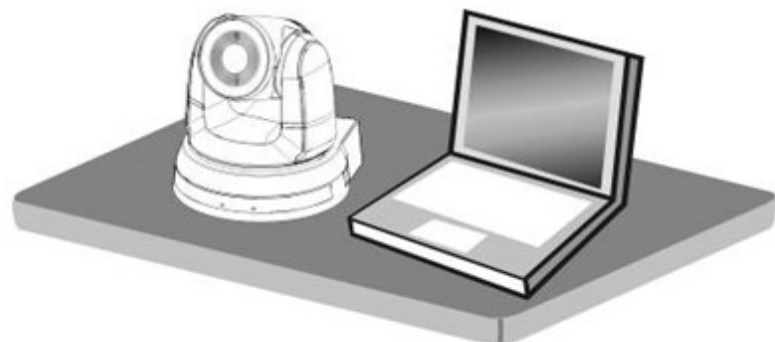

3.2.2 Ceiling Mount Installation

3.2.2.1 Prepare for the parts and equipment required during the installation

- Accessories in the box (metal plates A, B, M3 screw silver x 8, black x 2)
- Screw for locking on ceiling mounted hanger x 4
- Drilling machine, screwdriver, ladder

3.2.2.2 Camera Size

- L x W x H: 174 x 187 x 186 mm
- Weight: 2.0 Kg

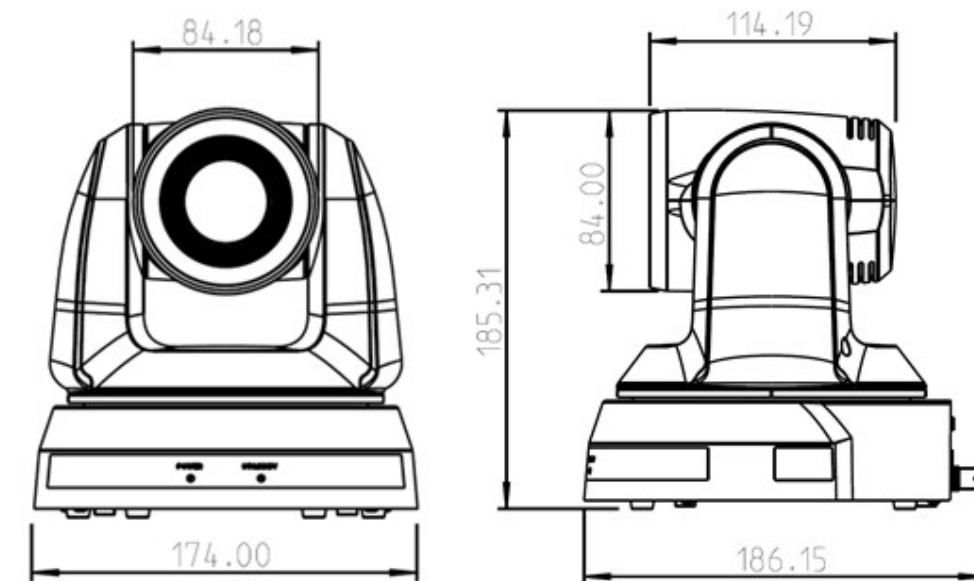

3.2.2.3 Dimensions of the bottom of the machine

The camera can be mounted on a 1/4", -20 UNC PTZ tripod deck by using the lock

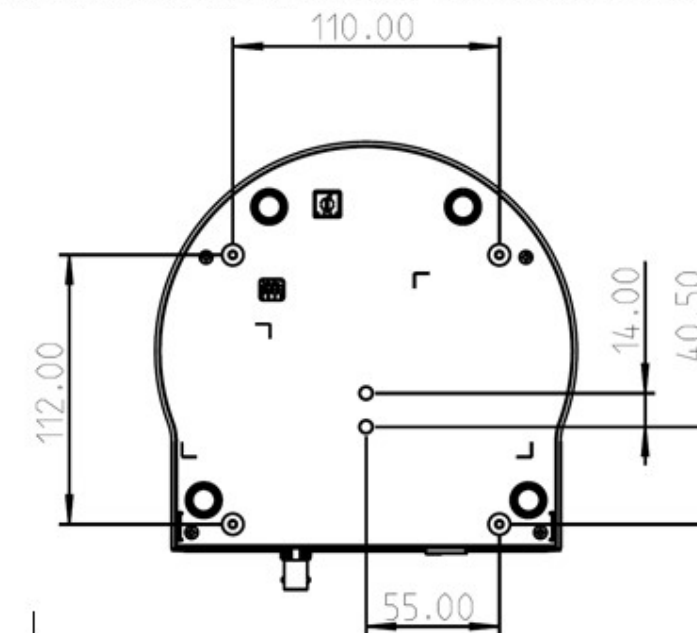

3.2.2.4 Metal Plate size diagram

■ Metal plate A - machine side

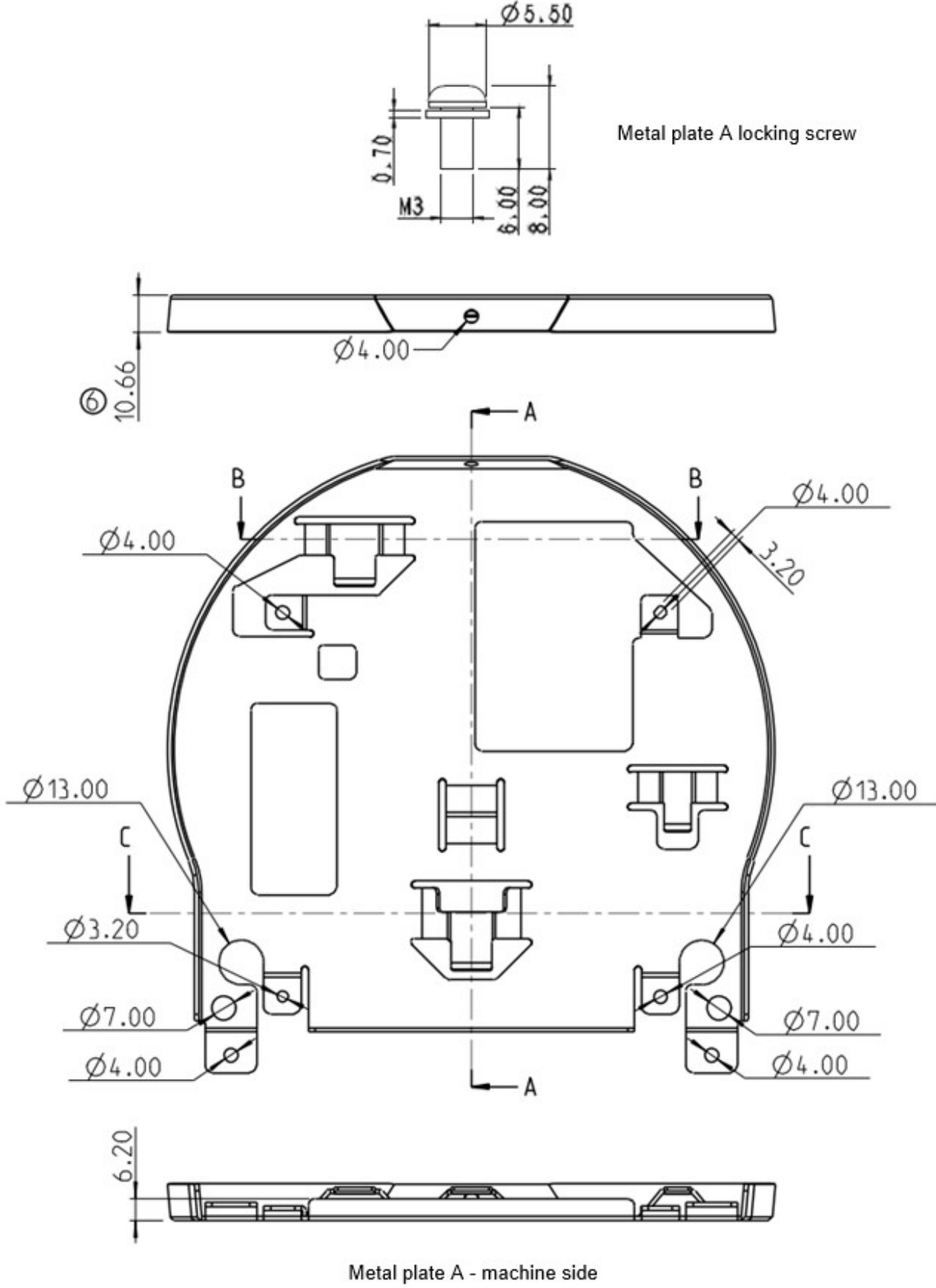

■ Metal plate B - ceiling side

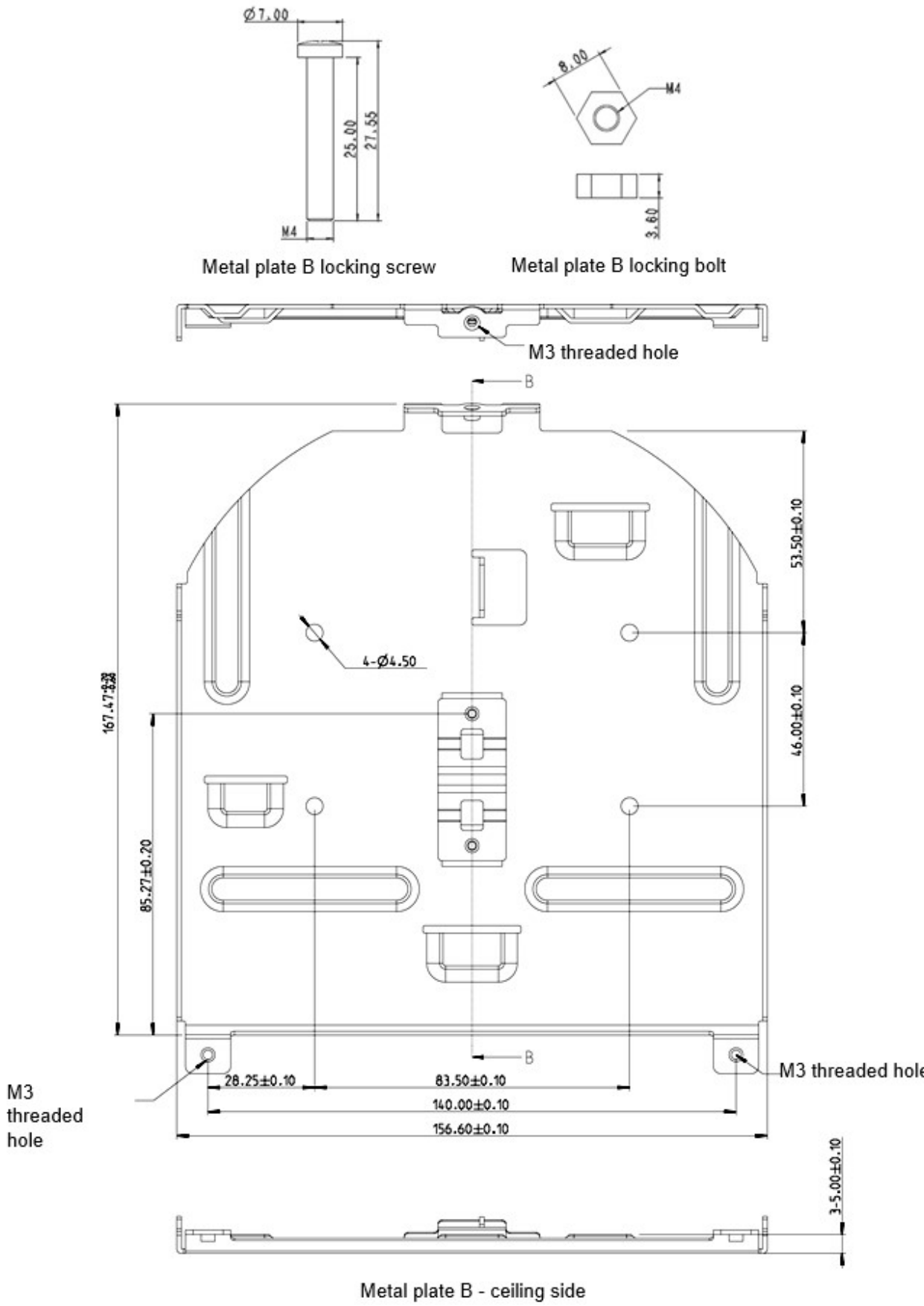

3.2.2.5 Precautions for installation

- Before installation, please confirm the orientation of the machine relative to the object or people to be captured, analyze the field-of-view from camera position.
- It is recommended that the machine should be set at more than 1.5 meters (MOD) away from the object to be captured. Please adjust for a best distance in relation to the magnification of the lens.

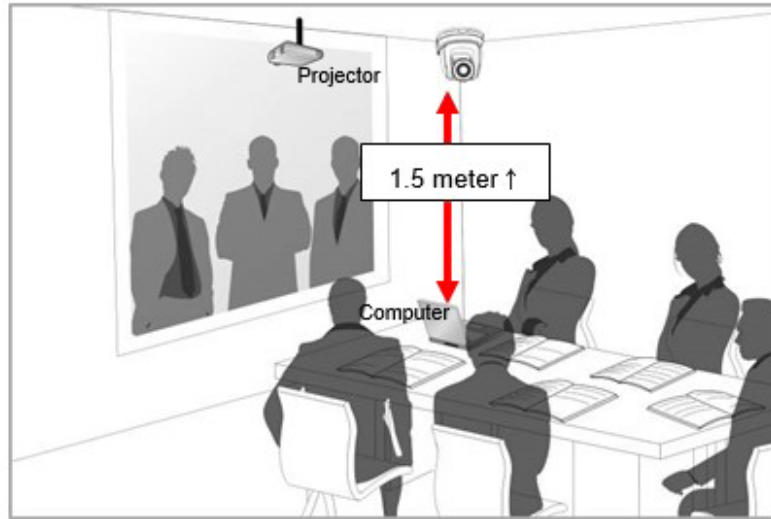

- The machine (including metal plates) is roughly 2.5 kg. If it is to be installed on the ceiling, please use the hanger that has obtained UL security approval to prevent the machine from coming loose and falling.
- Please check mounts on a regular basis to ensure they're secure and stay secure.

3.2.2.6 Installation steps

- Please adjust resolution on DIP switch before powering on the camera.
- ✘ Please refer to [Chapter 6 DIP Switch Setting](#) for the relevant descriptions on DIP switch
- Fix the metal plate A on the machine base with 4 M3 silver screws

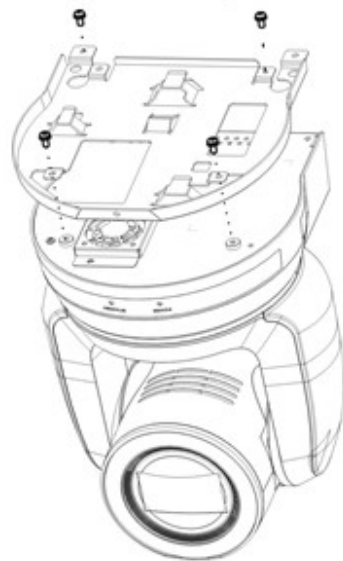

- Lock the metal plate B on ceiling mounted hanger

<Note>

- Please use the hanger that has obtained UL security approval
- Please reserve the hole for the connecting wires of the camera

- Combine the metal plate A and the metal plate B

- Push the metal plate A up to the ceiling and then to the right to latch the metal plate B
- And then secure with 2 M3 silver screws and 1 M3 black screw

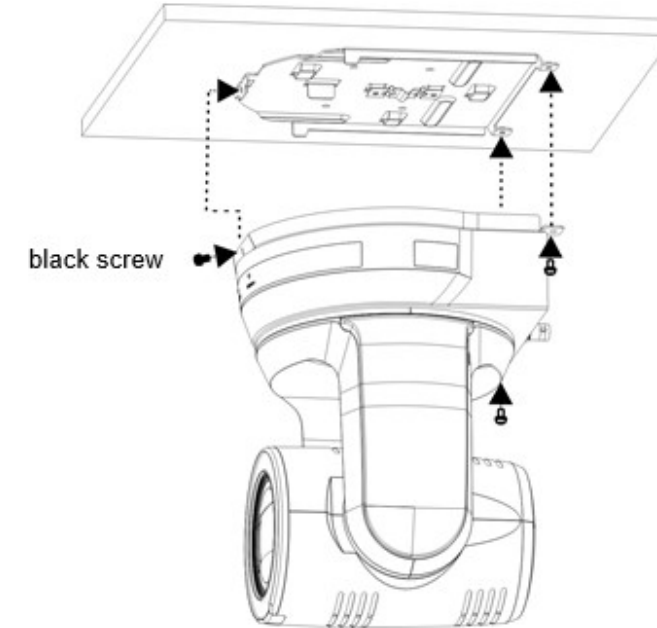

3.2.2.7 How to remove

- Remove the connecting wires from the camera
- Uninstall the camera together with the ceiling, loosen the three screws that fix the metal plates A and B and push to the left or forward to remove the camera

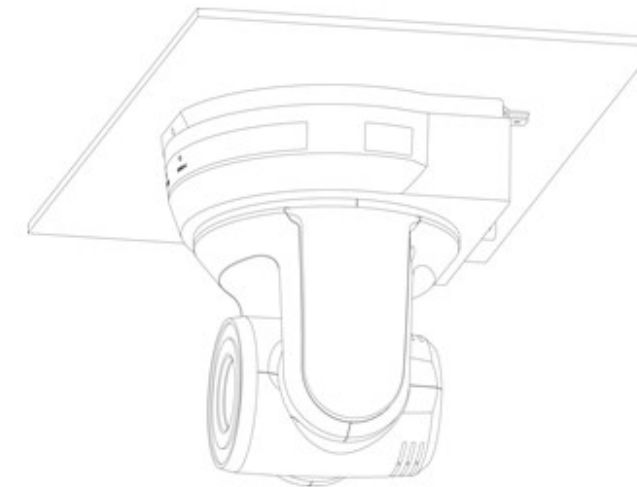

- Then remove the screws on the hanger and the machine

3.3 Connecting devices

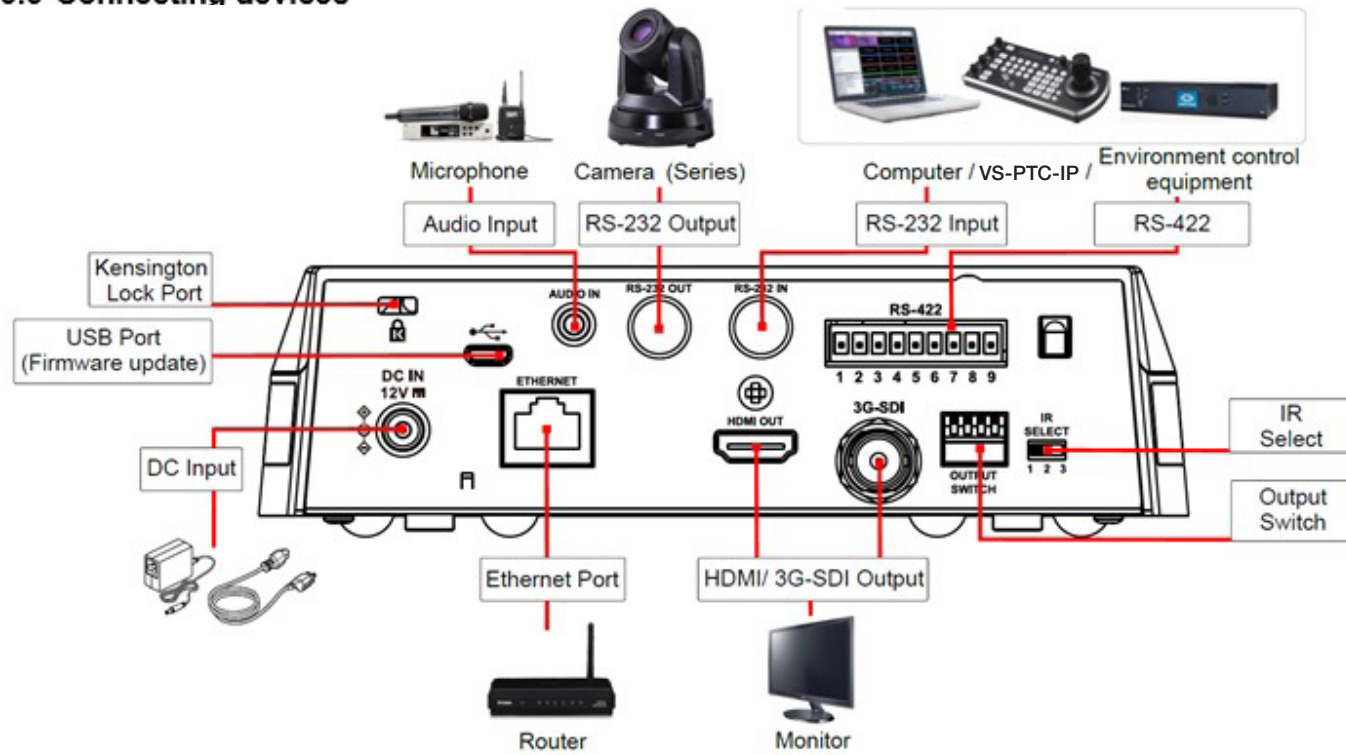

3.3.2 RS-422 connection (up to 7 Marshall cameras can be connected)

※ Only one of RS-422/RS-232 can be selected for control, please refer to [6.4 System Switch](#), DIP1 setting

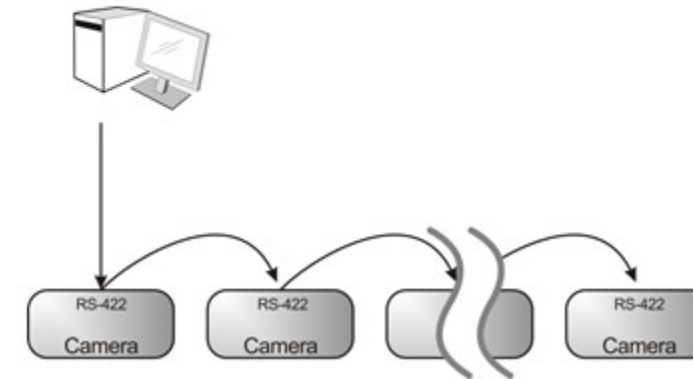

■ RS-422 pins definition instructions

▼ RS-422 Pins Instructions

Pin NO.	Function
1	RXD OUT-
2	RXD OUT+
3	TXD OUT-
4	TXD OUT+
5	GND
6	RXD IN-
7	RXD IN+
8	TXD IN-
9	TXD IN+

▼ RS-422 Serial Connection

Up to seven cameras can be daisy-chained

3.3.1 RS-232 connection (up to 7 Marshall cameras can be connected)

※ Only one of RS-422/RS-232 can be selected for control, please refer to [6.4 System Switch](#), DIP1 setting

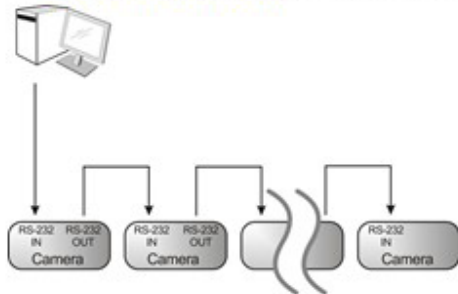

■ RS-232 pins definition instructions

▼ RS-232 IN Pins Instructions

NO	Pins	Signals
1	DTR	Data Transmission Reade
2	DSR	Data Set Reade
3	TXD	Transmit Data
4	GND	Ground
5	RXD	Receive Data
6	GND	Ground
7	IR OUT	IR Commander Signal
8	N.C.	No Connection

▼ RS-232 OUT Pins Instructions

NO	Pins	Signals
1	DTR	Data Transmission Reade
2	DSR	Data Set Reade
3	TXD	Transmit Data
4	GND	Ground
5	RXD	Receive Data
6	GND	Ground
7	OPEN	Reserved
8	OPEN	Reserved

▼ RS-232 Connection Instructions

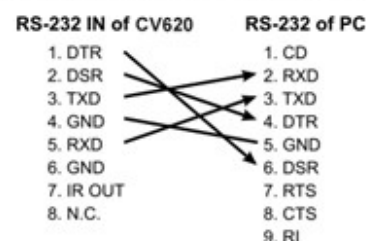

▼ RS-232 Connection Instructions

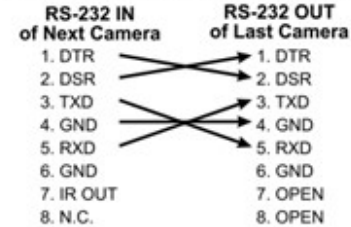

▼ RS-422 Connection Instructions

—Applicable to VS-PTC-200 Camera Controller

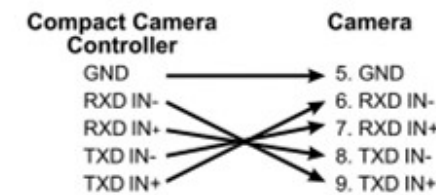

▼ RS-422 Connection Instructions

—Applicable to SONY Compact Camera Controller

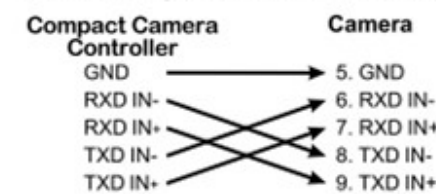

Compact Camera Controller

1	NC
2	NC
3	NC
4	NC
5	GND
6	RXD IN-
7	RXD IN+
8	TXD IN-
9	TXD IN+

Third Camera

1	RXD OUT-
2	RXD OUT+
3	TXD OUT-
4	TXD OUT+
5	GND
6	RXD IN-
7	RXD IN+
8	TXD IN-
9	TXD IN+

Second Camera

1	RXD OUT-
2	RXD OUT+
3	TXD OUT-
4	TXD OUT+
5	GND
6	RXD IN-
7	RXD IN+
8	TXD IN-
9	TXD IN+

First Camera

1	RXD OUT-
2	RXD OUT+
3	TXD OUT-
4	TXD OUT+
5	GND
6	RXD IN-
7	RXD IN+
8	TXD IN-
9	TXD IN+

■ RS-422 connection instructions

1. Hold the two sides of RS-422 connector and pull out in the direction shown by the arrow in the figure below

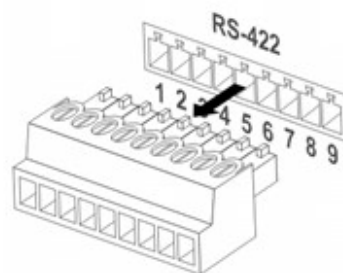

2. Splice copper wire (AWG Nos. 28 to 18) and insert it into the connector hole; then use flat screwdriver to fix it

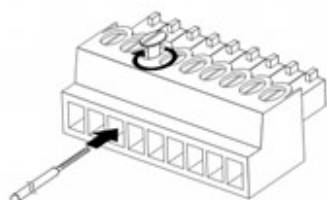

3. Insert the wired RS-422 connector back to the camera. Now the connection is completed

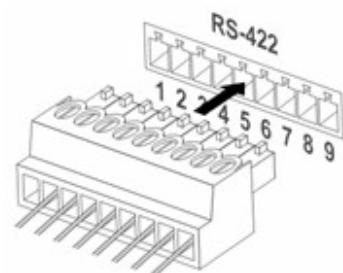

Chapter 4 Remote Control and Setting Menu

4.1 Functions of remote control

- The below functions are listed alphabetically



Item	Remark
◀, ▶, ▲, ▼	Move the camera head
Back Light	Turn on/off back light compensation
Camera select	Choose camera ID 1 ~ 3
Focus-Manual / Far/Near	Turn on manual focus to adjust the focal length
Focus-Auto	Auto Focus
Freeze	Freeze the screen
Home-Enter	Go back to the main page or EXECUTE
Info	Status information
L/R Direction Set	Left/Right Direction / Normal
Menu	Display OSD menu
Mirror	Rotate the image (OFF/Mirror/Flip/Rotate)
Pan/Tilt Reset	Clear the Pan/Tilt setting
Picture	Switch image effect (OFF / Neg / B&W)
Power	Power Button Switch
Preset	Appoint an ID (0 ~ 9) to save the current position data
Reset	Appoint an ID (0 ~ 9) to delete the saved position data
Zoom-Fast	Adjust image zoom
Zoom-Slow	Fine-tune image zoom

4.2 Setting Menu

※ Press **[MENU]** on the **remote control** to enter the setting menu; the **bold underlined** values in the following table are defaults.

1st Level Major Items	2nd Level Minor Items	3rd Level Adjustment Values	Function Descriptions	
Exposure	Mode	<u>Automatic</u> /Shutter Priority/Aperture Priority/Manual	Exposure mode setting	
	Exposure Comp.	On / <u>Off</u>	AE Level	
	Exposure Comp. Level	-6~ <u>C</u> ~5	The value can be adjusted after <i>Exposure Comp.</i> is activated	
	Shutter Pri	60/30 mode	50/25 mode	Adjustable when the <i>Exposure mode</i> is set to <i>Shutter Pri</i>
		1/10000~1/1		
	Iris Pri	<u>F1.6</u> ~F6.3	Adjustable when the <i>Exposure mode</i> is set to <i>Iris Pri</i>	
	Manual Gain	0~45dB	Adjustable when the <i>Exposure mode</i> is set to <i>Manual</i>	
	Manual Speed	60/30 mode	50/25 mode	Manually set the shutter
		1/10000~1/1		
	Manual Iris	<u>F1.6</u> ~F6.3	Manually set the iris	
	Gain Limit	9~ <u>C</u> ~45dB	Max. limit value of electron gain	
	Iris Limit	F1.6~ <u>C</u> ~F6.3	Max. limit value of iris	
	WDR	<u>Off</u> / 1 / 2 / 3 / 4 / 5		
White Balance	Mode	1. <u>Auto</u>	Select the color temperature mode 1. 4000k ~ 7000k 2. 3200k 3. 5800k 4. 1700k ~ 10000k 5. 1700k ~ 10000k 6. Custom 7. 2800k	
		2. Indoor		
		3. Outdoor		
		4. One Push WB		
		5. ATW		
6. Manual				
7. Sodium Lamp				
8. 3000K				
9. 4300K				
10. 5000K				
11. 6500K				
12. 8000K				
13. Wide Auto				
One Push Trigger	<u>ENTER</u>	One push trigger		
Manual Red	0~ <u>C</u> ~128	Adjustable when the white balance mode is set to <i>Manual</i>		
Manual Blue	0~ <u>C</u> ~128	Adjustable when the white balance mode is set to <i>Manual</i>		

1st Level Major Items	2nd Level Minor Items	3rd Level Adjustment Values	Function Descriptions
Picture	Picture effect	<u>OFF</u> / Neg / B&W	
	Sharpness	0~ <u>C</u> ~15	
	2D NR	<u>AUTO</u> / OFF / 1 / 2 / 3 / 4 / 5	
	3D NR	Off / Low / <u>Standard</u> / Highest / Auto	
	Image Mode	Mode 1 ~ 6/Self-defined	The user may customize his/her desired image mode
	Image Mode Load	<u>ENTER</u>	Adjustable when the <i>Image mode</i> is set to <i>Custom</i> . After selected, the corresponding <i>Image mode</i> parameters will be read and applied to <i>Custom</i>
	Brightness	0~ <u>C</u> ~25	Adjustable when the <i>Image mode</i> is set to <i>Custom</i>
	Contrast	0~ <u>C</u> ~25	Adjustable when the <i>Image mode</i> is set to <i>Custom</i>
	Saturation	0~ <u>C</u> ~25	Adjustable when the <i>Image mode</i> is set to <i>Custom</i>
	Black Level	Type 1 ~ 5 / <u>Off</u>	Adjustable when the <i>Image mode</i> is set to <i>Custom</i>
	Gamma	0~ <u>C</u> ~3	Adjustable when the <i>Image mode</i> is set to <i>Custom</i>
	Skin Tone	0~ <u>C</u> ~5	
	Pan Tilt Zoom	Pan/Tilt Limit	On / <u>Off</u>
Pan Right Limit		0~ <u>170</u>	Limit the right angle
Pan Left Limit		<u>-170</u> ~0	Limit the left angle
Tilt UP Limit		0~ <u>90</u>	Limit the upward angle
Tilt Down Limit		<u>-30</u> ~0	Limit the downward angle
Pan Flip		On / <u>Off</u>	Activate the reverse Pan command
Tilt Flip		On / <u>Off</u>	Activate the reverse Tilt command
Preset Speed		5 ~ 300 deg/sec	Set the rotation speed of the cradle head when Preset is executed
PTZ Speed Comp		On / <u>Off</u>	Set the Pan/Tilt moving speed to vary from the zoom position
Zoom Limit		<u>x1</u> ~x20	Set the zoom ratio limit
D-Effect	Mirror	<u>OFF</u> / Mirror / Flip / Mirror + Flip	Set the mode at which the image is turned
Auto Focus	AF Sensitivity	Low / <u>Mid</u> / High	For AF triggering speed, the higher the speed is, the faster AF is triggered

1st Level Major Items	2nd Level Minor Items	3rd Level Adjustment Values	Function Descriptions
	AF Frame	Center Area / <u>All Area</u>	AF frame setting, when central area was set as AF frame, focusing will be on the center of the screen. When Full Frame was set as AF frame, focusing will be calculated based on the full screen
	PTZ Assist	On / <u>Off</u>	Turn on the auto focus function in Manual
Ethernet	DHCP	<u>On</u> / Off	Enable/Disable DHCP setting using left and right arrow keys and press [ENTER] to apply setting.
	IP Address	<u>192.168.100.150</u>	Press [ENTER] to be in modify mode; select the item to be modified using the up and down keys and modify the value using the left and right keys or the numeric keys.
	Subnet mask	<u>255.255.255.0</u>	
	Gateway	<u>192.168.100.254</u>	
Audio In	<u>Line In</u> / Mic In	Set Audio In	
Audio	Audio Enable	On / <u>Off</u>	Turn on/off audio output
	Audio Volume	0~ <u>C</u> ~10	Volume Setting
	Audio Delay	On / <u>Off</u>	When audio and video are out of sync, enable this feature to set the audio delay time
	Audio Delay Time (ms)	<u>1</u> ~500ms	Set audio delay time
	Encode Sample Rate	1. <u>48 KHz (AAC)</u> 2. 44.1 KHz (AAC) 3. 16 KHz (AAC) 4. 16 KHz (G.711) 5. 8 KHz (G.711)	Set the encode type and sample rate SDI only supports 48 KHz audio embedding output
	Prompt	On / <u>Off</u>	Turn on/off the prompt information on the display
System	IR Receive	<u>On</u> / Off	
	Tally Lamp	<u>On</u> / Off	Select Off and it will not be triggered by commands to turn on or off
	Language	<u>English</u> / Chinese	
	Initial Position	<u>Last MEM</u> / 1st Preset	Select the camera lens to return to the last operated position or the first preset position after POWER ON ※First default position = Preset 0

1st Level Major Items	2nd Level Minor Items	3rd Level Adjustment Values	Function Descriptions
	Control Device	Encoder / <u>Controller</u>	Control Device setting, Controller: for joystick Encoder: for tracking system
	Motionless Preset	On / <u>Off</u>	When the function is enabled, the screen will Freeze when Preset is executed. Freeze will be released after Preset is completed.
	Protocol	<u>VISCA</u> / Pelco D	Command Types
	Pelco D Address	<u>1</u> ~255	The Protocol set to Pelco D allows the camera ID address to be assigned
	Output Mode	1080p 60/59.94/50/30/29.97/25 1080i 60/59.94/50 720p 60/59.94/50	Choose the output resolution
	Factory Reset	On / <u>Off</u>	Resume the factory default setting
	FW Upgrade	On / <u>Off</u>	
Status			Display the current setting status

Chapter 5 Network Function Settings Description

5.1 Connecting Camera to Network

5.1.1 Connecting to Internet

Two common connection methods are shown below:

1. Connecting via switch or router

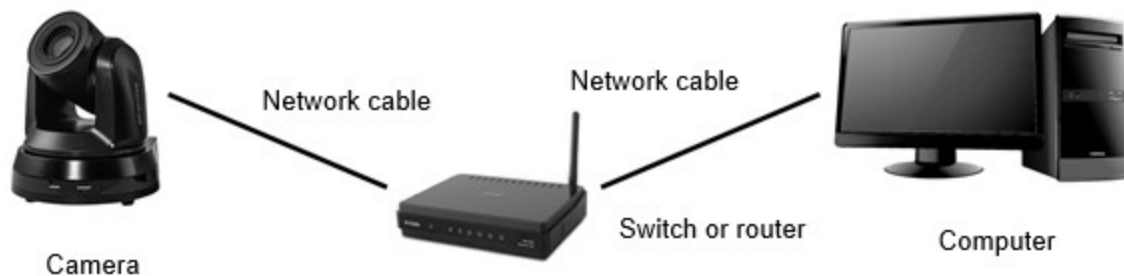

- To connect directly through network cable, the IP address of the computer should be changed so that it is on the same network segment as the camera
E.g.: The factory-preset default IP address of the camera is 192.168.100.150. The computer IP address must be set with the same network segment, such as 192.168.100.101, so that the computer can be connected correctly with the camera

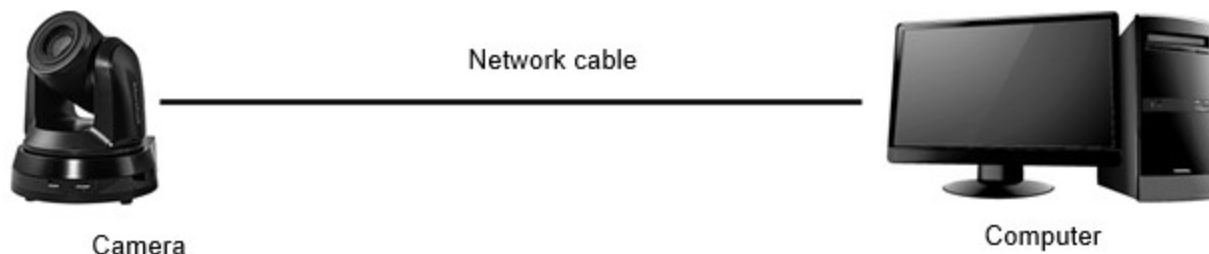

- Change network settings

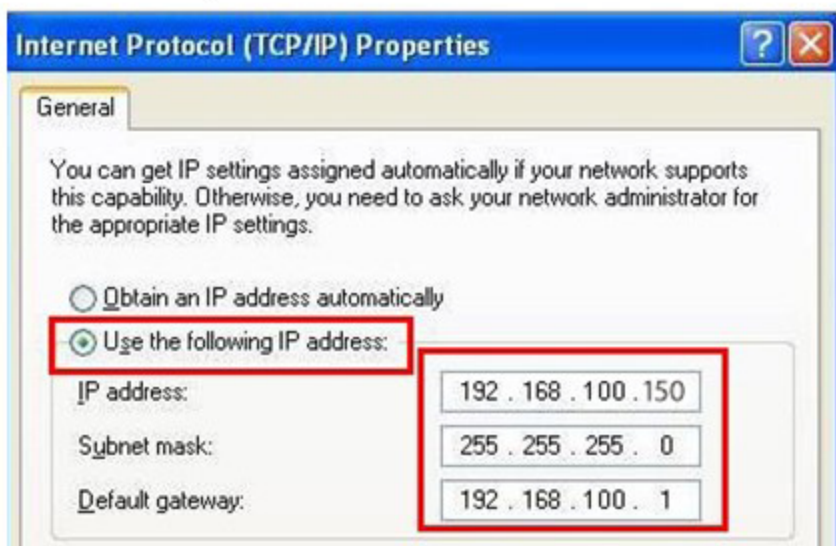

5.1.2 Using the Browser to View the Images

- Open the browser, and enter the URL of camera in the IP address bar
E.g.: <http://192.168.100.150> (default IP address)
- Enter administrator's account and password
*When log in for the first time, please refer to [5.2.3 Account Management](#) to change the default password.

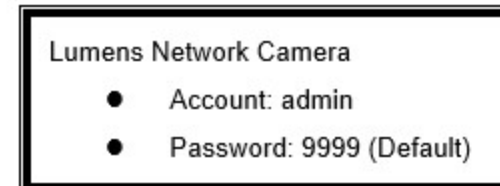
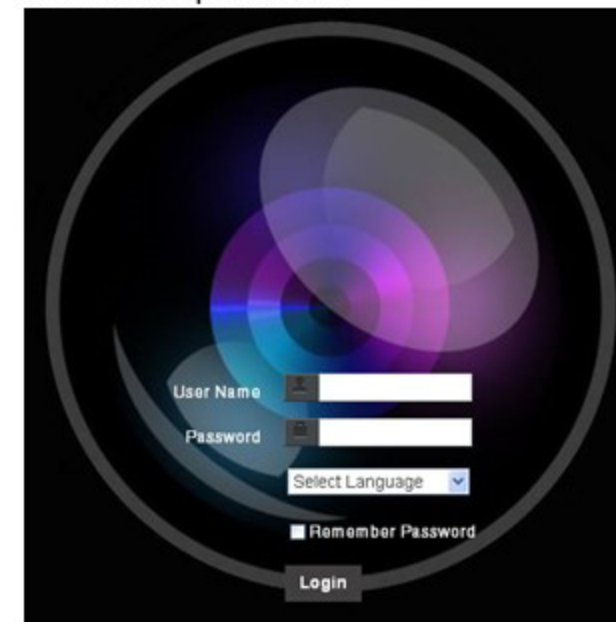

5.1.3 Using Marshall VMS Software to View the Images

For CV620-BN/WN, turn off NDI|HX to support preview screen (Please refer to [5.2.4 Setting - Video - NDI|HX](#))

- Open **Marshall VMS** software (Please download from the Marshall official website)
- Search Camera: Press [automatically search for the device] button to locate the Camera
- Click the camera in the list and start operation after connecting to network
- ✗ **When using automatic search, the camera and computer must be in the same network segment, e.g.: 192.168.4.X**

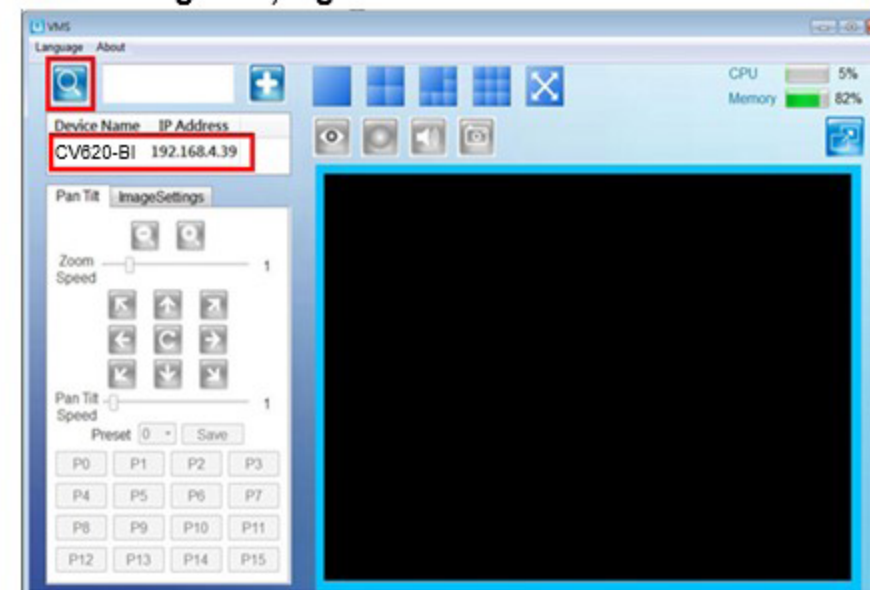

5.1.4 Using RTSP Player to View the Images

For CV620-BN/WN, turn off NDI|HX to support preview screen (Please refer to [5.2.4 Setting - Video -NDI|HX](#))

In addition to the browser and VMS, other free software also can be used for RTSP connection, such as VLC, Quick Time and PotPlayer

RTSP connection address formats are as follows:

- RTSP mainstream (h.264) =><rtsp://Cam IP Address:8557/h264>
- RTSP second stream (h.264) =><rtsp://Cam IP Address:8556/h264>
- RTSP second stream (MJPEG) or single stream in MJPEG=><rtsp://Cam IP Address:8555/mjpeg>

If password authentication is enabled, the RTSP connection address is as follows:

- <rtsp://Username:Password@Cam IP address: port/hevc>
- <rtsp://Username:Password@Cam IP address: port/mjpeg>

<Remark> To enable password authentication function, please refer to [5.2.9 Setting - Network](#)

Example:

Open VLC software, click [Open Network Streaming], and enter a URL:

<rtsp://192.168.100.150:8557/h264>

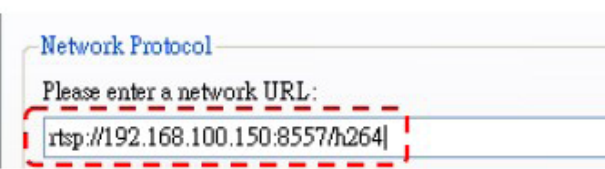
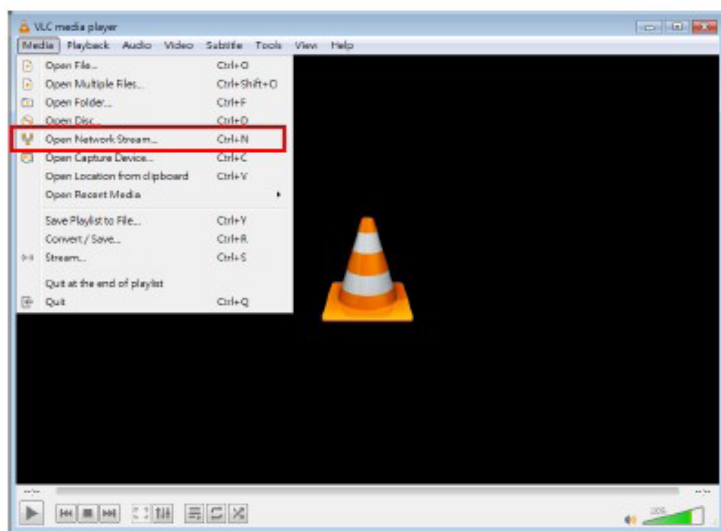

5.2 Web Page Function Description

5.2.1 Login Screen

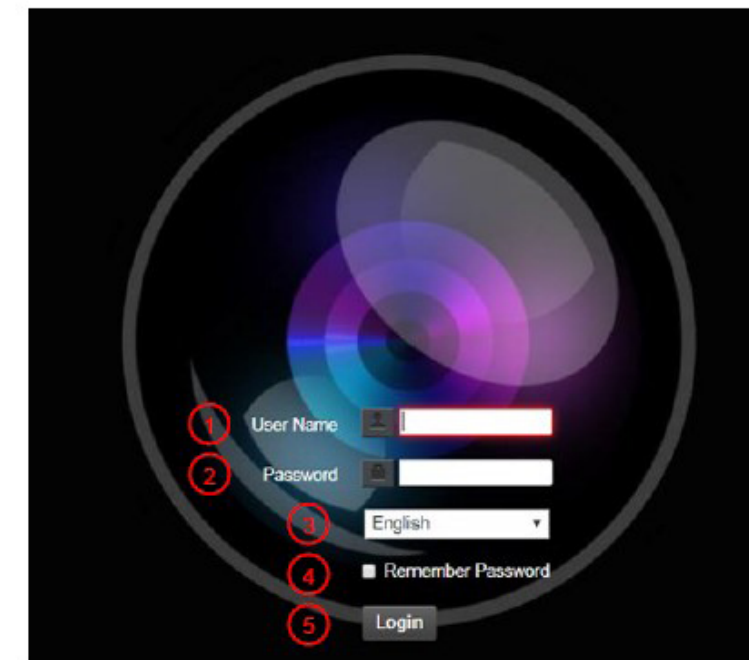

No	Item	Function Descriptions
1	Username	Enter user account (default: admin)
2	Password	Enter user password (default: 9999) * When log in for the first time, please refer to 5.2.3 Account Management to change the default password.
3	Language selection	Currently, the system supports English, Traditional Chinese and Simplified Chinese
4	Remember password	Save user account name and password to the browser. When you log in next time, there is no need to re-enter them
5	Login	Log into the administrator screen on the website

5.1.5 Using NDI Studio Monitor to View the Images

Applicable to CV620-BN/WN. Support when NDI|HX is on (Please refer to [5.2.4 Setting - Video -NDI|HX](#))

- For the NDI|HX operation, please download the latest NDI|Tools software from the NDI website <https://www.ndi.tv/tools/>

5.2.2 Viewing In Real Time

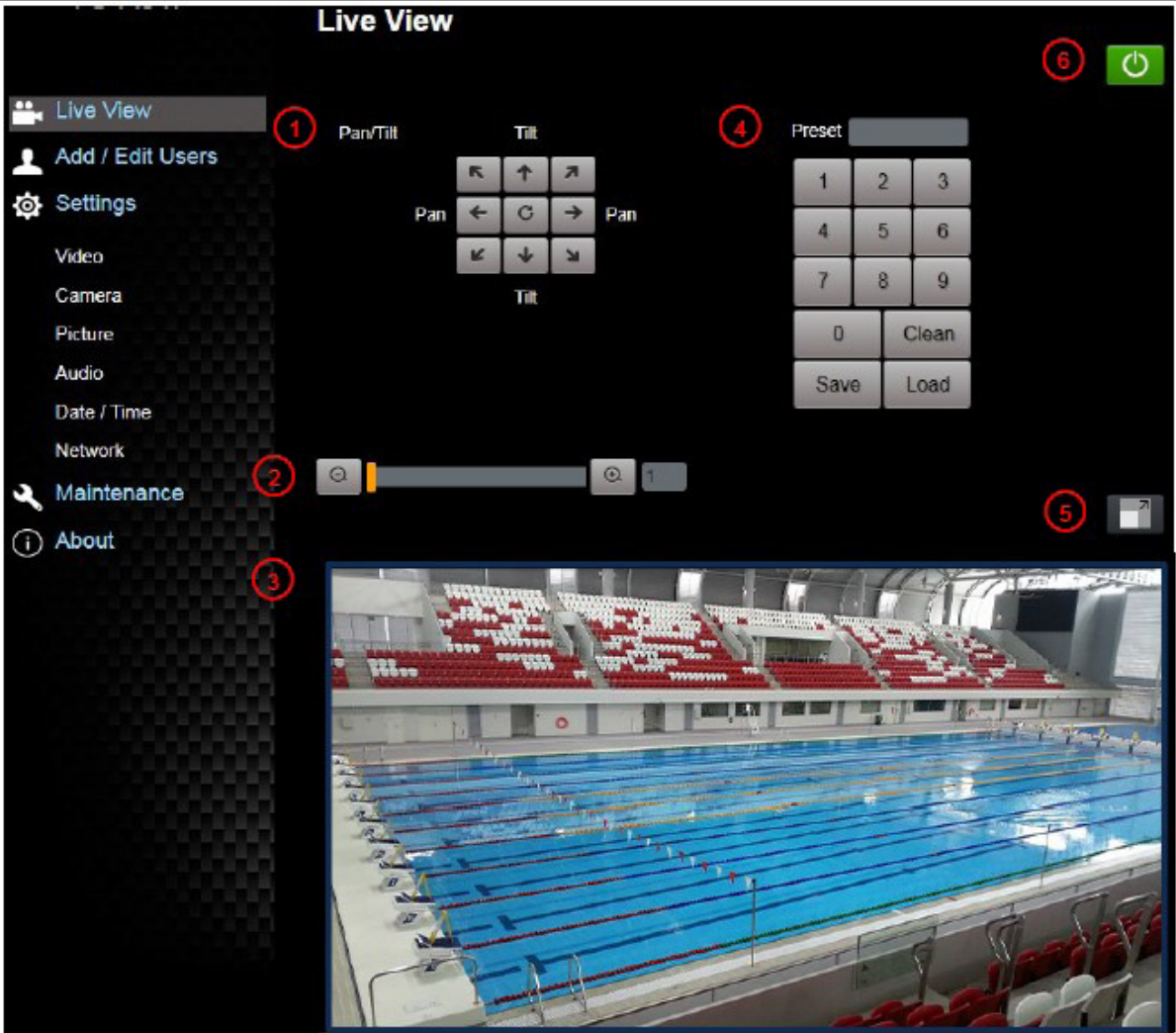

No	Item	Function Descriptions	CV620-BI/WI	CV620-BN/WN
1	Pan / Tilt setting	Adjust the Pan/Tilt position of the camera screen	v	v
2	Zoom ratio	Adjust the zoom-in or zoom-out ratio via scroll bar	v	v
3	Preview window	Display the screen currently captured by the camera	v	*Note 1
4	Preset setting	Select the number first and then select SAVE or LOAD	v	v
5	Switch to Full Screen	Switch the preview window to full screen	v	*Note 1
6	Power button	Turn on or turn off the camera power	v	v

*Note 1: Support when NDI|HX is Off

5.2.3 Account Management

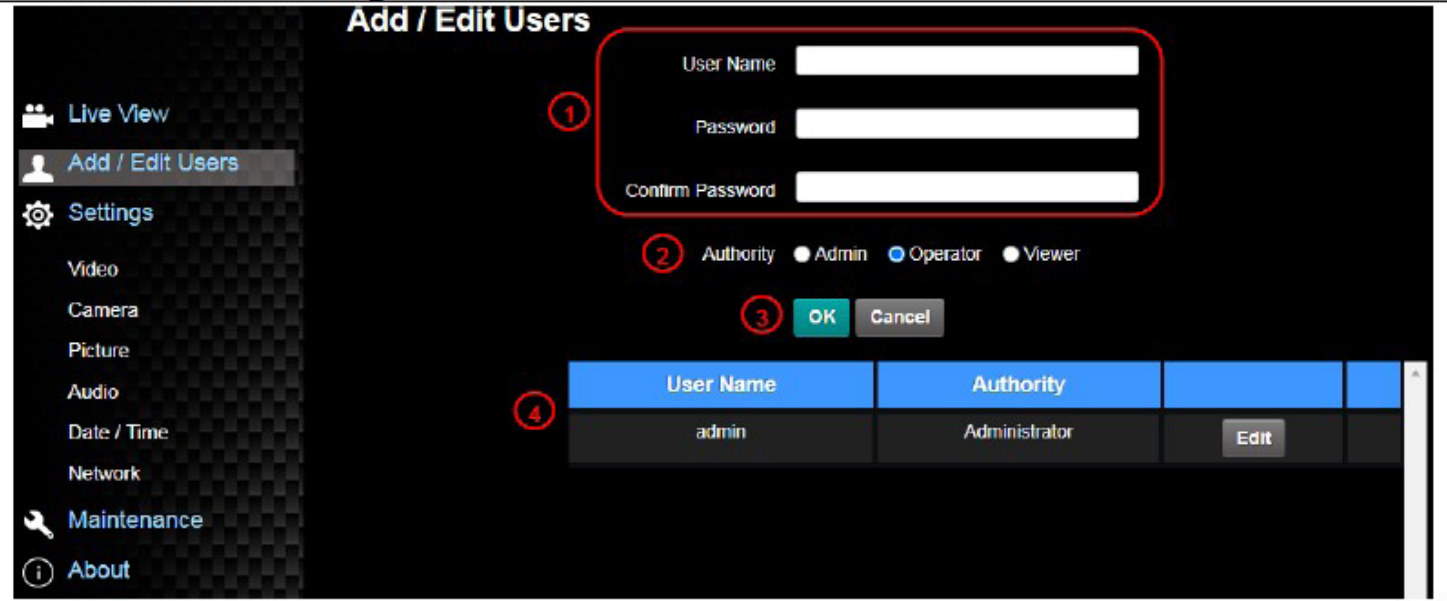

No	Item	Function Descriptions																
1	Add user account	Enter a username and password to add a new user																
2	Permission setting	Set the new account management permissions <table border="1" style="margin-left: 20px;"> <thead> <tr> <th>User Type</th> <th>Admin</th> <th>Operator</th> <th>Viewer</th> </tr> </thead> <tbody> <tr> <td>View images</td> <td>V</td> <td>V</td> <td>V</td> </tr> <tr> <td>Settings</td> <td>V</td> <td>V</td> <td>X</td> </tr> <tr> <td>Account management</td> <td>V</td> <td>X</td> <td>X</td> </tr> </tbody> </table>	User Type	Admin	Operator	Viewer	View images	V	V	V	Settings	V	V	X	Account management	V	X	X
User Type	Admin	Operator	Viewer															
View images	V	V	V															
Settings	V	V	X															
Account management	V	X	X															
3	Applying setting	Add the newly created user to the list of account																
4	List of accounts	Edit: Modify the user password and permissions Delete: Delete the user account																

5.2.4 Setting - Video

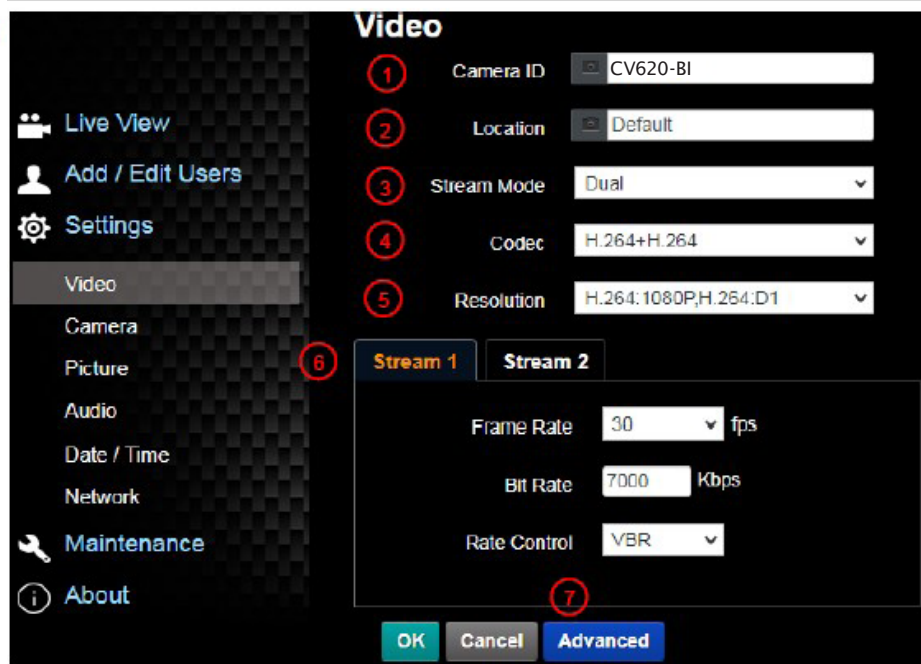

No	Item	Function Descriptions	CV620-BI/WI	CV620-BN/WN
1	Camera name	Change camera name here <ul style="list-style-type: none"> Camera names are limited to 1 - 11 characters Please use a camera name by mixing uppercase and lowercase letters or numbers. Do not use "/" and "space" or special symbols 	v	V
2	Camera Location	Modify the location of the camera, such as Room 1 <ul style="list-style-type: none"> Camera location is limited to 1 - 11 characters Please use a camera name by mixing uppercase and lowercase letters or numbers. Do not use "/" and "space" or special symbols 	v	v
3	NDI HX	CV620-BN/WN can turn NDI HX on/off On: Support NDI (ONVIF cannot find devices, and RTSP/RTMP/RTMPS/MPEG-TS/SRT streams cannot be used) Off: Support RTSP/RTMP/RTMPS/MPEG-TS/SRT, and ONVIF can find devices but cannot be used with NDI Tool	v	v
4	Streaming Mode	Choose from Single/Dual stream	v	*Note 1
5	Encode	Set the encode type <ul style="list-style-type: none"> H.264 + H.264 (Dual stream) H.264 + MJPEG (Dual stream) MJPEG (Dual stream) MJPEG (single stream) 	v	*Note 1
6	Resolution	Set Resolution	v	*Note 1
7	Streaming 1/Streaming 2	CV620-BI/WI supports 2-way streaming output <ul style="list-style-type: none"> Frame Rate: Setting according to the supported resolution Bit Rate (kbps) Streaming 1: 64 ~ 20,000, default 7,000 Streaming 2: 64 ~ 8,000, default 1,000 Rate Control: CBR / VBR 	v	*Note 1

8	Advanced	 <ul style="list-style-type: none"> IP Ratio: IP Ratio can be set from 1 to 60 depending on the supported resolution settings Encode Preset: <ul style="list-style-type: none"> Auto: Select between speed and quality depending on the encoding method used (e.g., HIGH_SPEED mode for refresh rate of 60 frames per second and HIGH_QUALITY mode for high image quality) HIGH_SPEED: Refresh rate of 60 frames per second is available HIGH_QUALITY: Higher image quality can be obtained SVC Auto: SVC opened encoding mode is applicable to RTSP streaming of 8601, 8602, 8603 and 8604 ports, different refresh rate for different ports. See 5.2.4.1 SVC description Encode Profile: Encoded data, support High Profile only 	v	*Note 1
---	----------	-----------------------------------------------------------------------------------------------------------------------------------------------------------------------------------------------------------------------------------------------------------------------------------------------------------------------------------------------------------------------------------------------------------------------------------------------------------------------------------------------------------------------------------------------------------------------------------------------------------------------------------------------------------------------------------------------------------------------------------------------------------------------------------------------------------------------------------------------------------------------------------------------------------------------------------------------	---	---------

*Note 1: Support when NDI|HX is Off

5.2.4.1 SVC description:

Link Address <rtsp://Cam IP Address:Port/h264>

- 60Frame: <rtsp://Cam IP Address:8557/h264>, e.g.: <rtsp://192.168.100.150:8557/h264>
- 30Frame: <rtsp://Cam IP Address:8601/h264>, e.g.: <rtsp://192.168.100.150:8601/h264>
- 15Frame: <rtsp://Cam IP Address:8602/h264>, e.g.: <rtsp://192.168.100.150:8602/h264>
- 7Frame: <rtsp://Cam IP Address:8603/h264>, e.g.: <rtsp://192.168.100.150:8603/h264>
- 3Frame: <rtsp://Cam IP Address:8604/h264>, e.g.: <rtsp://192.168.100.150:8604/h264>

5.2.5 Setting - Camera

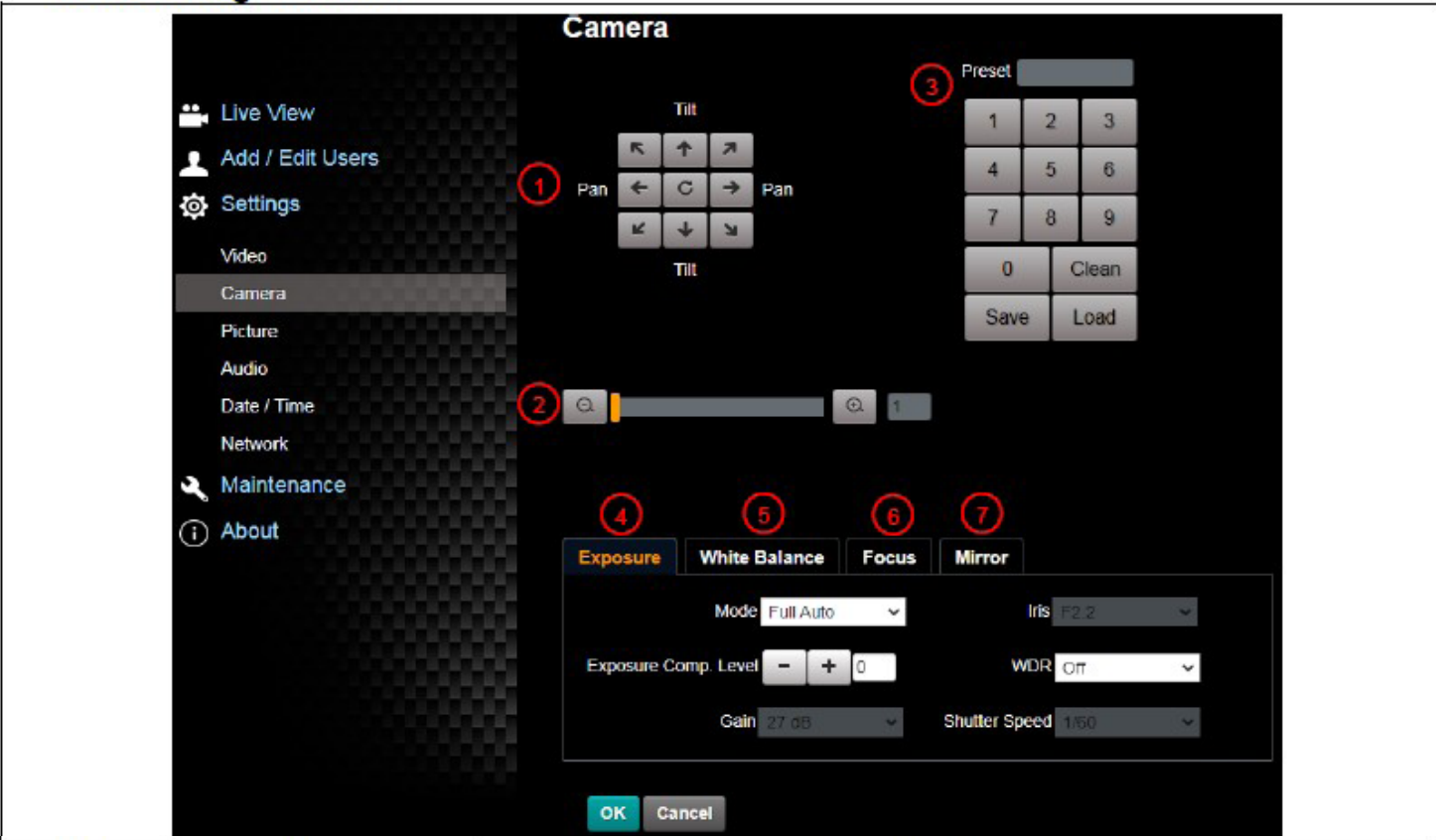

No	Item	Function Descriptions
1	Pan / Tilt setting	Adjust the Pan/Tilt position of the camera screen
2	Zoom ratio	Adjust the zoom-in or zoom-out ratio via scroll bar
3	Preset setting	Select the number first and then select SAVE or LOAD
4	Exposure	 <ul style="list-style-type: none"> ■ Mode: Select exposure mode (Automatic/Shutter Priority/Aperture Priority/Manual) ■ Exposure Comp. Level: Select exposure compensation level ■ Gain: The gain limit is adjustable when the exposure mode is set to "Manual" ■ Iris: The size of aperture is adjustable when the exposure mode is set to "Manual" or "Aperture Priority" ■ WDR: Set the level of wide dynamic range (WDR) to obtain better images ■ Shutter Speed: The shutter speed is adjustable when the exposure mode is set to "Manual" or "Shutter Priority"

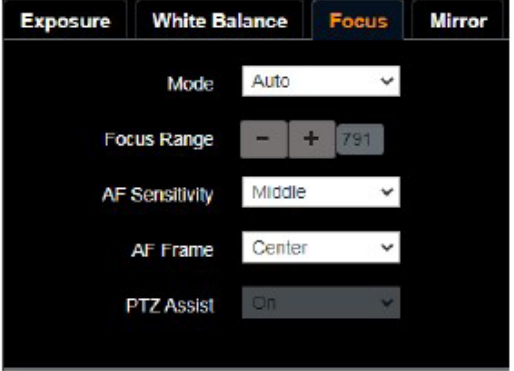
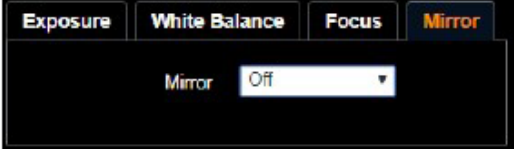
5	White Balance	 <ul style="list-style-type: none"> ■ Mode: Select the color temperature mode ➤ Auto/Indoor/Outdoor/One Push WB/ATW/Manual/Sodium Lamp/3000K/4300K/5000K/6500K/8000K/WideAuto ■ Open Push WB: One push color temperature is adjustable when the white balance mode is set to "One Push WB" ■ Manual Red/Blue: Manually adjust blue/red color temperature
6	Focus	 <ul style="list-style-type: none"> ■ Mode: Select manual/automatic focus ■ Focus Range: The focusing range is adjustable when the focus mode is set to "Manual" ■ AF Sensitivity: Set automatic focus sensitivity ■ AF Frame: Set automatic focus range ■ Preset AF: Set whether to perform auto focus after Preset
7	Mirror	 <ul style="list-style-type: none"> ■ Mirror: Set the mode at which the image is mirror and flipped ➤ Off / Mirror / Flip / Mirror + Flip

5.2.6 Setting - Picture

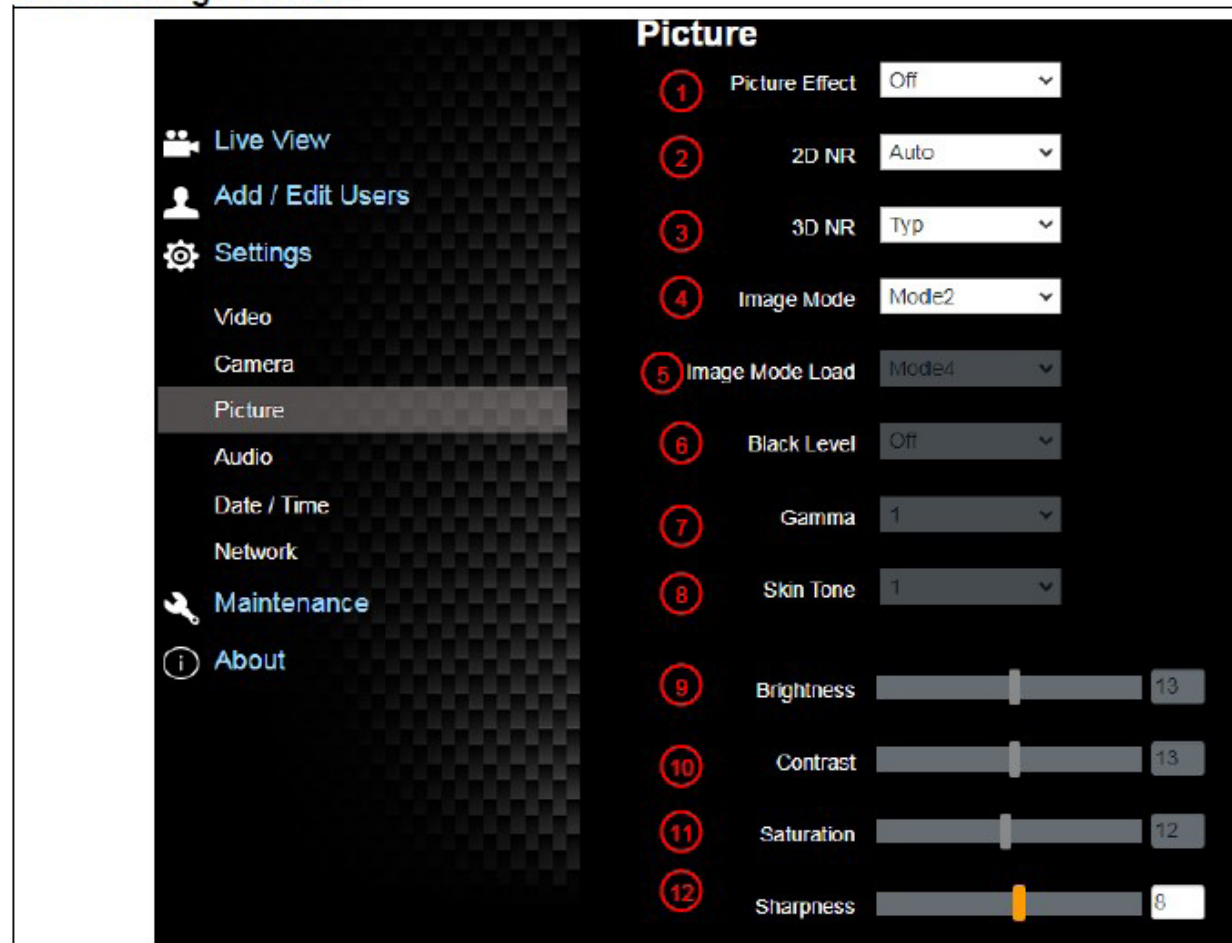

No	Item	Function Descriptions
1	Picture Effect	Set picture effect, Off/Neg/Black and White
2	2D noise reduction settings	2D noise reduction settings
3	3D noise reduction settings	3D noise reduction settings
4	Image mode	The user may customize his/her desired image mode
5	Image Mode Load	Adjustable when the Image mode is set to Custom. After selected, the corresponding Image mode parameters will be read and applied to Custom
6	Black Level	Black Level adjustment: Adjustable when the image mode is set to Custom
7	Gamma	Gamma Level adjustment: Adjustable when the image mode is set to Custom
8	Skin Tone	Skin Tone adjustment: Adjustable when the image mode is set to Custom
9	Brightness	Brightness adjustment: Adjustable when the image mode is set to Custom
10	Contrast	Contrast adjustment: Adjustable when the image mode is set to Custom
11	Saturation	Saturation adjustment of the image; Adjustable when the image mode is set to Custom
12	Sharpness	Adjust the sharpness of the image

5.2.7 Setting - Audio

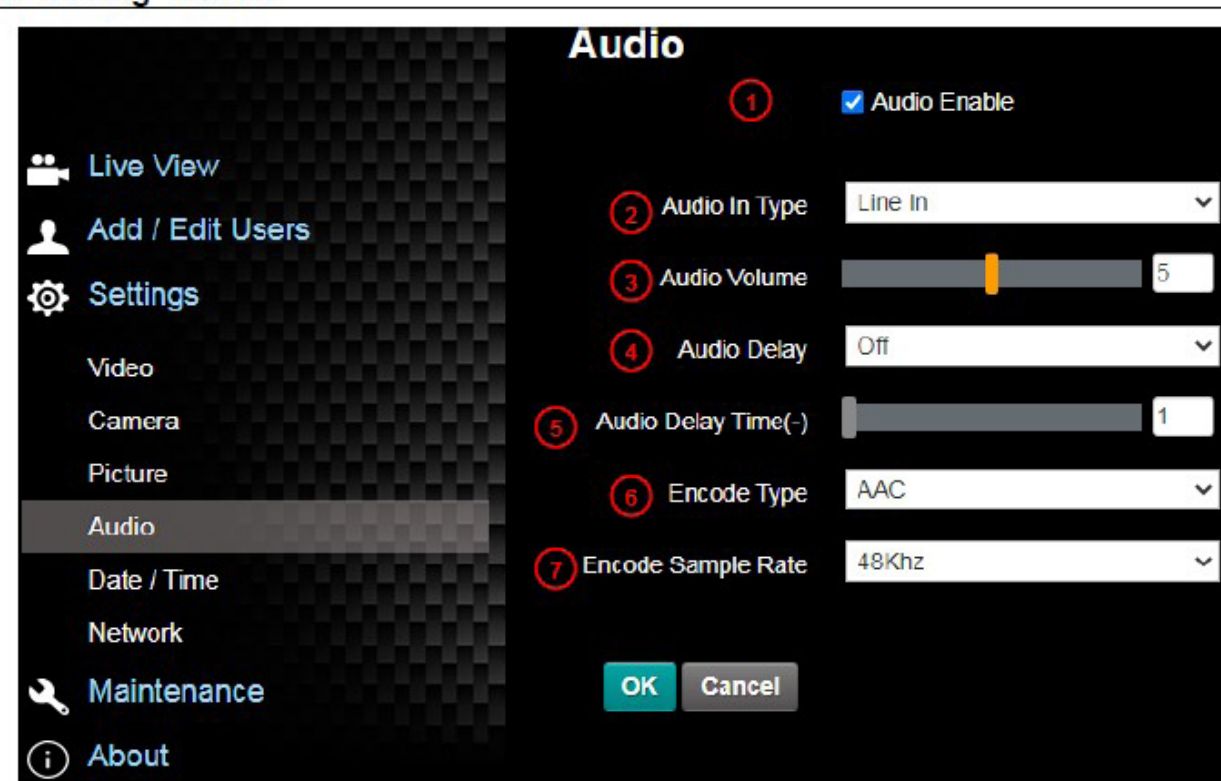

No	Item	Function Descriptions	VC-A51P	VC-A51PN
1	Open audio	Turn on/off sound	v	v
2	Soundtrack effect setting	Set MIC In/Line In	v	v
3	Volume	Adjust Volume	v	v
4	Audio delay	On / Off audio signal delay	v	*Note 1
5	Audio delay time	Set the audio signal delay time (-1 ~ -500 ms)	v	
6	Encode type	AAC / G.711	v	
7	Encode sample rate	Set Encode sample rate > 48 KHz (AAC) > 44.1 KHz (AAC) > 16 KHz (AAC) > 16 KHz (G.711) > 8 KHz (G.711) * CV620-BN/WN only supports 48 KHz (AAC)/44.1 KHz (AAC)	v	*Note 1

*Note 1: Support when NDI|HX is Off

5.2.8 Set - Time

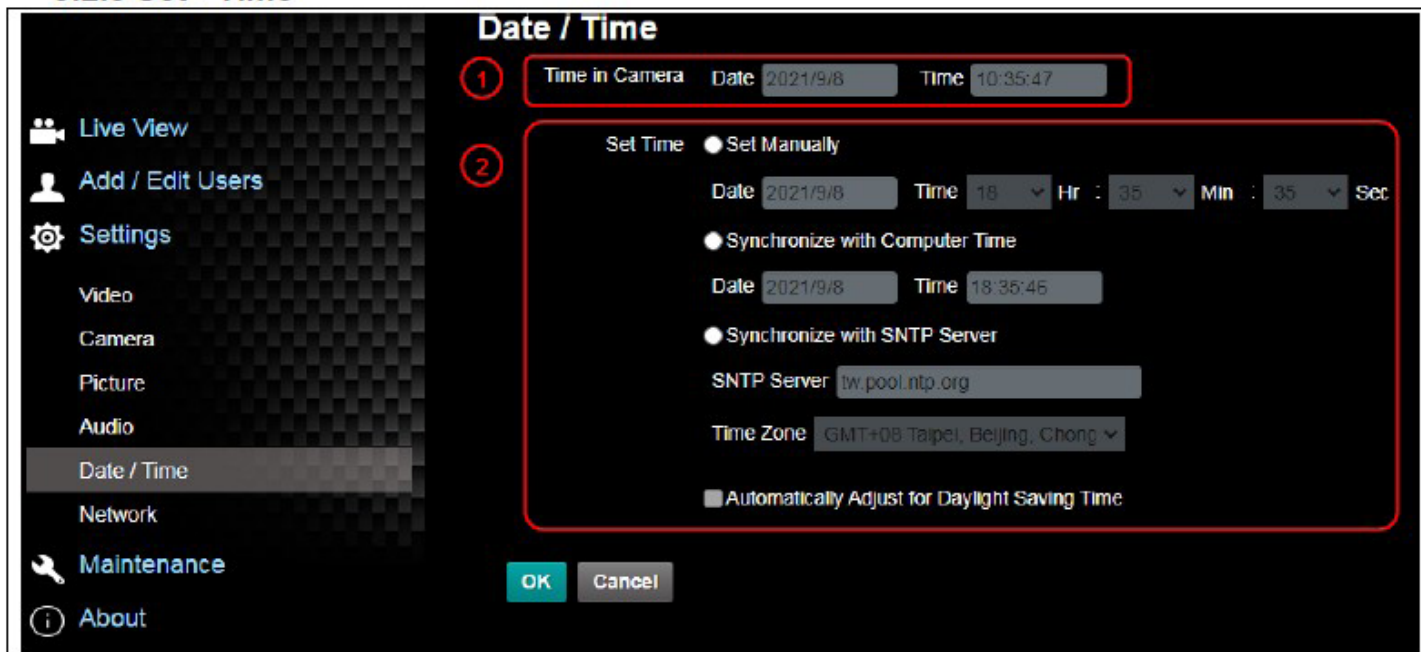

No	Item	Function Descriptions
1	Camera Time	Display the date and time of the current camera
2	Set the Time	<ul style="list-style-type: none"> Manual Configuration: Set time manually Synchronize with computer time: Set the camera time according to the computer time Synchronize with SNTP server: Set the camera time synchronously with the SNTP server ※ SNTP server address: Please go to 5.2.9 Settings-Network to make changes

Setting - Network

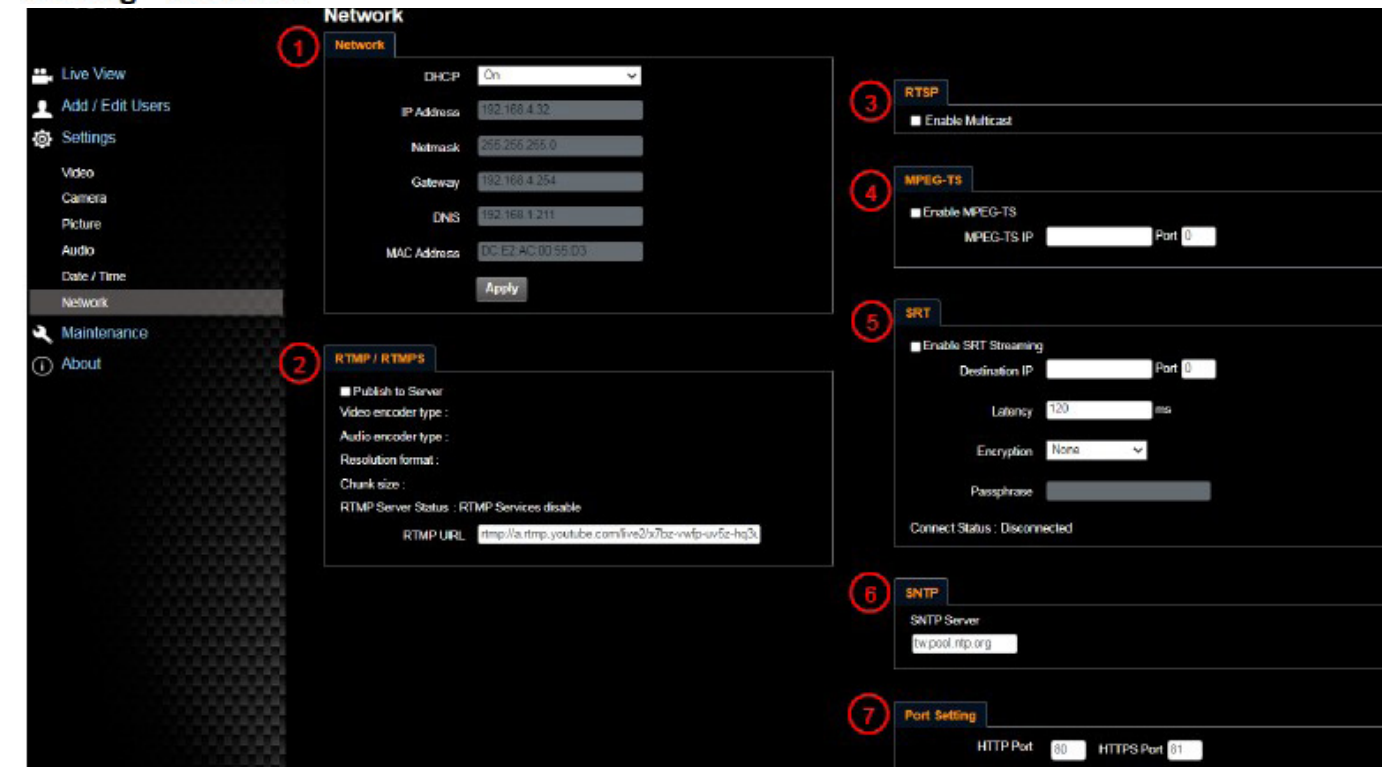

No	Item	Function Descriptions	CV620-BI/WI	CV620-BN/WN
1	Network	Network setting of camera. Change of setting is available when DHCP function is closed.	v	v
2	RTMP/RTMPS Setting	Copy the RTMP web address provided by the RTMP service platform and paste it to the RTMP connection address to publish the camera images on the RTMP service platform To upload to YouTube for live streaming, please refer to 5.2.7 Settings - Audio to turn on the audio function	v	
3	RTSP Setting	Enable/Disable Multicast It is suggested to enable Multicast when the number of users online watching the image simultaneously is more than 4 ■ Enable/Disable Password Authentication <ul style="list-style-type: none"> RTSP connection format can be found in 5.1.4 Using RTSP Players The username/password is the same as the web login password of the camera, please refer to 5.2.3 Account Management to add/modify account information 	v	*Note 1
4	MPEG-TS Setting	Set MPEG-TS format ※Port must be set in the range above 1024 with a maximum value of 9999 ※The following port is used by the camera. Setting of the port may not connect correctly 8554, 8556, 8557, 8080, 80, 81, 9090, 23	v	*Note 1

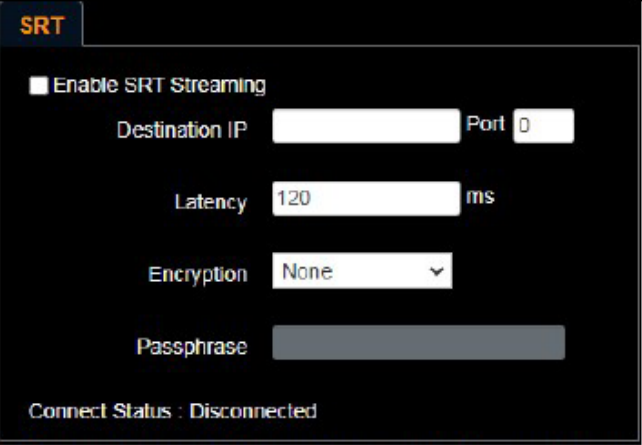
5	SRT Setting	 <p>1. Set the field of SRT and then check the item to open SRT streaming After the SRT streaming is opened, it will be connected automatically upon startup</p> <p>2. The port number must be set in the range above 1024 with a maximum value of 9999 * The following port is used by the camera. Setting of the port may not connect correctly 8554, 8556, 8557, 8080, 9090, 1935</p> <p>3. Delay time is for 20 to 8000 microseconds. The default value is 120 microseconds</p>	v	*Note 1
6	SNTP Setting	Set SNTP Server IP	v	v
7	Port Setting	Set HTTP port. The default Port value is 80	v	v

*Note 1: Support when NDI|HX is Off

5.2.9 Setting - Maintenance - Upgrading Firmware

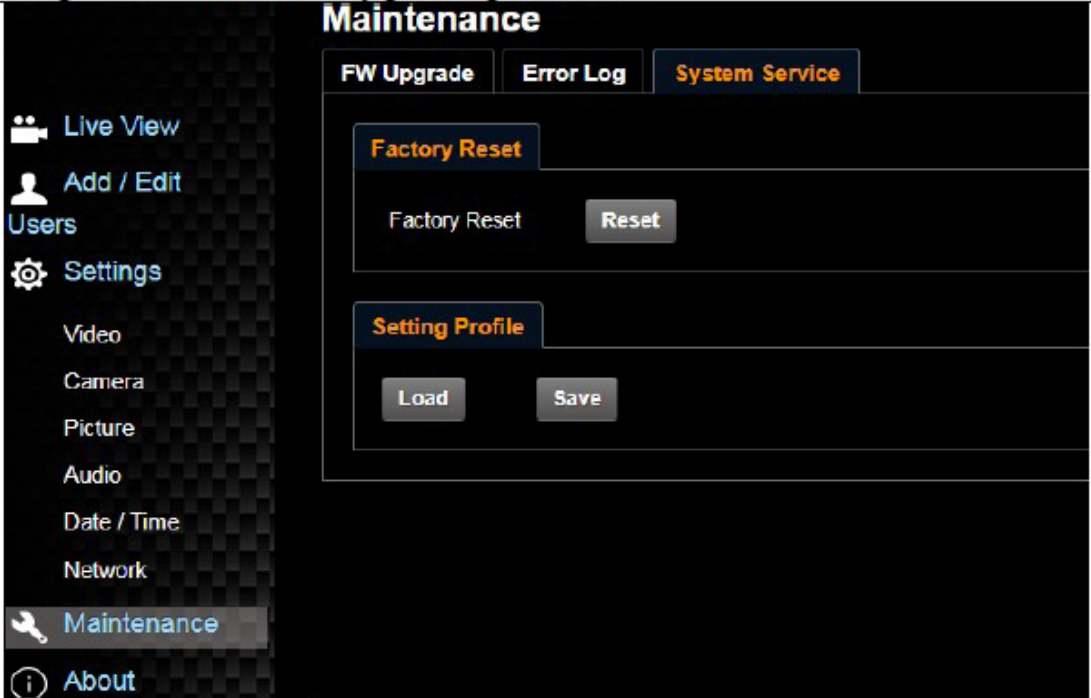
				
No	Item	Function Descriptions		
1	Firmware Update	The camera firmware can be updated via the web page Please go to the Lumens official website to download the latest firmware version and update the manual		

5.2.10 Setting - Maintenance - Incident Log

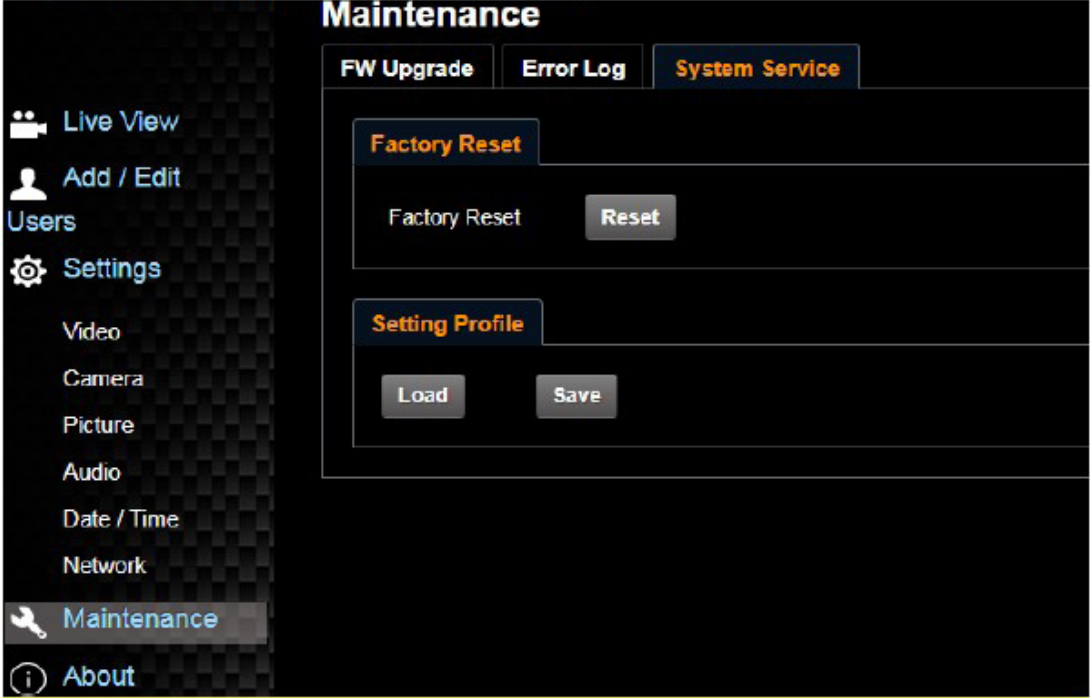
				
No	Item	Function Descriptions		
1	Event Logs	If the camera encounters errors, an error code log will be established When an error code appears, please try to clear it to reset and then see if issue persists.		

5.2.11 Setting - Maintenance - System Service

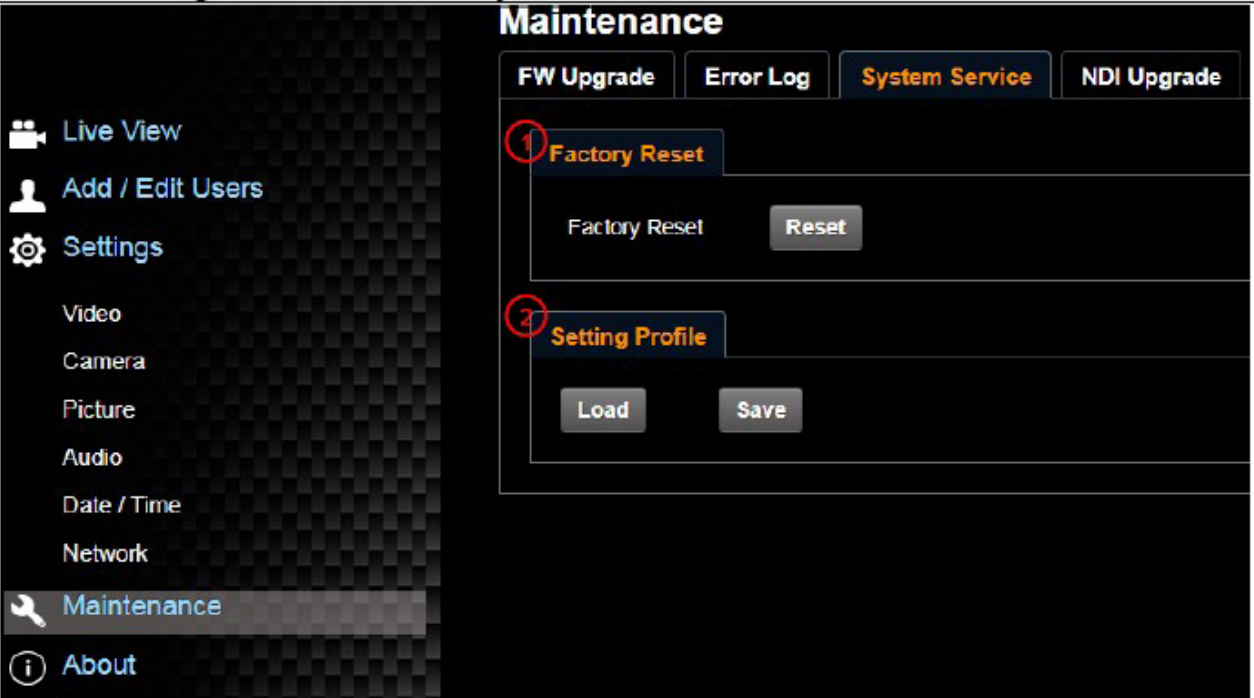
				
No	Item	Function Descriptions		
1	Reset to the default value	Select the reset button to resume the factory default setting as the web page setting		
2	Setting File	The web page setting parameters can be exported from the computer and imported/applied to another camera		

5.2.12 About

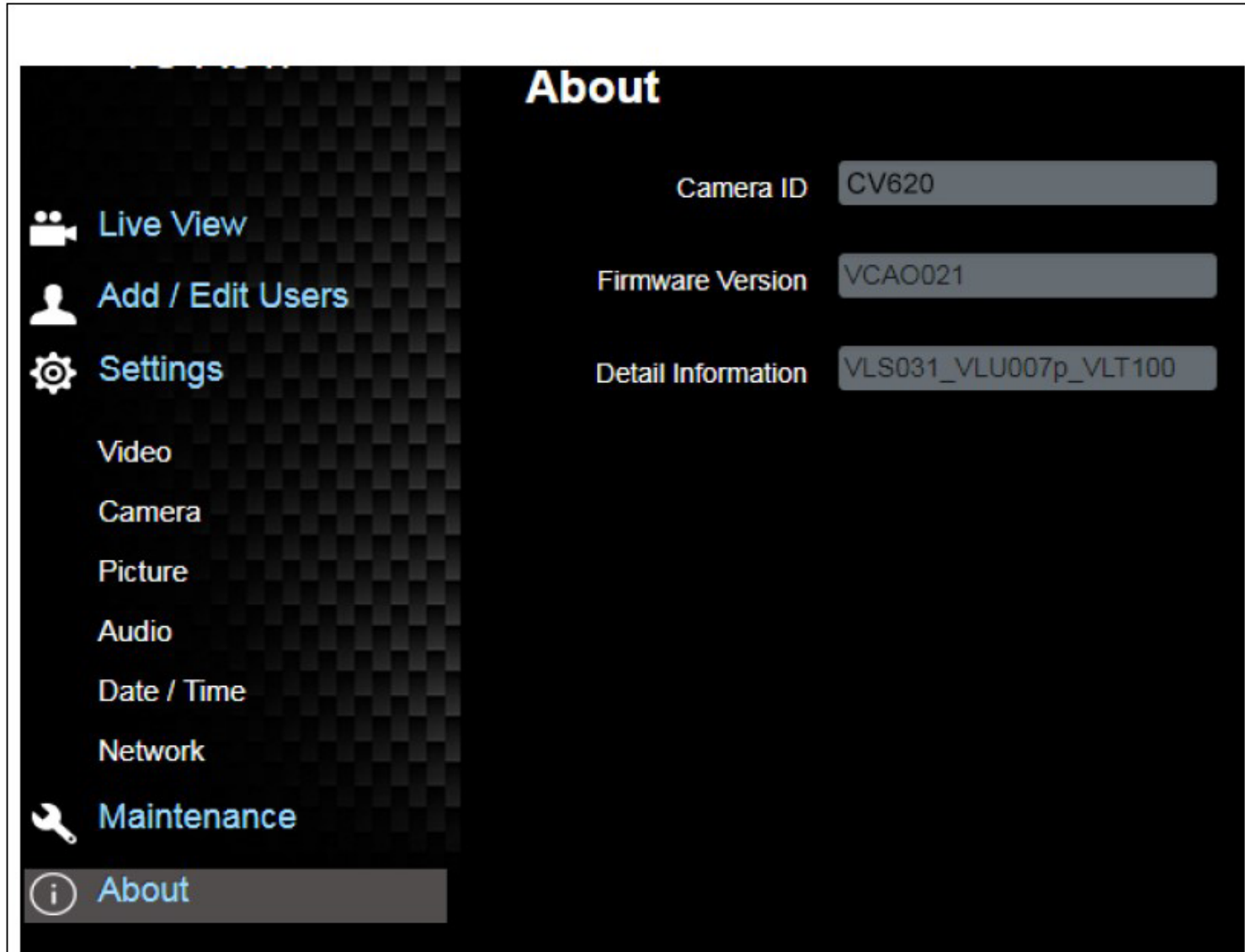

No	Item	Function Descriptions
1	Camera name	Display the current camera name
2	Firmware Version	Display the firmware version of the camera
3	Version Information	Display firmware version-related information

Chapter 6 DIP Switch Setting

6.1 OUTPUT Switch

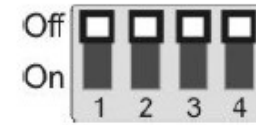

Output Mode	Setting	Output Mode	Setting
1920x1080/60p		1920x1080/50p	
1920x1080/30p		1920x1080/25p	
1920x1080/60i		1920x1080/50i	
1280x720/60p		1280x720/50p	
1080/59.94p		1080/59.94i	
1080/29.97p		720/59.94p	

6.2 IR SELECT



ID	Setting
1	
2	
3	

6.3 Camera Address Selector



Setting	Function Descriptions
0~7	ID 0~7
8~9	Reserved

6.4 System Switch

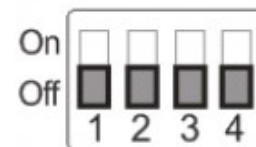

Setting	Function Descriptions
DIP 1	RS-232/RS-422 Communication Control OFF : RS-232 / ON : RS-422
DIP 2	IR signal output OFF : Off / ON : On
DIP 3	Communication baud rate OFF : 9600 / ON : 38400
DIP 4	Reserved

Chapter 7 Troubleshooting

This chapter describes problems you may encounter while using CV620-BI/WI or CV620-BN/WN. If you have questions, please refer to related chapters and follow all the suggested solutions. If the problem still occurred, please contact your distributor or the service center.

No.	Problems	Solutions
1.	Boot without power signal	1. Make sure you have plugged in the power cord. 2. When using a PoE connection, ensure that the power supply supports POE+ (IEEE 802.3at) hubs
2.	There is no image output from the camera	1. Check the power supply or PoE supply functions. 2. Confirm the output signals are in streaming output. 3. Confirm whether the camera resolution can be used together with the monitor equipment 4. Replace the cables and make sure they are not faulty.
3.	The Camera image is severely delayed	Please use 1080p or 720p 60/50 fps rather than 25/30 fps signals.
4.	RS-232 cannot be controlled	1. Confirm the connection is correct (RS-232 In/ Out) 2. Please make sure the Baud rate setting is the same as the control equipment
5.	Whether the Internet can be used for operation	Please refer to Chapter 5 Network Function Description for the Internet usage
6.	The ONVIF software cannot find the machine	Please make sure that [Setting]> [Video]> [Camera ID]/[Location] in the web page uses only English letters or numbers. The ONVIF software cannot find the machine if you use special characters and space. For CV620-BN/WN, ONVIF is supported only after NDI HX is turned off. Please make sure [Setting]>[Video]>[NDI HX] is set to [Off] in the webpage.
7.	Tally light is not working when applying RS232 setting	Please make sure if the Tally lamp function is enabled from the setting menu or web page. Setting Menu: System - Tally Lamp
8.	The camera does not save the relevant parameters (PTZ, AWB ...) after reboot	Please make sure if the Initial Position is set to Last Operated Position from the setting menu or web page Setting Menu: System - Initial Position

Chapter 8 Safety Instructions

Always follow these safety instructions when using the product:

- 1 **Operation**
 - 1.1 Please use the product in the recommended operating environment, away from water or source of heat.
 - 1.2 Do not place the product in tilted position or unstable trolley, stand or table.
 - 1.3 Please clean the dust on the power plug prior to usage. Do not insert the product's power plug into a multiplug to prevent sparks or a fire.
 - 1.4 Do not block the slots and openings in the case of the product. They provide ventilation and prevent the product from overheating.
 - 1.5 Do not open or remove covers, otherwise it may expose you to dangerous voltages and other hazards. Refer all servicing to licensed service personnel.
 - 1.6 Unplug the product from the wall outlet and refer servicing to licensed service personnel when the following situations happen:
 - If the power cords are damaged or frayed.
 - If liquid is spilled into the product or the product has been exposed to rain or water.
- 2 **Installation**
 - 2.1 For security considerations, please make sure the standard hanging rack you bought is in line with UL or CE safety approbations and installed by technician personnel approved by agents.
- 3 **Storage**
 - 3.1 Do not place the product where the cord can be stepped on as this may result in fraying or damage to the lead or the plug.
 - 3.2 Unplug the product during thunderstorms or if it is not going to be used for an extended period.
 - 3.3 Do not place the product or accessories on top of vibrating equipment or heated objects.
- 4 **Cleaning**
 - 4.1 Disconnect all the cables prior to cleaning and wipe the surface with a dry cloth. Do not use alcohol or volatile solvents for cleaning.
- 5 **Batteries (for products or accessories with batteries)**
 - 5.1 When replacing batteries, please only use similar or the same type of batteries.
 - 5.2 When disposing of batteries or products, please adhere to the relevant instructions in your country or region for disposing of batteries or products.

■ Precautions



This symbol indicates that this equipment may contain dangerous voltage which could cause electric shock. Do not remove the cover (or back). No user-serviceable parts inside. Refer servicing to licensed service personnel.



This symbol indicates that there are important operating and maintenance instructions in this User Manual with this unit.

■ FCC Warning

This equipment has been tested and found to comply with the limits for a Class A digital device, pursuant to part 15 of the FCC Rules. These limits are designed to provide reasonable protection against harmful interference when the equipment is operated in a commercial environment.

Notice:

The changes or modifications not expressly approved by the party responsible for compliance could void the user's authority to operate the equipment.

This equipment has been tested and found to comply with the limits for a Class A digital device, pursuant to part 15 of the FCC Rules. These limits are designed to provide reasonable protection against harmful interference when the equipment is operated in a commercial environment.

■ IC Warning

This digital apparatus does not exceed the Class A limits for radio noise emissions from digital apparatus as set out in the interference-causing equipment standard entitled "Digital Apparatus," ICES-003 of Industry Canada. Cet appareil numérique respecte les limites de bruits radioélectriques applicables aux appareils numériques de Classe A prescrites dans la norme sur le matériel brouilleur: "Appareils Numériques," NMB-003 édictée par l'Industrie.

■ EN55032 CE Warning

Operation of this equipment in a residential environment could cause radio interference.

Warning: Operation of this equipment in a residential environment may cause radio interference

Warranty

For Warranty information please refer to Marshall website page:

<https://marshall-usa.com/company/warranty.php>

Marshall

20608 Madrona Avenue, Torrance, CA 90503

Tel: (800) 800-6608 / (310) 333-0606 • Fax: 310-333-0688

www.marshall-usa.com

support@marshall-usa.com