



# VC9101

## Split-type Camera System

---

5MP, H.265, 30fps, Face Check, 3DNR, SNV

- Discreet, Recessed-Mount Camera Units
- Supports 1 Camera Unit
- 4 Camera Options: 4MP WDR Pinhole, 4MP WDR Pinhole Flat, 5MP WDR Fisheye, 5MP WDR Fisheye Flat
- Two-Way Audio on Video Core
- WDR Pro (120 dB) for Improved Visibility in High Contrast Scenes
- Face Check - Smart Motion Detection
- Video Rotation for Corridor View
- Trend Micro IoT Security





## Overview

VIVOTEK's VC9101 is a high-performance split-type camera system. Its discreet design, rich functionality and ability to be flexibly integrated into even the tightest spaces, make this camera ideal for indoor or covert surveillance of ATMs, banks, stores and offices.

The VC9101 features a separate camera unit (CU series) and video core design, enabling the tiny camera unit (with 5-meter long cable) to be easily and flexibly installed into any decoration or interior design, thus preserving stylish appearances while dramatically saving on installation time and cost.

VC9101 video core has a powerful processor which can stream a 5MP 360 degree fisheye image or a 4MP 16:9 image. Furthermore, the VC9101 is equipped with CNN (Convolutional Neural Network) hardware accelerator which allows the deep learning VCA be more efficient and powerful. VC9101 also provides deep learning based face detection suitable for most installation scenarios.

The VC9101 camera core can support one camera unit and is designed to work in perfect harmony with a choice of 4 different types of camera units, CU9171-H, CU9171-HF, CU9183-H and CU9183-HF. The whole system incorporates a number of advanced features found in VIVOTEK cameras, including WDR Pro, SNV, Smart Stream III technology, 3DNR, and security features like secure boot, signed firmware, and Trend Micro cybersecurity.



# Technical Specifications

## Specifications - Video Core

Model	VC9101
-------	--------

### System Information

CPU	Multimedia SoC (System-on-Chip)
Flash	8 GB
RAM	2 GB
On-board Storage	Seamless Recording to MicroSD/SDHC/SDXC card (1TB capacity supported) and recording to network-attached storage (NAS)

### Video

Compression	H.265, H.264, MJPEG
Video Source	1 VIVOTEK camera unit
Maximum Streams	3 video streams (Up to 8 configurable profiles)
Video Streaming	Adjustable resolution, quality and constant bit rate control, Smart Stream III
Image Settings	General settings: video title and time stamp overlay, video orientation (flip, mirror, rotation (CU9171-H(F) only)); Image settings: white balance, image adjustment (brightness, contrast, saturation, sharpness, gamma curve (CU9171-H(F) only)), defog, 3DNR, HLM, scene mode (auto, deblur); Exposure: BLC, HLC, exposure control (exposure level, exposure time, gain control) AE speed adjustment, WDR; Privacy mask; Pixel calculator
Display Mode	Client dewarping (CU9183-H(F) only) Ceiling mounted: 1O Fisheye, 1P Panoramic, 2P Two Panoramic, 1R One Region, 4R Four Regions, 1O3R One Fisheye Three Regions, 1O8R One Fisheye Eight Regions Wall mounted: 1O Fisheye, 1P Panoramic, 1R One Region, 4R Four Regions, 1P2R One Panoramic Two Regions, 1P3R One Panoramic Three Regions, 1O3R, One Fisheye Three Regions  Local dewarping (CU9183-H(F) only) Ceiling mounted: 1O Fisheye, 1P Panoramic, 2P Two Panoramic, 1R One Region, 4R Four Regions Wall mounted: 1O Fisheye, 1P Panoramic, 1R One Region, 4R Four Regions

### Audio

Audio Capability	Two-Way Audio (full duplex)
Compression	G.711, G.726
Interface	External microphone input External line output

### Network

Users	Live viewing for up to 10 clients
Security	Access list, digest authentication, HTTPS, IEEE 802.1x, Password protection, secure boot, signed firmware, Trend Micro IoT Security (brute force attack event, cyberattack event, quarantine event), user access log, user account management, CSRF protection
Protocols	802.1X, ARP, Bonjour, CIFS/SMB, CoS, DDNS, DHCP, DNS, FTP/SFTP, HTTP, HTTPS, ICMP, IGMPv3, IPv4, IPv6, NTP, PPPoE, QoS, RTSP/RTP/RTCP, SMTP, SNMP, SSL, TCP/IP, TLS, UDP, UPnP
Interface	10 Base-T/100 Base-TX Ethernet (RJ-45) *It is highly recommended to use standard CAT5e & CAT6 cables which are compliant with the 3P/ETL standard.
ONVIF	Profile G, S, T supported, specification available at <a href="http://www.onvif.org">www.onvif.org</a>

### Solution Integration

Smart Motion Detection	Five-window video motion detection, face detection, time filter
------------------------	---

### Alarm and Event

Alarm Triggers	Audio detection, camera tampering detection, cybersecurity events (brute force attack event, cyberattack event, quarantine event), digital input, manual trigger, motion detection, periodical trigger, recording notification, SD card life expectancy, system boot
Alarm Events	Event notification via audio clip, camera link, digital output, email, HTTP, FTP/SFTP, NAS server, SD card, push notification File upload via email, HTTP, FTP/SFTP, NAS server, SD card

### General



Connectors	RJ-45 cable connector for 10/100Mbps Network/PoE connection Audio line input Audio line output DC 12V power input Digital input *1 Digital output *1 (12V, 50mA)
LED Indicator	System power and status indicator
Power Input	DC 12V, IEEE 802.3af PoE Class 0 Simultaneous Power Redundancy Supported
Power Consumption	Max. 8.5 W
Dimensions	105 (W) x 84 (D) x 30 (H) mm
Weight	190 g
Safety Certifications	EMC: CE (EN55032, EN55024 Class B), FCC (FCC Part 15 Subpart B Class B), RCM (AS/NZS CISPR32 Class B), VCCI (VCCI-CISPR 32 Class B); Safety: UL (UL62368-1), CB (IEC/EN 62368-1, IEC/EN 60950-22, IEC/EN 62471); Environment: IA: BSMI (EMC: CNS 13438, Safety: CNS 14336-1)
Operating Temperature	Starting Temperature: 0°C ~ 50°C (32°F ~ 122°F) Working Temperature: -10°C ~ 50°C (14°F ~ 122°F)
Humidity	90% RH (non-condensing)
Warranty	36 months

#### System Requirements

Operating System	Microsoft Windows 10/8/7 Mac 10.12 (Chrome only)
Web Browser	Chrome 58.0 or above Internet Explorer 10/11
Other Players	VLC: 1.1.11 or above

#### Included Accessories

Packing Contents	Quick installation guide, installation kit
------------------	--

#### Specifications - Camera Unit

Model	CU9171-H(F): Pinhole
Image Sensor	1/2.7" Progressive CMOS
Maximum Resolution	30 fps @ 2688x1520
Focal Length	f = 3.7 mm
Aperture	F2.5
Field of View	93° (Horizontal) 48° (Vertical) 117° (Diagonal)
Shutter Time	1/5 sec. to 1/32,000 sec.
WDR Technology	WDR Pro
Minimum Illumination	0.045 lux @ F2.5 (Color)
Pan/Tilt/Zoom Functionalities	ePTZ: 48x digital zoom (4x on IE plug-in, 12x built-in)
S/N Ratio	55.9 dB
Dynamic Range	120 dB
Dimensions	CU9171-H: Ø 24 x 30 mm (Without cable) CU9171-HF: 33 x 32 x 20 mm (Without cable)
Weight	CU9171-H: 19g CU9171-HF: 43g
Operating Temperature	Starting Temperature: 0°C ~ 50°C (32°F ~ 122°F) Working Temperature: -10°C ~ 50°C (14°F ~ 122°F)
Humidity	90% RH (non-condensing)

#### Specifications - Camera Unit

Model	CU9183-H(F): Fisheye Camera
Image Sensor	1/2.7" Progressive CMOS
Maximum Resolution	30 fps @ 1920x1920

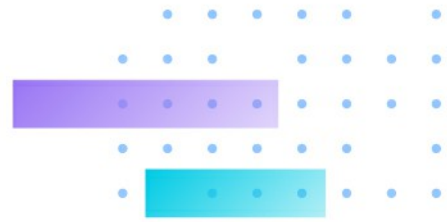

Focal Length	f = 1.22 mm
Aperture	F2.0
Field of View	180° (Horizontal) 180° (Vertical) 180° (Diagonal)
Shutter Time	1/5 sec. to 1/32,000 sec.
WDR Technology	WDR Pro
Minimum Illumination	0.035 lux @ F2.0 (Color)
Pan/Tilt/Zoom Functionalities	ePTZ: 48x digital zoom (4x on IE plug-in, 12x built in)
S/N Ratio	56.3 dB
Dynamic Range	120 dB
Dimensions	CU9183-H: Ø 24 x 37 mm (Without cable) CU9183-HF: 33 x 32 x 28 mm (Without cable)
Weight	CU9183-H: 28g CU9183-HF: 52g
Operating Temperature	Starting Temperature: 0°C ~ 50°C (32°F ~ 122°F) Working Temperature: -10°C ~ 50°C (14°F ~ 122°F)
Humidity	90% RH (non-condensing)
<b>DORI (EN 62676-4 Standard)</b>	
Detect (25PPM/ 8PPF)	CU9171-H(F): 77 m (252.6 ft) CU9183-H(F): 24.3 m (79.7 ft)
Observe (63PPM/ 19PPF)	CU9171-H(F): 30.5 m (100.1 ft) CU9183-H(F): 9.6 m (31.5 ft)
Recognize (125PPM/ 38PPF)	CU9171-H(F): 15.4 m (50.5 ft) CU9183-H(F): 4.8 m (15.7 ft)
Identify (250PPM/ 76PPF)	CU9171-H(F): 7.7 m (25.3 ft) CU9183-H(F): 2.4 m (7.9 ft)

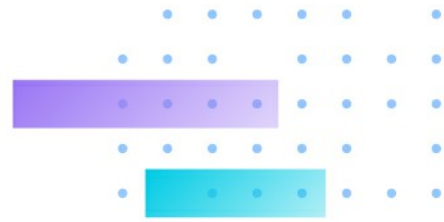

## Dimensions

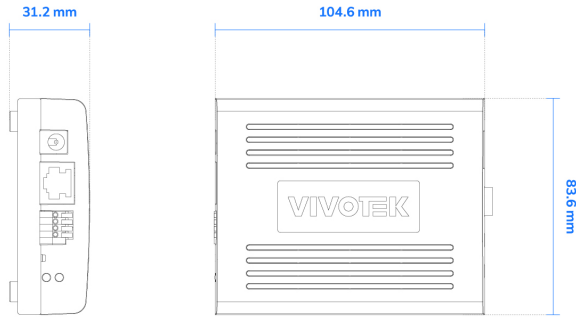

CU9171-H

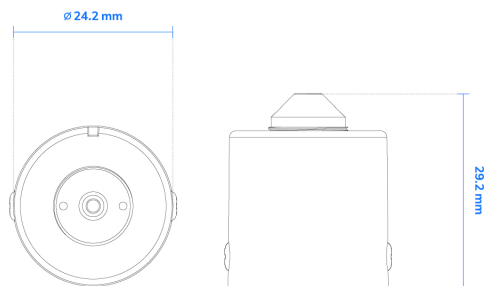

CU9171-HF

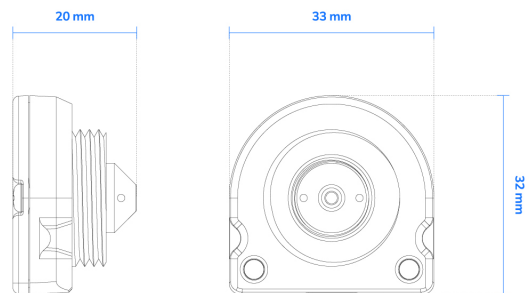

CU9183-H

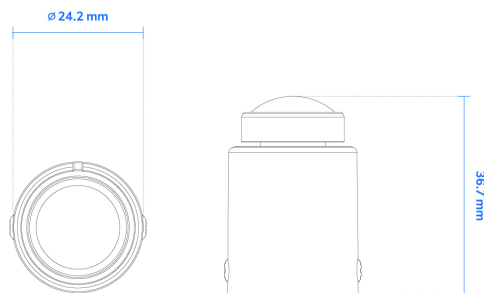

CU9183-HF

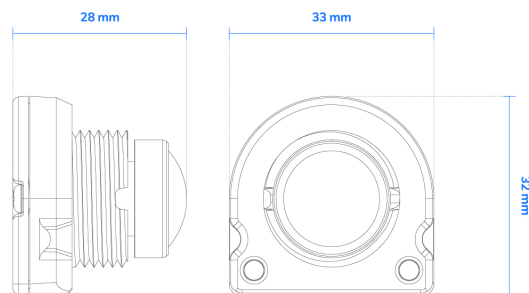

## Ordering Information

Model	Description	Part Number
VC9101	Video Core, H.265/H.264/MJPEG, PoE/DC, I/O*1/1, Two-Way Audio	100274100G
CU9171-H	Camera Unit, Cylinder Shape, 4M 30 fps, Pinhole Lens	100274200G
CU9183-H	Camera Unit, Cylinder Shape, 5M 30 fps, Fisheye Lens	100274300G
CU9171-HF	Camera Unit, Flat Shape, 4M 30 fps, Pinhole Lens	100274400G
CU9183-HF	Camera Unit, Flat Shape, 5M 30 fps, Fisheye Lens	100274500G

**VIVOTEK**

All specifications are subject to change without notice. Copyright©VIVOTEK INC. All rights reserved. Ver. 2