

ST

C **UL** US
LISTED

Technical Data Sheet

File No. E471457

Beta 10P/20P/30P/40P



The digital panel meter Beta P Series have been designed for industrial applications, which frequently require precise and on site adjustment of the display range.

Special Features

- Fast & Easy Installation on panel without any need of external swivel screws
- 4 Digits ultra bright LED Display (up to 9999)
- On site Programmable CT/PT Ratios
- User selectable CT Secondary 1A/5A
- User selectable PT Secondary from 100 VLL to 500 VLL
- User selectable 3ph-3wire / 3ph-4wire / single phase Network
- Wide auxillary Power Supply which can accept any input between
- 40V- 300V AC/DC

Application

The digital panel meter Beta P Series have been designed for industrial applications, which frequently require precise and on site adjustment of the display range. It can be used in industrial automation and for laboratory uses.

Product Features:

True RMS measurement	The instrument measures distorted waveform up to 15 th Harmonic.	Screen No. storage	In case of power failure, the instrument memorizes the last screen stored. For every 1 min. the instrument stores the screen no. in the non-volatile memory.
On site programmable PT/CT ratios	It is possible to program primary of external potential Transformer (PT) for Voltage DPM & primary of external Current Transformer (CT) for Current DPM on site via front panel keys by entering into Programming mode.	Min Max storage of parameters possible	The instrument stores minimum and maximum values for System Voltage (in case of Beta 20P / Beta 40P) and System Current (in case of Beta 10P / Beta 30P). Every 60 sec stored values are updated.
User selectable CT Secondary 5A/1A	The secondary of external Current Transformer (CT) can be programmed on site to either 5A or 1A for Current DPM using front panel keys.	Low back depth	The instrument has very low back depth (behind the panel) of less than 54mm for 96x96 and 68mm for 48x96 type DPM.
User selectable PT Secondary	The secondary of external Potential Transformer (PT) can be programmed on site from 100 VLL to 500 VLL for Voltage DPM using front panel keys.	Available in two different Sizes	DPM is available in two different sizes 96x96 and 48x96.
Higher Security	Provides Security with user programmable password protection.	Enclosure Protection for dust and water	Conforms to IP 50 (for front face) & IP 20 (for back) as per IEC60529.
User selectable CT Primary	The Primary of current transformer can be programmed on site from 1A to 999kA for Current DPM using front panel keys.	EMC Compatibility	Compliance to International standard IEC 61326.
User selectable PT Primary	The Primary of Potential transformer can be programmed on site from 60 VLN to 999 kVLN for single Phase Voltage DPM & 100VLL to 999 kVLL for three Phase Voltage DPM using front panel keys.	Interference Emission	IEC 61326-1 2005, Class A
User selectable 3 phase 3Wire or 4Wire or Single phase Network	User can program on site the network connection as either 3 Phase 3 Wire or 4 Wire or single phase network using front panel keys.	Interference Immunity	IEC 61326-1 2005
Onsite selection of Auto scroll/ Fixed Screen	User can set the display in auto scrolling mode or fixed screen mode using front panel keys.	Electrostatic disc (ESD) arge	IEC 61000-4-2 -- 4kV/8kV contact/air.
4 digits LED display (up to 9999)	14mm ultra bright 4 digits LED display.	EM Field	IEC 61000 -4-3 -- 10 V/m (80 MHz to 1 GHz) -- 3 V/m (1.4 GHz to 2 GHz) -- 1 V/m (2 GHz to 2.7 GHz)
Function keys	Using two function keys it is possible to Display various parameters in Current and Voltage DPM. These function keys are also used for programming Password, Network selection, CT/PT Primary & Secondary values, Reset min/max values, Auto ON/OFF mode selection.	Burst	IEC 61000 -4-4 -- 2 kV (5/50 ns, 5 kHz)
		Surge	IEC 61000 -4-5 -- 1 kVLL / 2 kVLN.
		Conducted RF	IEC 61000 -4-5 -- 3 V (150 kHz to 80 MHz)
		Rated Power Frequency magnetic Field	IEC 61000 -4-8 -- 30 A/m
		Voltage dip	IEC 61000 -4-11 -- 0% during 1 cycle. -- 40% during 10/12 cycles. -- 70% during 25/30 cycles.
		Short interruptions	IEC 61000-4-11 -- 0% during 25/30 cycles. 25 cycles for 50 Hz test 30 cycles for 60 Hz test.

Technical Specifications

Accuracy	
Voltage	±0.5% of range + 1 Digit (10... 100% of Nominal value)
Current	±0.5% of range + 1 Digit (10... 100% of Nominal value)

Reference conditions for Accuracy	
Reference temperature	23°C +/- 2°C
Input waveform	Sinusoidal (distortion factor 0.005)
Input frequency	50 or 60 Hz ±2%
Auxiliary supply voltage	Rated Value ±1%
Auxiliary supply frequency	Rated Value ±1%

Input Voltage (Beta20P / Beta40P)	
Nominal input voltage (AC RMS)	Phase -Neutral 290VL-N Line-Line 500V L-L
Max continuous input voltage	120% of rated value
Nominal input voltage burden	< 0.3 VA approx.per phase.
System PT secondary values	For Single Phase DPM- 60VLN to 290VLN programmable on site & for Three Phase DPM- 100VLL to 500VLL programmable on site.
System PT primary values	For Single Phase DPM- 60VLN to 999kVLN programmable on site & for Three Phase DPM- 100VLL to 900kVLL programmable on site.

Input Current (Beta10P / Beta30P)	
Nominal input current	5A AC RMS
System CT secondary values	1A & 5A programmable on site.
System CT primary values	From 1A up to 999kA (for 1 or 5 Amp)
Max continuous input current	120% of rated value
Nominal input current burden	< 0.2 VA approx. per phase

Auxiliary Supply	
External Aux	40 V - 300V AC/DC (± 5 %)
Frequency range	45 to 65 Hz
VA burden	3 VA Approx.

Overload Withstand	
Voltage	2 x rated value for 1 second, repeated 10 times at 10 second intervals
Current	20x rated value for 1 second, repeated 5 times at 5 min intervals

Influence of Variations	
Temperature coefficient	0.025% /°C for Voltage
	0.05% /°C for Current

Operating Measuring Ranges	
Voltage Range	10... 120% of rated value
Current Range	10 ... 120% of rated value
Frequency	45...65 Hz

Display update rate	
Response time to step input	1 sec approx.

Enclosure	
Front	IP 50
Back	IP 20

Safety	
Pollution degree	2
Installation category	III
High voltage taste	3.3 kV AC, 50Hz for 1 minute between Aux. and measuring inputs

Environmental	
Operating temperature	0°C to + 50°C
Storage temperature	-25°C to +70°C
Relative humidity	0... 95% non condensing
Warm up time	Minimum 3 minute
Shock	15g in 3 planes
Vibration	10... 55 Hz, 0.15mm amplitude

Dimensions and Weights	
a) 96x96 DPM	
Bezel size	96 mm x 96 mm DI N 43 718.
Panel cut-out	92 ^{+0.8} mm x 92 ^{+ 0.8} mm.
Overall depth	55 mm.
Weight	310 gm. Approx.
b) 48x96 DPM	
Bezel size	96 mm x 48 mm DI N 43 718
Panel cut-out	92 + 0.8 mm x 43.5 + 0.6 mm.
Overall depth	68 mm.
Weight	250 gm. Approx.

Applicable Standards	
EMC	IEC 61326-1: 2005
Safety	IEC 61010-1-2001, Permanently connected use
IP for water & dust	IEC60529

Parameters measured and displayed

A) Beta 40P		B) Beta 30P	
Network type	Displayed Parameter	Network type	Displayed Parameter
1) 3 Phase 4 wire	a. Phase -Neutral Voltage VR	1) 3 Phase 4 wire and 3 Phase 3 Wire	a. Phase Current AR
	b. Phase -Neutral Voltage VY		b. Phase Current AY
	c. Phase -Neutral Voltage VB		c. Phase Current AB
d. Line-Line Voltage VRY	d. System Current A		
e. Line-Line Voltage VYB	e. Max. system Current A		
f. Line-Line Voltage VBR	f. Min. system Current A		
2) 3 Phase 3 wire	g. System Voltage V	2) 1 Phase 2 wire	a. Phase Current A
3) 1 Phase 2 wire	h. Max. system voltage V		e. Max. Phase Current A
	i. Min. system voltage V		f. Min. Phase Current A
	a. Line-Line Voltage VRY		
	b. Line-Line Voltage VYB		
	c. Line-Line Voltage VBR		
	d. System Voltage V		
	e. Max. system voltage V		
	f. Min. system voltage V		
	a. Phase -Neutral Voltage V		
	b. Max voltage V		
	c. Min voltage V		

Connection

A) For 96x96 DPM BETA 40P

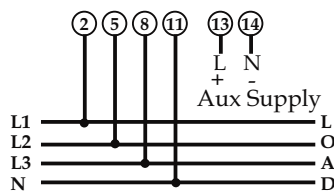

3PH - 4 Wire Network

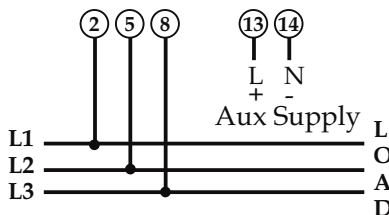

3PH - 3 Wire Network

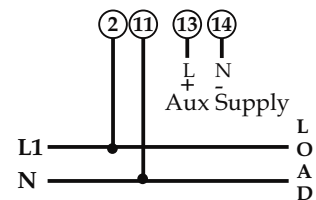

1PH Network

For 96x96 DPM BETA 30P

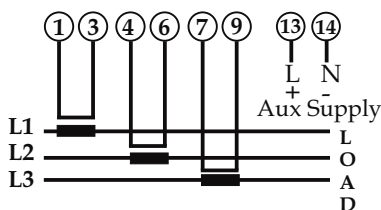

3PH - 4 Wire Network

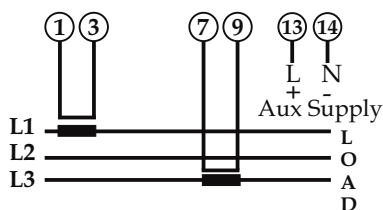

3PH - 3 Wire Network

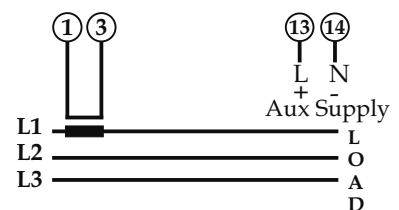

1PH Network

Connection

For 96x96 DPM Beta 20P

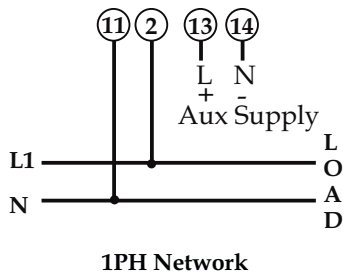

For 96x96 DPM Beta 10P

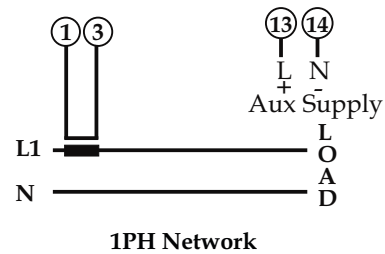

*Note: For Measurement of parameters in Beta 40P DPM Voltage must be present between terminal 2 & 11 for single phase or 3 phase 4 wire network and between terminal 2 & 5 or 2 & 8 for 3 phase 3 wire network. And for Beta 30 PDDM current must be present between terminal 1 & 3 for 3 phase 4 wire or 3 phase 3 wire or single phase network.

B) For 48x96 DPM Beta 40 P

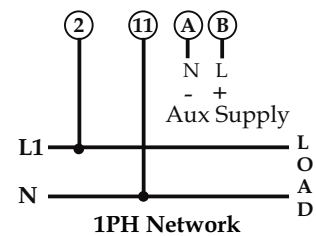
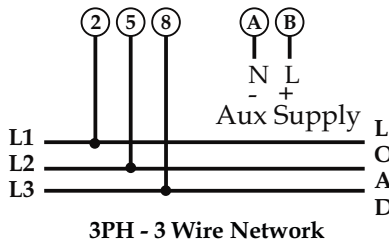
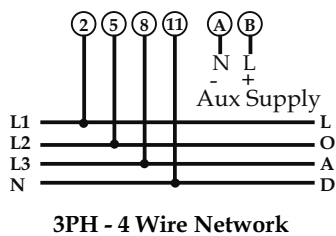

For 48x96 DPM Beta 30 P

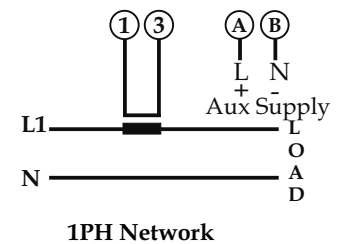
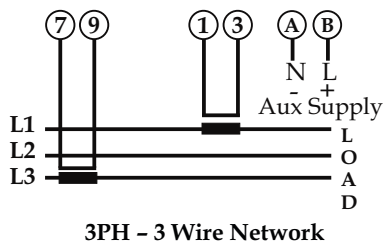
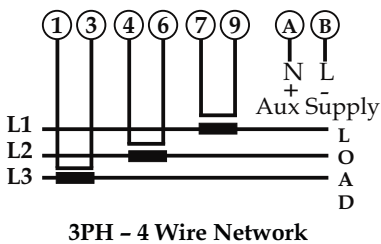

For 48x96 DPM Beta 20P

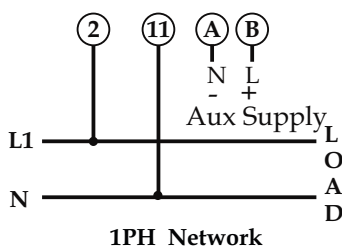

For 96x96 DPM Beta 10P

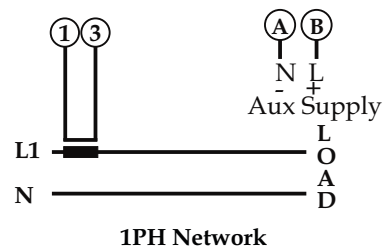

*Note: For Measurement of parameters in Beta 40P LD DPM Voltage must be present between terminal 1 & 6 for single phase or 3 phase 4 wire network and between terminal 1 & 3 or 1 & 5 for 3 phase 3 wire network. And for Beta 30P LD DPM current must be present between terminal 5 & 6 for 3 phase 4 wire or 3 phase 3 wire or single phase network.

Installation

Easy Clip in Installation on Panel for 96 x 96 size

Easy Clip-in mounting for
96x96 size

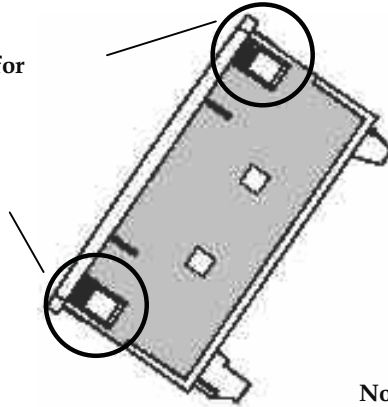

No need of swivel screws

A) For 96x96 DPM

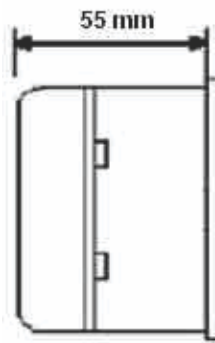
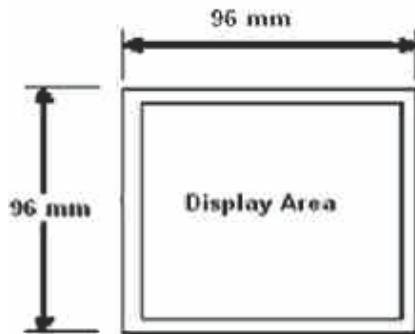

Mounting Position

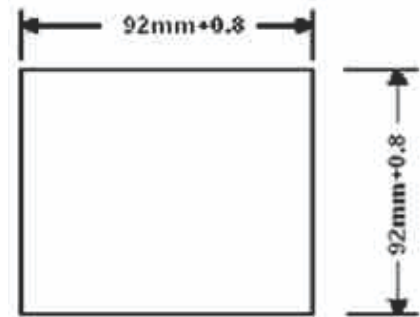

Installation Cutout

B) For 48x96 DPM

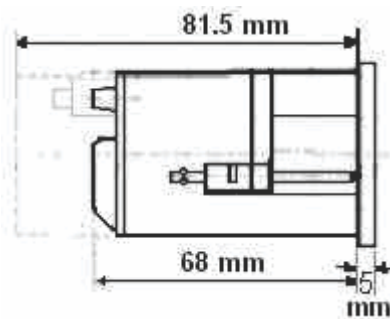
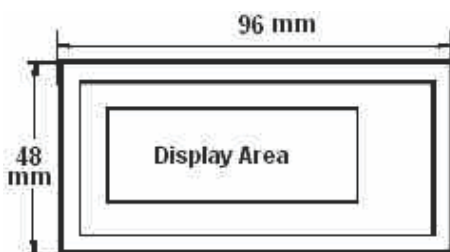

Mounting Position

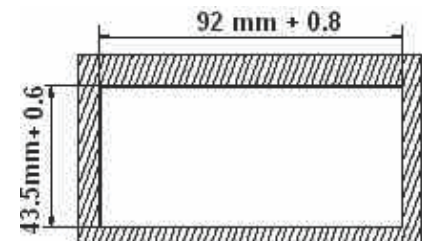

Installation Cutout

Ordering information

Product Code	BT14-	X	X	X	X	XX	X	X	00000
Size	48X96	E							
	96X96	G							
System Type	1P		1						
	3P		3						
Input Type	AC Voltmeter ACV			V					
	AC Ammeter ACI			K					
Display Size	14mm				1				
	20mm				2				
Input Range	5/1A					81			
	60-290LN					4A			
	60-600LN					4B			
	120-600LN					4C			
	100-500LL					4D			
Power Supply	40-300U						L		
IP Protection	W/O IP Protection							0	
	With IP Protection							1	