



# ADDERView™ Secure AVS-4128

User Guide



## Introduction

Welcome .....	2
Free-Flow .....	2
Features .....	2
Tamper-evident labels.....	3
Technical specifications .....	3
Supplied items .....	4
Optional extras.....	5

## Installation

Connections .....	6
Computer connections.....	7
Console connections.....	8
Power connection .....	9

## Configuration

Terminal mode .....	10
Creating a new admin account.....	11
Changing an admin account password.....	11
Changing channel button indicator colors .....	11
Performing a factory reset .....	12
Changing the hotkeys .....	12
Channel names and security levels.....	12

## Operation

Front panel channel switching.....	13
Hotkey channel switching.....	13
Free-Flow .....	13
Guard mode .....	14
Audio hold .....	14
Status display .....	14
Channel indications.....	14

## Further information

Getting assistance .....	15
Appendix A - Terminal mode configuration .....	16
Appendix B - Alternative layouts .....	19
Default eight-host, single-head, dual-display layout .....	19
Default eight-host, single-head, single-display layout.....	19
Eight-host layout with top/bottom displays.....	19
One dual-head host plus six single-head hosts.....	19
Eight single-head hosts with additional fixed display .....	20
Four-host dual-head layout.....	20
Appendix C - Hotkey commands .....	21

## Index

# Introduction



## WELCOME

Thank you for choosing the ADDERView™ AVS-4128 secure switch for sharing single or dual head video, USB keyboard and mouse, plus analog audio between up to eight host computers spanning multiple security classification levels. Video resolutions up to 3840 x 2160 @ 60Hz are supported and all video connections can be DisplayPort™ or HDMI®. The standard configuration allows the single-head outputs of any two hosts to be displayed on the dual video displays, in any order, with keyboard and mouse focus being switchable between them:

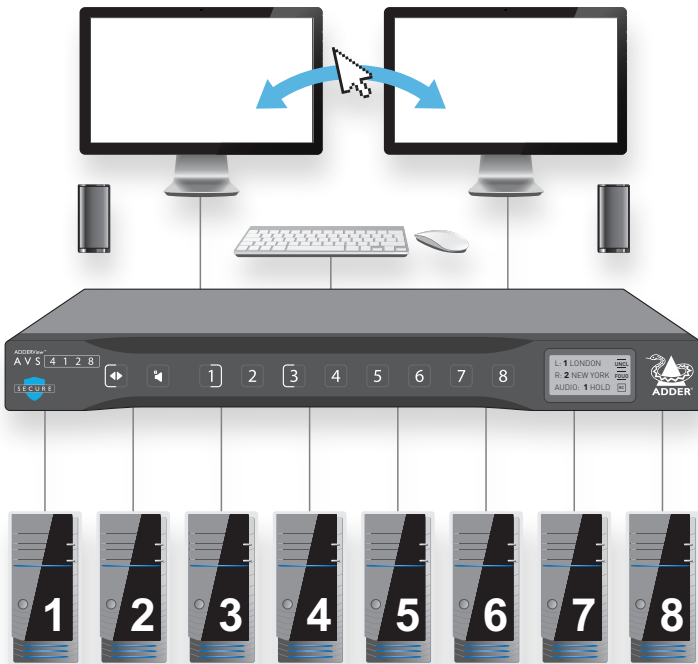

Alternative modes also support dual-head host connections, see “Appendix B - Alternative layouts” on page 19.

## Free-Flow

To simplify switching the keyboard and mouse between the hosts currently outputting to the two video displays, you can use the Free-Flow feature (see page 13). When enabled, keyboard and mouse focus follows the mouse as it moves across monitor edges.

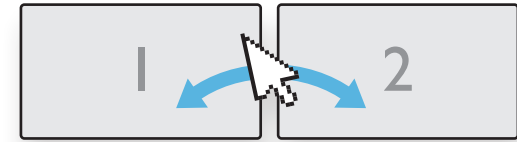

## Features

- Uni-directional keyboard, video, mouse and audio data paths prevent any potential information leakage through shared peripherals.
- No shared memory between channels: The keyboard and mouse processor is powered down and reset at each switchover to thwart shared data leakages.
- Automatic switching of keyboard and mouse focus between currently selected host computers (configurable *Free-Flow* mode). Simply move the mouse between displays.
- Clear channel identification to reduce the chances of operator error by displaying a user defined name and security classification for each channel on the status display. The color of the channel indicators may also be configured to reflect the security classification.
- Hardware anti-tampering: Holographic anti-tampering labels protect the product's enclosure, providing a clear visual indication if it has been opened or compromised.
- Restricted USB function: The USB ports will only accept HID (Human Interface Devices), such as keyboards and mice.
- There is no access to the product's firmware or memory through any port. Firmware is permanently stored in non-reprogrammable Read Only Memory (ROM) to prevent modification. Firmware integrity is verified through a self-test procedure during power up. Detection of a critical failure disables the device and provides a clear visual indication to the user.

## Safety

Please refer to the safety booklet provided in the box before use of this product.

INSTALLATION

CONFIGURATION

OPERATION

FURTHER INFORMATION

INDEX

## TAMPER-EVIDENT LABELS

The secure switch models and also the smart card reader use holographic tamper evident labels to provide visual indications in case of an enclosure intrusion attempt. When opening product packaging inspect the tampering evident labels.

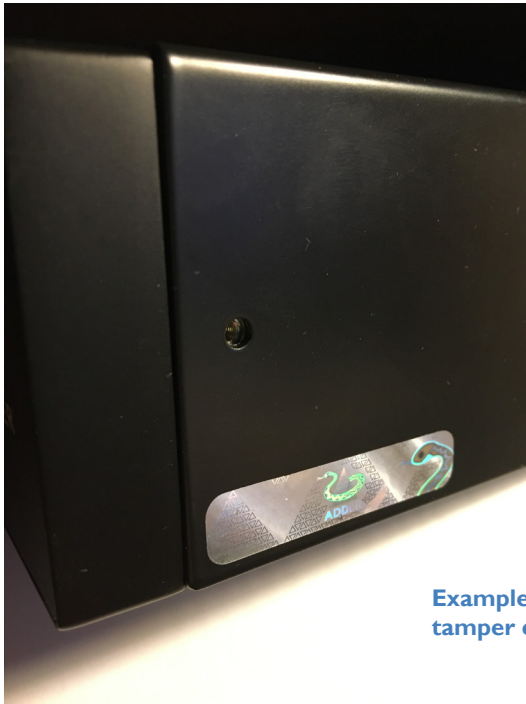

**Example of a holographic tamper evident label**

If for any reason one or more tamper-evident label is missing, appears disrupted, or looks different than the example shown here, please call Technical Support and avoid using that product.

## TECHNICAL SPECIFICATIONS

### Approvals / Compliance

CE, FCC class A, TUV US & Canada

NIAP PP 4.0 Certified for Peripheral Sharing Devices (PSD)

### Video resolutions

Up to 3840 x 2160 @ 60 Hz.

### Software compatibility

Windows, Linux, Mac host computer OS's

USB HID, including touchscreens compliant with Microsoft® Digitizer.

### Console connections

2x DisplayPort™/HDMI®,

2x USB type A

1x Audio (3.5mm)

RJ12 for remote control

### Computer connections

8x DisplayPort™/HDMI®,

8x USB type B

8x Audio 3.5mm

### Front panel

8x channel selection buttons with dual status indicators

1x channel focus button with status indicator

1x Audio hold button with status indicator

E-paper for status display (212 x 104)

### Physical design

Robust metal construction

17.48"/444mm(w), 1.73"/44mm(h), 6.1"/155mm(d) 2.6kg/5.73 lbs

### Power supply

100 - 240V AC, 47/63Hz

12V DC 30W output from power supply unit

### Environmental

Operating temp: 32°F to 104°F (0°C to 40°C)

Storage temp: -4°F to 140°F (-20°C to 60°C)

Humidity: 0-80% RH, non-condensing

# SUPPLIED ITEMS

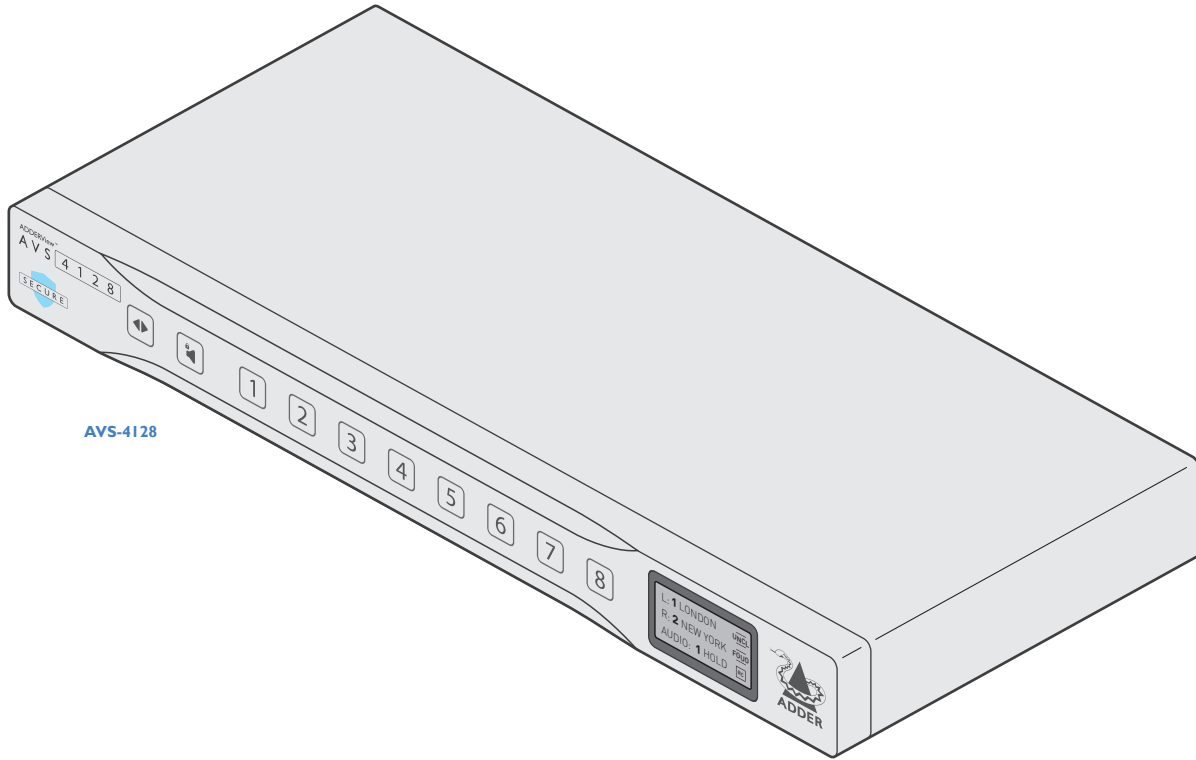

AVS-4128

Universal power adapter with locking connector

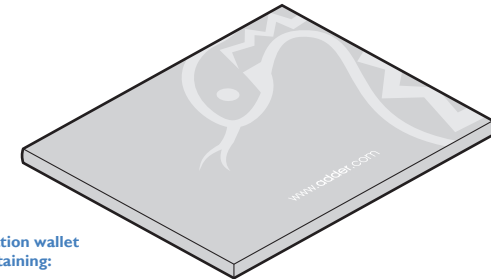
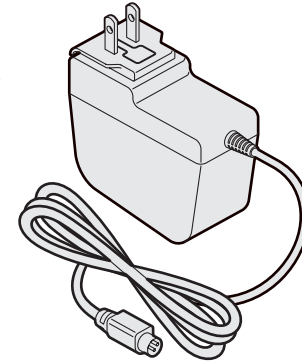

Information wallet containing:

- Four self-adhesive rubber feet
- Quick start guide
- Safety document

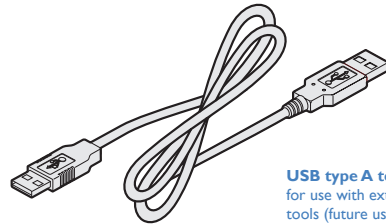

USB type A to type A cable for use with external configuration tools (future use)

INSTALLATION

CONFIGURATION

OPERATION

FURTHER INFORMATION

INDEX

# OPTIONAL EXTRAS

**19" rack-mount kit**  
Part number: RMK14

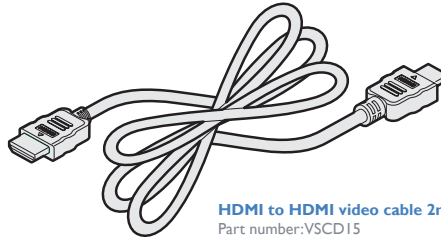
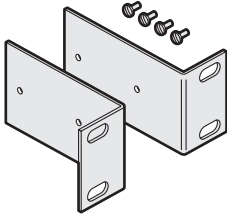

**HDMI to HDMI video cable 2m**  
Part number:VSCD15

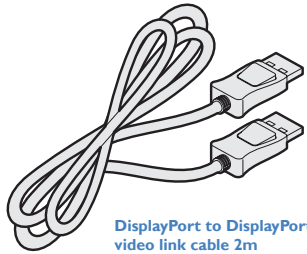

**DisplayPort to DisplayPort video link cable 2m**  
Part number:VSCD10a

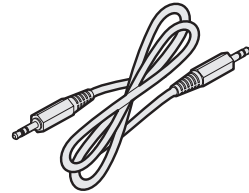

**Audio cable 2m (3.5mm stereo jacks)**  
Part number:VSC22

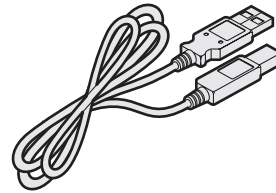

**USB cable 2m (type A to B)**  
Part number:VSC24

## CONNECTIONS

All connections are made at the rear panel. Use only approved shielded cables, particularly for the video connections. Ensure that all connections are made before applying power.

Suitable for installation in Information Technology Rooms in accordance with Article 645 of the National Electrical Code and NFPA 75.

Peut être installé dans des salles de matériel de traitement de l'information conformément à l'article 645 du National Electrical Code et à la NFPA 75.

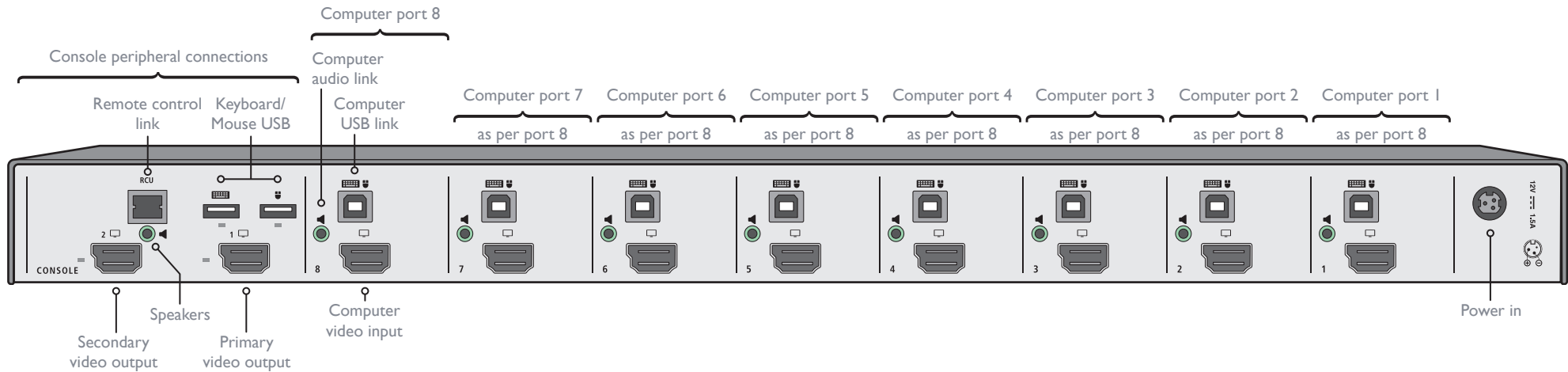

### Console port indications

#### Video LEDs

- Off - No EDID
- Flashing - Read in progress
- On - EDID received

#### USB LEDs

- Off - No device detected
- Flashing - Device rejected
- On - Device approved

*Note: Units are shipped with a blanking plug inserted into each combined video port, leaving only the HDMI connections open. If you need to use DisplayPort connections, simply remove the blanking plugs from the required ports.*

## Computer connections

The secure switch has eight computer ports, each of which consists of: one video link, a USB link and an audio connection.

The switch supports alternative ways of connecting and configuring computers and peripherals to allow slightly different modes of operation. See “Appendix B - Alternative layouts” on page 19.

*Note: Video resolutions up to 3840 x 2160 @ 60 Hz are supported.*

### To make connections to each computer port

- 1 Attach a cable between the video connector (DisplayPort® or HDMI™) and the primary video output connector on the computer.

DisplayPort® video connection to computer

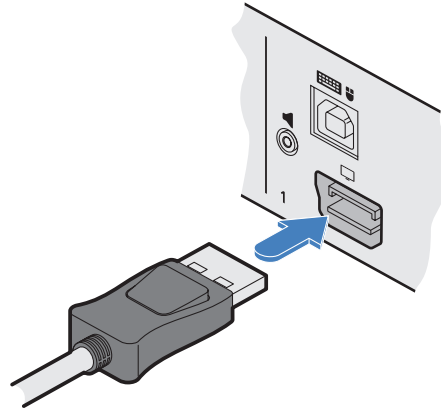

HDMI™ video connection to computer

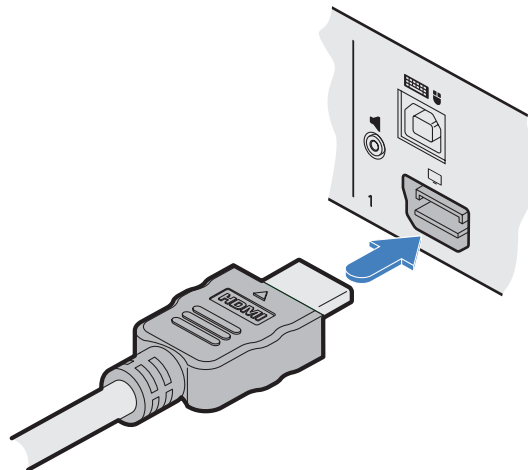

- 2 Insert a USB (type A to type B) cable between the USB socket and a vacant USB port on the computer.

USB connection to computer

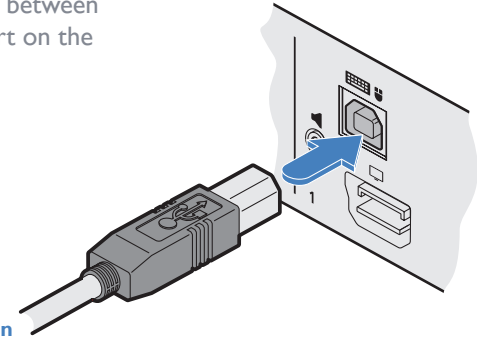

- 3 Insert a 3.5mm audio cable between the audio input socket and the speaker output on the computer.

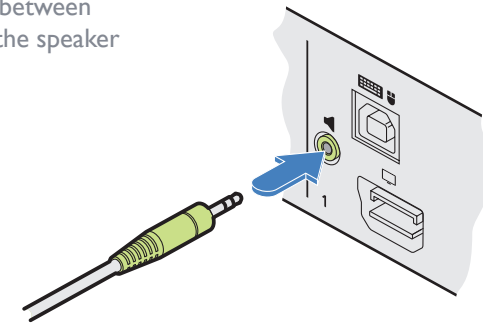



## Console connections

The video display(s), keyboard, mouse and speakers are attached to the various connectors on the rear panel that constitute the console port.

The switch supports alternative ways of connecting and configuring computers and peripherals to allow slightly different modes of operation. See “Appendix B - Alternative layouts” on page 19.

*Note: Video resolutions up to 3840 x 2160 @ 60 Hz are supported.*

### To make console connections

- 1 Attach the primary video display (DisplayPort® or HDMI™) to video connector 1.
- 2 Where a secondary video display (DisplayPort® or HDMI™) is also to be used, repeat the previous step for the video connector 2.

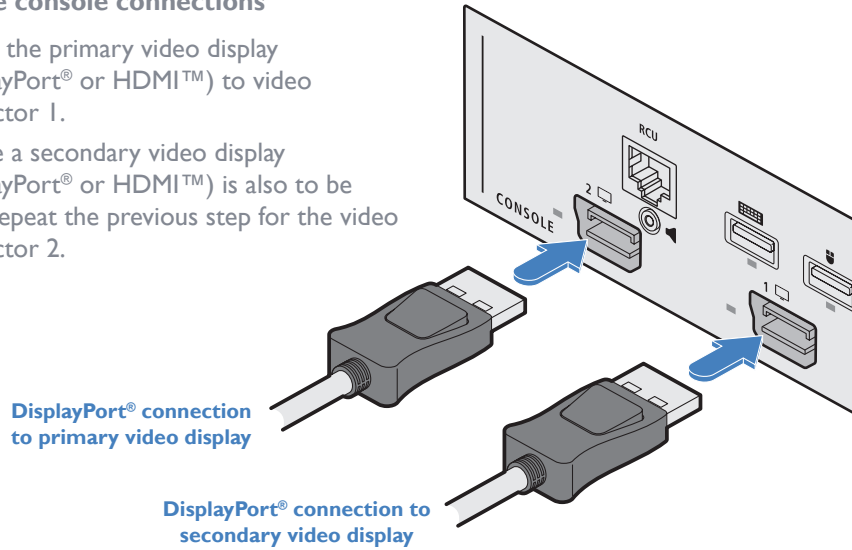

- 3 Connect the USB leads from the console mouse and keyboard to the two sockets on the rear panel.

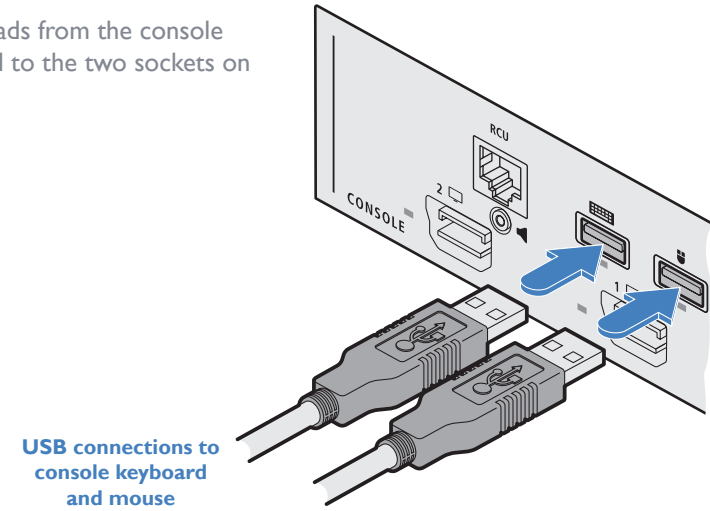

- 4 Insert the lead from the console speakers into the 3.5mm audio output socket on the rear panel.

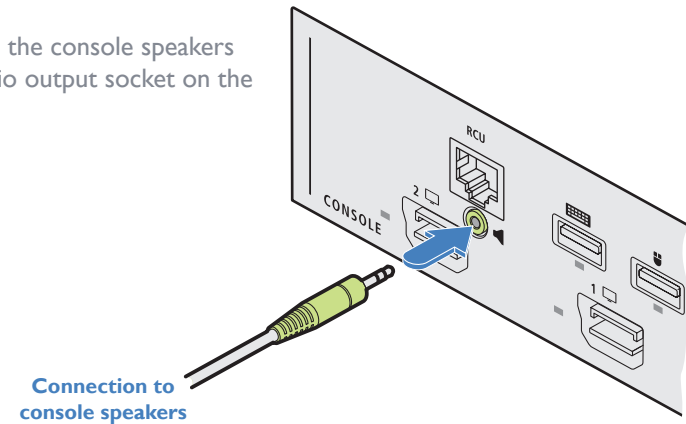
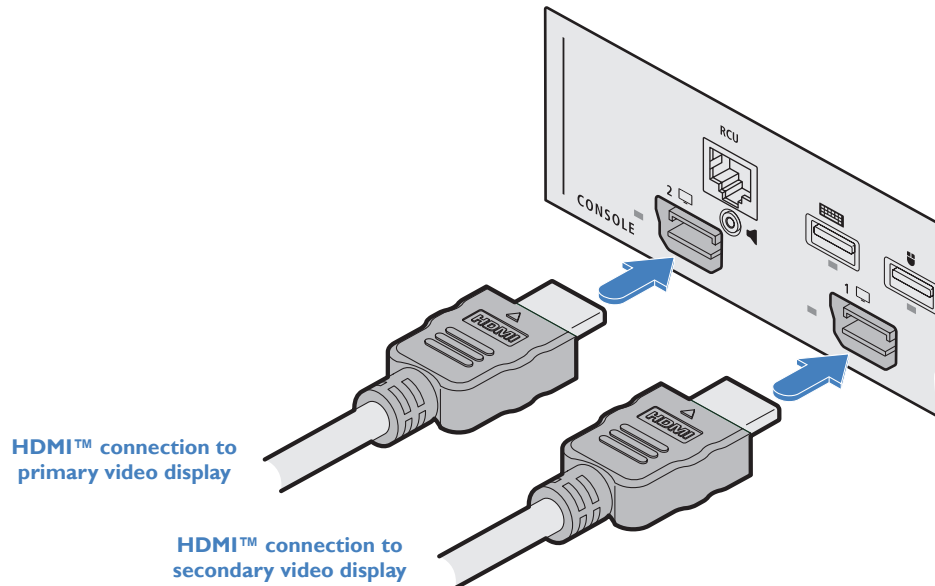

## Power connection

**IMPORTANT:** Ensure that the video displays connected to the secure switch are powered on before applying power to the secure switch itself.

The supplied power adapter uses a locking-type plug to help prevent accidental disconnection from the secure switch; please follow the instructions below when disconnecting the power adapter.

### To connect the power adapter

- 1 Attach the output plug of the supplied power adapter to the power input socket on the right side of the rear panel. As you insert the plug, pull back slightly on the outer body to assist the locking mechanism until the plug is fully inserted.

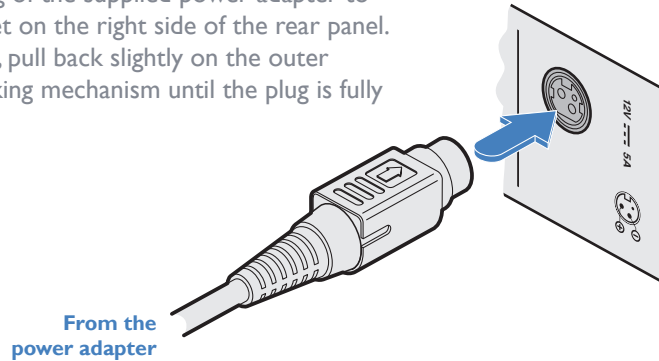

- 2 Attach the appropriate country-specific plug to the power adapter body and insert it into a nearby mains outlet.

### To disconnect the power adapter

- 1 Isolate the power adapter from the mains supply.
- 2 Grasp the outer body of the power adapter plug where it connects with the node.
- 3 Gently pull the body of the outer plug away from the node. As the body of the plug slides back, it will release from the socket and you can fully withdraw the whole plug.

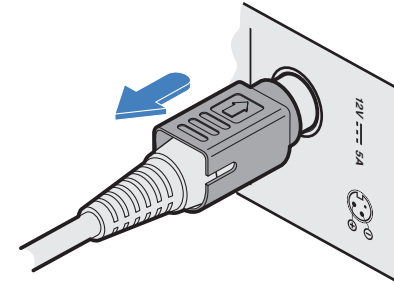

**IMPORTANT:** Please read and adhere to the electrical safety information given within the supplied safety guide. In particular, do not use an unearthed power socket or extension cable.

# Configuration



The secure switch has an internal Terminal Mode, which requires you to run a text editor application (such as Windows Notepad, Word, etc.) on the computer that is connected to channel 1. As you type commands on the console keyboard, the secure switch will use the text editor application to communicate with you.

Notes: The Terminal Mode assumes use of a US keyboard. Always use the number buttons above the letters (not the numeric keypad). After three failed login attempts, terminal mode will be locked. Cycle the device power and try again.

## To enter Terminal Mode

1 Switch to computer 1 and ensure that a text editor application (such as Windows Notepad, Word, etc.) is running and that the cursor is active within it.

2 On the console keyboard, enter the following in succession:

- **Left Ctrl** then **Right Ctrl** then **t** (upper or lower case is accepted)

Within the text editor application, the secure switch will respond with:  
*secure switch configuration, please enter admin name*

3 Type the default admin name: **admin1234** (or an alternative if it has been changed) and press Enter. If correct, the secure switch will respond with:

*[sc]please enter the password...*

4 Type the default password: **Adder123%** and press Enter. Note: A US keyboard is assumed, so for other countries the last password character should be typed as 'shift 5'.

- **IMPORTANT: On first access, you will be compelled to change the default password.**

If the password is correct, the secure switch will now list the top level options:

*authentication succeeded. please select operation...*

- 0 – asset management
- 1 – firmware versions
- 3 – configure sc (system controller)
- 4 – account management
- 5 – reset to factory defaults
- 6 – logs and events
- 7 – configure peripheral devices
- 8 – exit terminal mode
- 9 – power cycle the kvm

5 On the console keyboard, enter the number of the required option. See map right >

## To exit terminal mode

- To exit from the menu but still remain logged in: Press option **8** at the top level.
- To log out completely from the menu: Press option **9** at the top level.

## Terminal mode map

This map shows the top level options (0 to 9) and the second level options within each - certain options also have third level menu items. Note: Every sub-level group also includes the options: **8** - back (to return to the top level menu) and also **9** - exit terminal mode.

- 0 – asset management.....see page 16
  - 1 – use standard descriptor as asset container
  - 2 – use custom descriptor as asset container
  - 3 – enter new asset tag
  - 4 – show current asset tag
  - 5 – apply asset tag to de
- 1 – firmware versions.....see page 16
  - 1 – de version
  - 2 – sc version
  - 3 – vc version
  - 4 – fp version
- 3 – configure sc.....see page 16
  - 1 – enter desktop configuration (not used on these models)
  - 2 – enter mouse speed [0-32][default=5]
  - 3 – upload configuration from the host
  - 4 – use ctrl key as shortcut prefix
  - 5 – use alt key as shortcut prefix
  - 6 – guard mode configuration
  - 7 – fp configuration
- 4 – account management.....see page 17
  - 1 – change password
  - 2 – create admin account
  - 3 – delete all accounts
- 5 – reset to factory defaults.....see page 12
- 6 – logs and events.....see page 17
  - 1 – show otp log
  - 2 – show critical ram log
  - 3 – show non-critical ram log
- 7 – configure peripheral devices.....see page 18
  - 1 – toggle touch screen support
  - 2 – toggle consumer control support
  - 3 – configure absolute mouse support
  - 4 – toggle copy/paste support
- 8 – exit terminal mode
- 9 – power cycle the kvm

For details of each option, please refer to Appendix A. See page 16.

## Creating a new admin account

Each switch can have up to nine admin accounts in addition to the default account. You can create a new admin account at any time.

### To create a new admin account

- 1 Enter terminal mode (see page 10).
- 2 Choose option **4 - account management**.
- 3 Choose option **2 - create admin account**.
- 4 Enter a username for your new admin account and press Enter. *Note: Admin usernames must be 5 to 11 characters and must contain a mix of upper and lowercase characters.*
- 5 Repeat the new admin account username and press Enter.
- 6 Enter a password for the new account. *Note: Passwords must be 8 to 15 characters in length and must contain a mix of at least one each of the following: Uppercase letters, lowercase letters, digits 0 to 9 and any of these special characters: “!@#%&\*()-\_”*
- 7 Repeat the password and press Enter.  
If the two passwords match you will be returned to the top level menu.
- 8 Once you are finished with terminal mode, don't forget to log out completely by choosing option **9** from the top level menu.

### To delete all accounts

- 1 Enter terminal mode (see page 10).
- 2 Choose option **4 - account management**.
- 3 Choose option **3 - delete all accounts**.  
All accounts except the default admin account will be removed.

## Changing an admin account password

You can change the password for any admin account by first logging in to the account you wish to change.

### To change the access password

- 1 Log in to the admin account that you wish to change and enter terminal mode (see page 10).
- 2 Choose option **4 - account management**.
- 3 Choose option **1 - change password**.
- 4 Enter a new password for the chosen admin account and press Enter. *Note: Passwords must be 8 to 15 characters in length and must contain a mix of at least one each of the following: Uppercase letters, lowercase letters, digits 0 to 9 and any of these special characters: “!@#%&\*()-\_”*
- 5 Repeat the new password and press Enter.  
If the two passwords match you will be returned to the top level menu.
- 6 Once you are finished with terminal mode, don't forget to log out completely by choosing option **9** from the top level menu.

## Changing channel button indicator colors

On the front panel there is a numbered button for every channel and each button has a left and right indicator (for the primary and secondary displays). All indicators use a white colour by default, however, to assist with visual feedback for the operator you can change the highlight color for each side of button that will be shown as each channel is selected.

### To change the button indicator colors

- 1 Enter terminal mode (see page 10).
- 2 Choose option **3 - configure sc**.
- 3 Choose option **7 - fp configuration**.
- 4 Choose option **2 - select colors for channels**.
- 5 Type the number of the channel whose color you wish to change. The secure switch will list all of the color options for your chosen channel indicator:
  - r – red
  - o – orange
  - y – yellow
  - w – white
  - m – mint
  - g – green
  - c – cyan
  - b – blue
  - p – purple
  - t – magenta
- 6 Type the letter representing the required color. The selected color will be applied to the channel.
- 7 Optionally, enable upload mode to allow the RGB configuration tool to upload. Choose option **1 - Upload FP configuration from a host**. Reserved for future use.
- 8 Choose option **8** to go up one menu level. Then:
  - To change another indicator, choose option **7** and repeat steps 4 to 6 above.
  - To return to the top menu level, choose option **8** again.
  - Once you are finished with terminal mode, don't forget to log out completely by choosing option **9** from the top level menu.

*Note: The chosen channel colors will also be shown on the optional remote control, when used.*

## Performing a factory reset

A factory reset will return most configuration options to their default settings. The default admin account will not be affected and neither will the contents of any logs.

### To perform a factory reset

- 1 Enter terminal mode (see page 10).
- 2 Choose option **5 - reset to factory defaults**.
  - The secure switch will immediately perform the reset operation and return to normal operation.
- You can also initiate a factory reset using **Left Ctrl then Left Ctrl then F11 then r** at any time.

## Changing the hotkeys

Certain operations on the secure switch, such as entering terminal mode, changing between mouse modes, etc, require you to press certain key combinations, known as hotkeys. By default, the left and right Ctrl keys are used, however, these can be changed to the left and right Alt keys, if required.

### To change the hotkeys

- 1 Enter terminal mode (see page 10).
- 2 Choose option **3 - configure sc**.
- 3 Choose the required option:
  - **4 - use ctrl key as shortcut prefix**, or
  - **5 - use alt key as shortcut prefix**.

The chosen hotkey (short cut prefix) will be confirmed within the on screen text editor.
- 4 Choose option **8** to go up one menu level. Then:
  - To return to the top menu level, choose option **8** again.
  - Once you are finished with terminal mode, don't forget to log out completely by choosing option **9** from the top level menu.

## Channel names and security levels

The front panel display screen clearly shows the currently selected channel number and name for the primary and secondary video displays, plus the audio channel source and hold status source. In addition, you can optionally choose to show a channel name and/or standard security level tag:



- Primary (Left): Channel number/name and security level tag
- Secondary (Right): Channel number/name and security level tag
- Audio channel and hold plus remote control status

*Note: The black arrow denotes which channel currently has keyboard/mouse focus*

### To enter/edit a channel name

- 1 Enter terminal mode (see page 10).
- 2 Choose option **3 - configure sc**.
- 3 Choose option **7 - fp configuration**.
- 4 Choose option **5 - enter channel names and security information**.
- 5 Choose option **2 - update channel name**.
- 6 Select a channel number (1 to 8).
- 7 Enter the required channel name (up to 8 characters) and press enter. *Note: To delete an existing channel name, delete all characters and press enter.*
- 8 Choose option **8** to go up one menu level. Then:
  - To return to the top menu level, choose option **8** again.
  - Once you are finished with terminal mode, don't forget to log out completely by choosing option **9** from the top level menu.

### To choose a security level tag

- 1 Follow steps 1 to 4 shown above.
- 2 Choose option **3 - update channel security**.
- 3 Select a channel number (1 to 8).
- 4 Select the security level tag for the chosen channel:

key	screen text	meaning
0	[blank]	Leaves the security field blank (default)
1	UNCL	Unclassified
2	FOUO	For Official Use Only
3	CONF	Confidential
4	SEC	Secret
5	TSEC	Top Secret
6	SCI	Top Secret SCI

- 5 Press Esc, then choose option **8** to go up one menu level. Then:
  - To return to the top menu level, choose option **8** again.
  - Once you are finished with terminal mode, don't forget to log out completely by choosing option **9** from the top level menu.

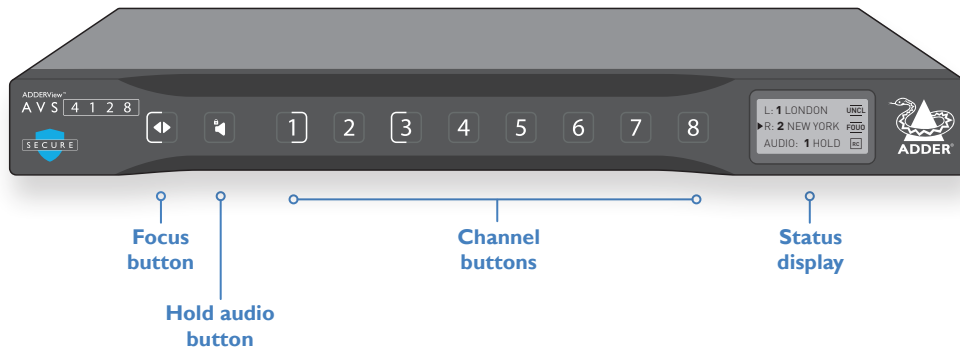

## Front panel channel switching

The button toggles the focus between the left and right video displays (and the host computers that they are connected to).

The button illuminates in two halves to represent the left and right video displays. When the right side of the button is lit, this means that the keyboard and mouse are connected to the host computer that is linked to the right video display. Pressing a channel button will cause the new channel to be output to the display that currently has focus.

Note: If you are using a single video display, leave the button lit on its left side.

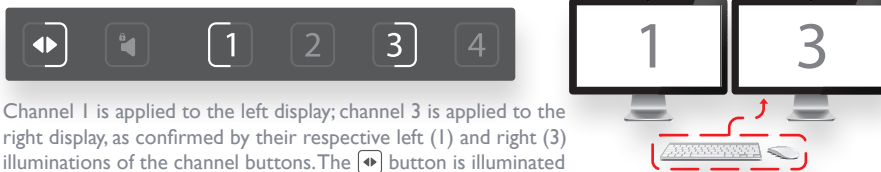

Channel 1 is applied to the left display; channel 3 is applied to the right display, as confirmed by their respective left (1) and right (3) illuminations of the channel buttons. The button is illuminated on its right side, meaning that the keyboard and mouse are currently linked to the host computer on channel 3. Any channel button pressed at this stage would connect that computer to the right display as well as the keyboard and mouse.

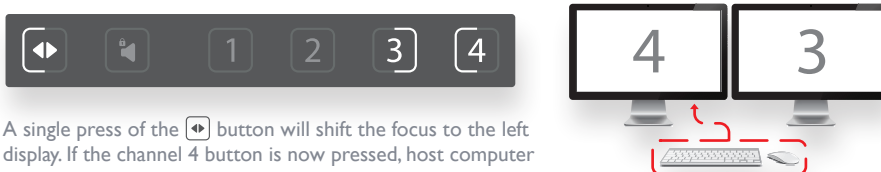

A single press of the button will shift the focus to the left display. If the channel 4 button is now pressed, host computer 4 will be connected to the left display (as well as to the keyboard and mouse). An optional press of the button will shift the keyboard and mouse back to the channel 3 computer, without affecting either of the video displays.

## Free-Flow

Adder Free-Flow allows you to automatically switch between host computers simply by moving the mouse across the edge of the screen. When enabled, keyboard and mouse focus follows the mouse as it moves across monitor edges. You'll notice that the focus button reflects the current cursor position.

Notes:

- When used with dual head displays connected to computers running older versions of Windows, it may require looping through the displays twice to effect a switch. The problem may be resolved by installing the Dual Monitor driver available from [Adder.com](http://Adder.com)
- Upon switching, the operator is advised to check the front panel display to confirm the currently selected channel.
- The Free-Flow feature is disabled by default and a factory reset will return it to a disabled state.

This feature requires the mouse to be used in absolute mode so that the switch can determine its exact position on each video display, rather than the default relative mode.

Note: Older versions of Linux do not support Absolute mode, so cannot be used with Free-Flow.

### To enable Free-Flow

- Select absolute mouse mode: Press **Left Ctrl** then **Left Ctrl** then **F11** then **c**

### To disable Free-Flow

- Select relative mouse mode: Press **Left Ctrl** then **Left Ctrl** then **F11** then **b**

## Guard mode

Once Free-Flow is enabled, whenever you wish to switch to another computer, simply hold down the **Left Ctrl** key on the console keyboard as you move the mouse



pointer from the boundary of one screen towards that of the next. The channel should change as the pointer crosses the boundary. The necessity to hold down the Left Ctrl key is called *Guard Mode* and is there to prevent accidental switching. If required, you can disable guard mode, as discussed on page 16.

## Audio hold

This front panel button (also replicated on the optional remote control unit) allows you to take the audio output from one computer while operating on another.



### To use audio hold

- 1 Use any of the switching methods to choose the computer whose audio you wish to hear.
- 2 Press the Audio Hold button, either on the secure switch front panel or on the optional remote control unit.
- 3 Switch to the computer that you wish to use.  
The audio feed to the speakers (attached to the secure switch) will continue to feed from the initially connected computer.

## Status display

The status display shows the current channel number, channel name (if configured), audio channel and hold status, plus security classification (if configured). It also indicates whether the switch is under remote control.

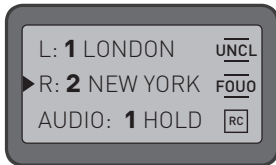

- Primary (Left): Channel number/name and security level tag
- Secondary (Right): Channel number/name and security level tag
- Audio channel and hold plus remote control status

*Note: The black arrow denotes which channel currently has keyboard/mouse focus*

The channel names and security classifications can be altered using Terminal mode - see “Appendix A - Terminal mode configuration” on page 16.

The RC symbol indicates that an external device is connected to the remote control port. Refer to the remote interface manual, MAN-000022 for details.

## Channel indications

You can optionally assign indicator colors to each computer channel so that each front panel button illuminates accordingly.

The channel indicator colors can be altered using Terminal mode - see “Appendix A - Terminal mode configuration” on page 16.

# Further information



This chapter contains a variety of information, including the following:

- Getting assistance - see right
- [Appendix A](#) - Configuration menu items
- [Appendix B](#) - Alternative layouts
- [Appendix C](#) - Hotkey commands

## GETTING ASSISTANCE

If you are still experiencing problems after checking the information contained within this guide, then please refer to the Support section of our website:

[www.adder.com](http://www.adder.com)

INSTALLATION

CONFIGURATION

OPERATION

FURTHER  
INFORMATION

INDEX



## Appendix A - Terminal mode configuration

This section lists the terminal mode options available within the secure switch. For details of how to access terminal mode, see page 10.

*Note: Every sub-level group also includes the options: 8 - back (to return to the top level menu) and also 9 - exit terminal mode.*

### asset management - [option 0 from the top level menu]

These options are deal with the USB name (descriptor) that the secure switch uses to identify itself to the connected computers. In order to avoid a standard descriptor being used across numerous computers, serving as a marker for potential attackers, use these options to enter a new custom tag (option 3), set it as the default (option 2) and send it to the attached computers (option 5). Once a descriptor is set, it will be sent to the computers at every power up.

#### 1 – use standard descriptor as asset container

Select this option to use the standard descriptor, which was defined during manufacture, when declaring itself to the connected computers.

#### 2 – use custom descriptor as asset container

Select this option to use the asset tag entered using option 3 (below) as the descriptor that is declared to the connected computers.

#### 3 – enter new asset tag

Use this option to enter a custom asset tag for the secure switch, when enabled using option 2 (above), which will then be reported to the connected computers at each power up or by using option 5 (below).

#### 4 – show current asset tag

Select this option to view the custom asset tag that is stored (if any).

#### 5 – apply asset tag to de

Select this option to send either the standard or custom descriptor (as determined by the selection of either options 1 or 2 above) to all of the connected computers.

### firmware versions - [option 1 from the top level menu]

These options display the firmware versions of the various primary components of the secure switch.

#### 1 – de version

Displays the firmware version for the desktop environment (interface).

#### 2 – sc version

Displays the firmware version for the main system controller.

#### 3 – vc version

Displays the firmware version for the video controller.

#### 4 – fp version

Displays the firmware version for the front panel controller.

### configure sc - [option 3 from the top level menu]

These system controller options deal with numerous aspects of secure switch configuration.

#### 1 – enter desktop configuration [0-40][default=0]

Not used on these models.

#### 2 – enter mouse speed [0-32][default=5]

Use this option to determine the speed of mouse movement.

#### 3 – upload configuration from the host

Reserved for Adder Support use only - Opens channels for kmc tool to upload a new KM config.

#### 4 – use ctrl key as shortcut prefix

Use this option to use the left and right Ctrl keys as the hotkeys for accessing terminal mode and invoking other features.

#### 5 – use alt key as shortcut prefix

Use this option to use the left and right Alt keys (the right Alt key is often marked as Alt Gr) as the hotkeys for accessing terminal mode and invoking other features.

#### 6 – guard mode configuration

To enable: choose option 1 - switch hosts with mouse and ctrl key pressed.

To disable: choose option 2 - switch hosts with ordinary mouse movements.

The chosen mode will be confirmed within the on screen text editor. Note: Guard mode is enabled by default and will be re-enabled when the switch is power cycled.

#### 7 – fp configuration

See next page

## configure sc - continued

### 7- fp configuration

#### 1 – upload fp configuration from a host

Allows the unit to communicate with the FP Config tool for defining the front panel configuration. Note: It is also possible to enter unit to upload mode with the Left Ctrl | Right Ctrl | L hotkey.

#### 2 – select colors for channels

Allows you to change the button indicator colors. See page 11.

#### 3 – select dimming

By default, the LEDs for unselected channels are off. This option allows them to be displayed dimmed, such that the user can see all of the channel colors.

#### 4 – enter screen cycles refresh [1-50][default=10]

The ePaper screen used on the front panel requires a full refresh after so many updates (cycles). This option allows the user to specify the cycles between screen refreshes.

#### 5 – enter channel names and security information (see page 12)

1 - display current (shows the current front panel configuration)

2 - update channel name (allows you to add/edit names for channels)

3 - update channel security (allows you to configure the security level tag):

- select a channel [1-8]
- select the security level tag for the chosen channel:

key	screen text	meaning
0	[blank]	Leaves the security field blank (default)
1	UNCL	Unclassified
2	FOUO	For Official Use Only
3	CONF	Confidential
4	SEC	Secret
5	TSEC	Top Secret
6	SCI	Top Secret SCI

- once selected, press esc to go back

## account management - [option 4 from the top level menu]

These options relate to the admin accounts and their passwords.

#### 1 – change password

Allows you to change the access password for any admin account. See page 11.

#### 2 – create admin account

Allows you to create a new admin account. See page 11.

#### 3 – delete all accounts

Deletes all admin accounts except the default one. See page 11.

## reset to factory defaults - [option 5 from the top level menu]

This option returns all settings to the factory defaults but does not change the admin username and password or the event logs. See page 12.

## logs and events - [option 6 from the top level menu]

These options are all related to system monitoring and the logs that are retained as a record of operational events.

#### 1 – show otp log

This (one time programmable) log stores up to 64 critical events in parallel with the critical ram log and the entries can never be deleted or overwritten. The 65th entry and beyond will only be written to the critical ram log.

#### 2 – show critical ram log

This log stores the date, time and username of events that are defined as critical, such as: self test failures, peripheral device rejection, tampering event, factory resets and admin password changes. It stores up to 64 events in a cyclic way (overwrites the new events instead of the oldest ones). This log is not affected by a factory reset.

#### 3 – show non-critical ram log

This log stores records of non-critical events such as power ups, peripheral device acceptance, simple configuration change, Admin logins, user add/delete, password changes or password lock, etc. It retains 128 of the latest events and overwrites the oldest entries when it is full. This log is not affected by a factory reset.

## configure peripheral devices - [option 7 from the top level menu]

These options relate to connected peripheral devices. Changes to these settings require up to ten seconds to become active.

### 1 – toggle touch screen support

*Enable support for touch screen input devices. These must adhere to the Microsoft Digitizer standard.*

### 2 – toggle consumer control support

*Enable support for consumer report keyboards.*

### 3 – configure absolute mouse support

*Allows you to choose whether the connected console mouse operates in relative mode (the default manner) or absolute mode. The latter is required if you wish to use the Free-Flow mode to change between computers. See page 14. Note: Absolute mode is not supported on older versions of Linux.*

### 4 – toggle copy/paste support

*Copy and paste are permanently disabled on secure switches.*

## Appendix B - Alternative layouts

This section lists the various ways that host computers and video displays can be arranged on the switch. The keypresses that enable each mode need only be enacted once to set the configuration and will persist through complete power cycles. A factory reset operation will return to the *Standard eight-host single-head layout*.

*Note that each layout uses Absolute mouse mode. If the uses changes to Relative mouse mode, then the unit will be returned to the default eight-host single-head layout.*

Other bespoke layouts can be created for you by Adder Professional Services on request.

### Default eight-host, single-head, dual-display layout

The standard layout allows you to control up to eight host computers and view their video outputs on either single or dual displays. When dual displays are used, each display can show the video output from any of the connected host computers, as selected either by front panel switches or keyboard hotkeys (see Appendix C on page 21). If Free-Flow is used for automated switching of focus between the two displays, they will be assumed to be arranged side-by-side, with the primary display on the left side.

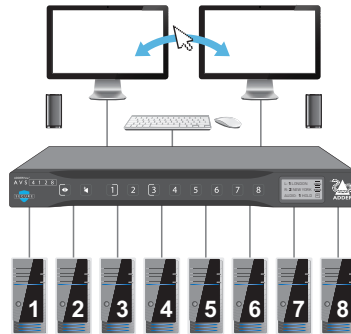

#### To configure this layout

If the switch has been used in any other configuration, you can restore the standard layout with the following keypress sequence:

- **Left Ctrl then Left Ctrl then F11 then F1** (Note: F11 and F1 are function keys)

### Eight-host, single-head, single-display layout

This variation is similar to the standard layout above, except that only a single video display is used.

Notes:

- The button should remain with its left indicator lit.
- Free-Flow is not enabled.

#### To configure this layout

If the switch has been used in any other configuration, you can restore the standard layout with the following keypress sequence:

- **Left Ctrl then Left Ctrl then F11 then m** (Note: F11 is a function key)

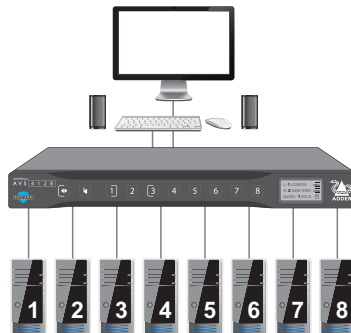

### Eight-host layout with top/bottom displays

This layout operates as per the standard 8-host arrangement except that the displays are treated as being arranged one above the other for the purposes of Free-Flow switching (with the primary display at the top).

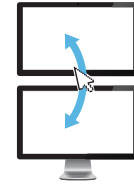

#### To configure this layout

Use the following keypress sequence:

- **Left Ctrl then Left Ctrl then F11 then F2** (Note: F11 and F2 are function keys)

### One dual-head host plus six single-head hosts

This layout provides hybrid dual-head and single-head operation which permits one host to present two video channels while the other six supply a single video channel each. When channel 1 is chosen, its dual outputs will be shown on the two displays. When any other channel is chosen (except channel 2, which is not used), its output will be sent to either the left or right display, as determined by the current setting of the button (see page 13).

If Free-Flow is used for automated switching of focus between the two displays, they will be assumed to be arranged side-by-side, with the primary display on the left side.

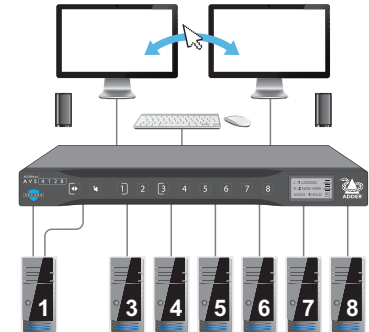

#### To configure this layout

Use the following keypress sequence:

- **Left Ctrl then Left Ctrl then F11 then F3** (Note: F11 and F3 are function keys)

continued

## Eight single-head hosts with additional fixed display

This layout is particularly useful if an operator needs to continually monitor a critical source while also switching between other host computers. The first host computer provides its primary video output directly to the left-most of the three displays. Its secondary video output is connected to port 1 while up to seven other single-head hosts are connected to the remaining ports.

The primary output of host 1 is permanently displayed. Switching between all other channels proceeds as normal (see page 13).

If Free-Flow is used for automated switching of focus between the three displays, they will be assumed to be arranged side-by-side, with the secondary display on the far right side. *Note: The externally connected monitor must have the same native resolution of the primary display that is connected directly to the switch.*

### To configure this layout

Use the following keypress sequence:

- **Left Ctrl then Left Ctrl then F11 then F7** (Note: F11 and F7 are function keys)

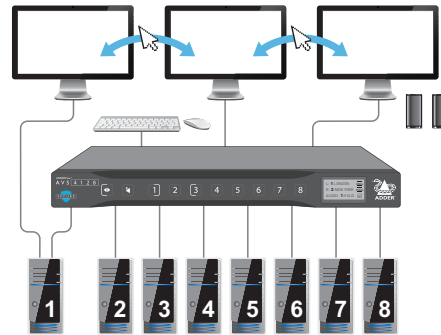

## Four-host dual-head layout

This layout allows you to control up to four host computers and view their video outputs on dual displays. Each host is connected to two ports: host 1 to ports 1 and 2, host 2 to ports 3 and 4, and so on. On the front panel only four of the channel buttons are used: button 1 selects channels 1 and 2 (host 1), Button 3 selects channels 3 and 4 (host 2), etc.

When moving the cursor between the two displays, they will be assumed to be arranged side-by-side, with the primary display on the left side.

### To configure this layout

Use the following keypress sequence:

- **Left Ctrl then Left Ctrl then F11 then d** (Note: F11 is a function key)

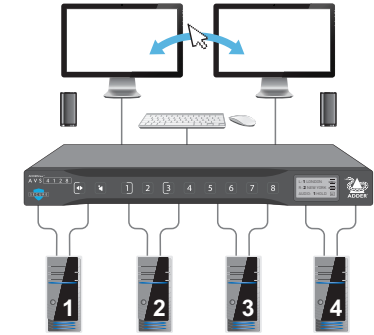

## Appendix C - Hotkey commands

This section provides a summary of hotkey commands used on the secure switch. In each case, press and release the listed keyboard buttons in the order shown.

Notes:

- No distinction is made between upper and lower case characters.
- The sequences shown here use the syntax: **L CTRL** | **L CTRL** | **FII** | **m** which means: **Left Ctrl** then **Left Ctrl** then **FII** then **m** (where **FII** is a function key)

Toggle between mouse modes	(Absolute) (Relative)	L CTRL   L CTRL   F11   c L CTRL   L CTRL   F11   b
Alter mouse speed	(Increase) (Decrease)	L CTRL   L CTRL   F11   + L CTRL   L CTRL   F11   -
System reset to factory defaults		L CTRL   L CTRL   F11   r
Enter Terminal mode		L CTRL   R CTRL   t
Exit Terminal mode		L CTRL   R CTRL   x
Upload mode		L CTRL   L CTRL   L

Note: Altering mouse speed is only available in Absolute mode.  
Use main keyboard + and - , not the numeric keypad (see note below).

Note: The switch takes 5 seconds before Upload mode becomes active.

### Alternative layout presets (see Appendix B)

Default eight-host, single-head, dual-display layout	L CTRL   L CTRL   F11   F1
Eight-host, single-head, single-display layout	L CTRL   L CTRL   F11   m
Eight-host layout with top/bottom displays	L CTRL   L CTRL   F11   F2
One dual-head host plus six single-head hosts	L CTRL   L CTRL   F11   F3
Eight single-head hosts with additional fixed display	L CTRL   L CTRL   F11   F7
Four-host dual-head layout	L CTRL   L CTRL   F11   d

Note: The hotkeys assume use of a US keyboard.

#### Using + and – hotkeys

The + and – keys located on the keypad section (on the right side) of your keyboard are NOT supported for use as hotkeys. For hotkey functions such as mouse speed adjustment, use only the + and – keys that are located in the main keyboard section, just to the left of the backspace key. Note also that on non-QWERTY (US/UK) keyboards, these two keys may not be labeled as + and – however, their functions as + and – hotkeys remain valid.

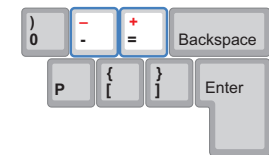

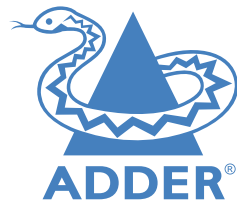

[www.adder.com](http://www.adder.com)

Documentation by: [www.ctxd.com](http://www.ctxd.com)



© 2023 Adder Technology Limited  
All trademarks are acknowledged.  
Part No. MAN-000006 • Release 1.4

- A**
  - Admin
    - default 10
  - Admin account
    - change password 11
    - create new 11
  - Alternative layouts 19
  - Audio hold 14
- C**
  - Channel button
    - colors 11
  - Channel name 12,14,17
  - Colors
    - button indicators 11
  - Configuration menu 10,16,19
  - Connections 6
    - computer 7
    - console 8
    - overview 6
    - power 9
- D**
  - Default admin 10
- F**
  - Factory reset 12
  - Free-Flow 2,13
- G**
  - Guard mode 14
- H**
  - Hotkeys 21
    - changing 12
- L**
  - Layout presets 21
- P**
  - Power in 9
- R**
  - Reset 12
- S**
  - Security information 17
  - Security level tag 17
  - Speakers 8
  - Specifications 3
  - Status display 14
- T**
  - Technical specifications 3