



Operating Manual for ATS-800 Automatic Transfer Switch:

MC80043 – Hardwire 120 V-800-2000,-4000,-6000,-8000(15,20,30, 40 A)

MC80044 – Plugs & Receptacles 120 V-800-200x,-400x(15,20 A)

MC80045 – IEC 230 V-800-3904,-5904(15,20 A)

**MC80046 – Plugs & Receptacles 208 V-800-380x and -580x(15,20 A)
220, 240 V-800-300x and-500x(15,20A)**

**MC80047 – Hardwire 208 V-800-3800,-5800,-7800 and -9800 (15,20,30,40 A)
220, 240 V-800-3000,-5000,-7000 and -9000 (15,20,30,40 A)**

MC80048 – Hardwire 230 V-800-3900,-5900,-7900 and -9900(15,20,30, 40 A)

MC80049 – Hardwire input, IEC output 208, 220, 240 V-800-3011,-5011(15,20 A)

MC80050 – Hardwire input, IEC output 230 V-800-3911,-5911 (15,20 A)

MC80043,4,5,6,7,8,9,50

Rev. 3, April, 2018

SAVE THESE INSTRUCTIONS – This manual contains important instructions for the ATS Series that should be followed during installation and maintenance.

Table of Contents	Page
1. GENERAL	5
1.1 Product Application.....	5
1.2 Safety Alerts.....	6
1.3 General ATS Series Description.....	6
1.4 Overall Dimensions	7
1.5 Construction	8
1.6 Rear Access	8
1.7 Component Locations	10
2. MAJOR COMPONENT/CIRCUIT DESCRIPTIONS	12
2.1 ATS Series System Architecture	12
2.2 ATS Circuit Boards.....	12
2.3 Input / Output Circuit Breakers	16
2.4 Audible Alarm Switch.....	16
3. INSTALLATION	16
3.1 Site Selection & Preparation.....	16
3.2 Required Tools.....	17
3.3 Unpacking & Inspection	17
3.4 Voltage Selection.....	17
3.5 Installing the ATS-800 Series	18
3.6 AC Connections (Hardwire Versions).....	18
4. POWERING UP THE ATS SERIES	20
4.1 Start-Up & Functional (Electrical) Test Procedure	20
4.2 Testing w/Actual Load Equipment (Computer)	21
4.3 Remote Status / Alarm Monitoring.....	21
4.4 Remote Enable Function.....	21
5. REPAIRS & SERVICE	22
5.1 ATS Series Field Repair (Recommended Replacement Parts).....	22
5.2 Returning Defective Circuit Board(s) for Repair.....	22

5.3	Inventory Recommendations for Customer w/Large Numbers of ATS Units.....	22
6.	REFERENCE	23
6.1	Specifications	23
6.2	Product Configurations.....	31
6.3	TSi Power Contact Information.....	32

COPYRIGHT

Copyright © 2018 TSi Power Corporation. All rights reserved.

The information contained in this Document is the property of TSi Power Corporation and contains confidential and proprietary information owned by TSi Power Corporation. Any duplication or disclosure without the written approval of TSi Power Corporation is prohibited.

TRADEMARK

TSi Power, TSi, the TSi Logo and ATS-800-XXXX are trademarks of TSi Power Corporation.

LIMITED WARRANTY

TSi Power Corporation warrants this product to be free from defects in materials and workmanship for two (2) years from the date of purchase from TSi or its authorized representatives. TSi will repair (or at its option, replace) any defective component(s) during this warranty period.

To make a request or claim for service under this limited warranty, the original purchaser must return the product, in the original shipping container or equivalent, to TSi or its authorized agent, accompanied by a written receipt showing the date of purchase and both the model name and serial number of the product.

Warranty does not cover transportation costs. Damage by misuse, accident or unauthorized tampering of the product is not covered by the warranty. NO OTHER WARRANTIES ARE EXPRESSED OR IMPLIED. TSI IS NOT LIABLE FOR CONSEQUENTIAL DAMAGES. THIS WARRANTY GIVES YOU SPECIFIC LEGAL RIGHTS, AND YOU MAY ALSO HAVE OTHER RIGHTS WHICH VARY FROM STATE TO STATE.

LIMITATION OF LIABILITY

IN NO EVENT SHALL TSI POWER CORPORATION BE LIABLE FOR ANY DAMAGES WHATSOEVER (INCLUDING WITHOUT LIMITATION, DAMAGES FOR LOSS OF BUSINESS PROFITS, BUSINESS INTERRUPTION, LOSS OF BUSINESS INFORMATION, OR OTHER PECUNIARY LOSS) ARISING OUT OF THE USE OR INABILITY TO USE THIS PRODUCT, EVEN IF TSI OR ITS AGENT HAVE BEEN ADVISED OF THE POSSIBILITY OF SUCH DAMAGES. SOME STATES DO NOT ALLOW THE LIMITATION OR EXCLUSION OF LIABILITY FOR INCIDENTAL OR CONSEQUENTIAL DAMAGES, SO THE ABOVE EXCLUSIONS MAY NOT APPLY TO YOU.

<u>REVISION NUMBER</u>	<u>DATE</u>	<u>REASON FOR REVISION</u>
0	December, 2015	Initial release
1	February, 2015	Revised Paragraph 4.32 and 4.33
2	November, 2015	Updated model lineup
3	April, 2018	Added 40 A to MC80043, 47 and 48

1. GENERAL

1.1 PRODUCT APPLICATION

The ATS series of automatic transfer switches is designed for applications where two or more autonomous power sources are available. The ATS can be utilized as single or multiple units for different levels of redundancy. Applications include but are not limited to telecom, computers, data centers, industrial control, automatic test equipment, oil exploration and utilities.

The ATS works with asynchronous or out-of-phase power sources which allows them to be used with a number of different sources. Customers with special requirements can be offered custom programming to address special use situations. The ATS is fed by two AC power sources. When the primary power source detector circuit senses a loss of power on that circuit, it immediately switches the load over to the backup power source in typically 1/2 cycle (or ~8 ms) for 60 Hz and typically 1/2 cycle (or ~9.7 ms) for 50 Hz. Upon return of primary power, the ATS will switch back in typically 1/2 cycle (or ~8 ms) for 60 Hz and typically 1/2 cycle (or ~9.7 ms) for 50 Hz. This is fast enough to be invisible to even the most sensitive equipment.



Figure 1: Transfer between primary and backup power



Figure 2: Front View of the Automatic Transfer Switch (with Hardwire Cover shown in Rear)

1.2 SAFETY ALERTS

SAFETY SIGNAL WORD DEFINITIONS

This document contains safety alert pictorial Symbols and Words that point out areas and procedures that require special attention with regards to safety. These Symbols and Words are defined in ANSI Z535.4-1998, Product Safety Signs and Labels.

DANGER:

DANGER indicates an imminently hazardous situation which, if not avoided, will result in death or serious injury.

WARNING:

WARNING indicates a potentially hazardous situation which, if not avoided, will result in death or serious injury.

CAUTION:

CAUTION indicates an imminently hazardous situation which, if not avoided, may result in minor or moderate injury. It may also be used to alert against unsafe practices.

The safety alert pictorial symbol  appears in this document to make users aware of important operating and safety concerns.

NOTE : Specific models of the ATS Series may be ETL Listed to signify conformance with UL, CSA or CE requirements. For actual Listings see individual model specifications in Section 6.1. Users should install the ATS only where permitted and carefully follow the instructions in this manual.

WARNING:

The ATS-800 receives power from two AC sources. To prevent any hazardous situations from occurring, always turn off both circuit breakers in the rear of the ATS unit (see Fig. 4 and 5), as well as the upstream circuit breakers protecting both AC input sources to the ATS unit before connecting or disconnecting the AC input and output wires to the input and output terminal blocks or connecting the plug cables from the rear of the ATS unit.

1.3 GENERAL ATS SERIES DESCRIPTION

- Accepts inputs from asynchronous sources and can be used with most supply voltages, including out-of-phase.
- ~8 to ~9.7 millisecond (ms) transfer time between sources is fast enough for even the most sensitive loads.
- Audible alarm with enable / disable switch provides for unattended security.

- LED status indicators for quick visual displays of fault conditions.
- Higher than 99% efficiency means substantial energy savings (when the ATS is used as a battery-less UPS).
- Remote monitoring is provided through a DB9 port.
- 70-90% reduction in both CAP-EX and OP-EX (when the ATS is used as a battery-less UPS).
- Built-in primary and backup rocker style circuit breakers are highly visible and easily accessible on rear of unit.
- The ATS allows redundant AC power to mission-critical equipment using any combination of UPS, backup generator or other available autonomous AC power sources.
- Sturdy steel enclosure can be front rack mounted to 19" racks by means of integral rack mount ears. For other mounting options consult your local TSi sales associate.
- AC Inputs are galvanically isolated.

1.4 OVERALL DIMENSIONS

The ATS-800 enclosure dimensions are 16.63" (422 mm) wide x 1.7" (43 mm) high x 9" (229mm) deep for Plugs and Receptacles units and 10.5" (267 mm) deep for Hardwire units – see Fig. 3.

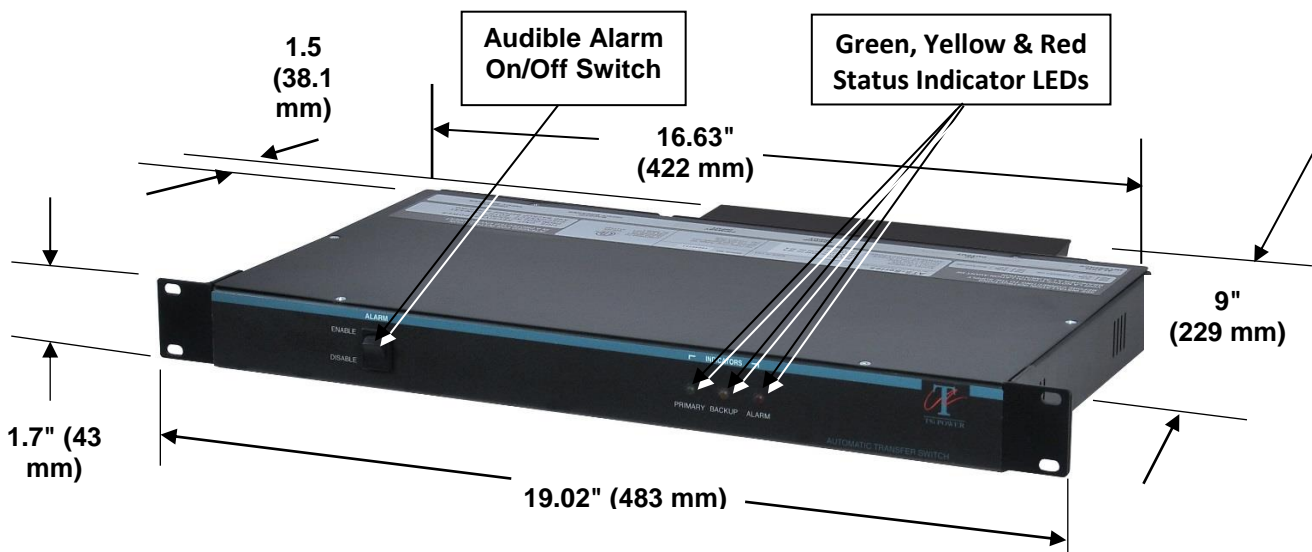

Figure 3: ATS-800 Dimensions for Hardwire Units Shown (black polyester coating shown)

1.5 CONSTRUCTION

The ATS-800 enclosure is constructed of 18 gauge (.048 in. thick), galvaneal steel, as standard, and finished with a liquid black polyester powder coating for long-lasting durability. The cover is easily removeable for servicing.

1.6 REAR ACCESS – See Figures 4, 5, 6, 7 AND 8

The DB-9 Connector, Primary and Backup circuit breakers, Hardwire Termination compartments and Plugs and Receptacles are accessed from the rear of the ATS Series enclosures.

1.61 TOP-DOWN VIEW OF COVER SHOWING MAIN IDENTIFICATION LABEL AND REAR COMPONENT LOCATIONS (for ATS-800-4000 hardwire unit) – See Figure 4.

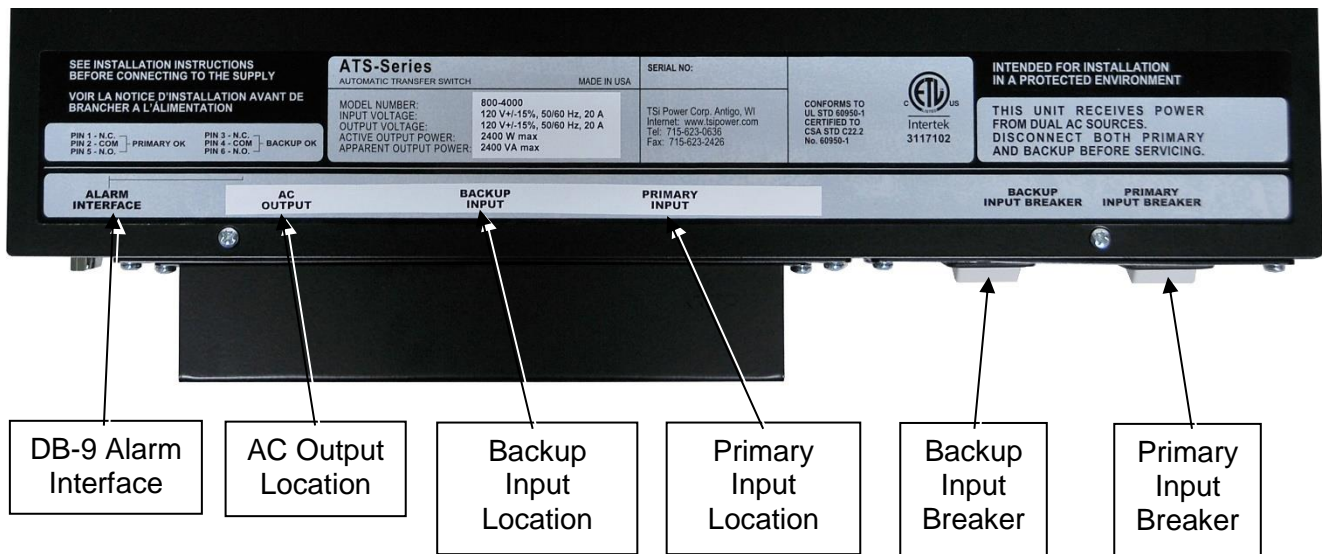

Figure 4: ATS-800-4000 Hardwire top-cover label showing rear compartments/components

1.62 REAR VIEW OF MC80043 UNIT WITH HARDWIRE INPUT AND OUTPUT CONNECTIONS COVER (See Figure 5)

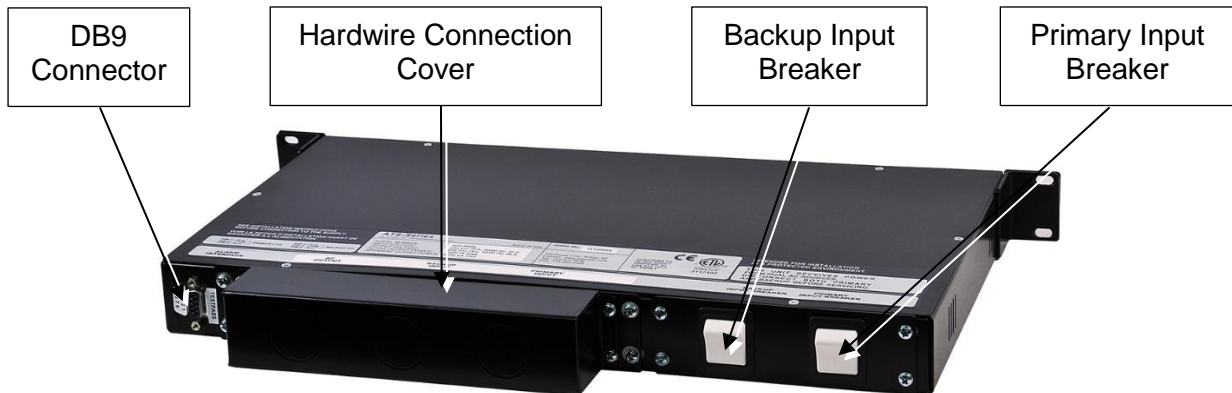

Figure 5: Rear view of ATS-800-6000 Hardwire unit showing DB9 connector, Primary and Backup circuit breakers and cover over Hardwire connections

1.63 REAR VIEW OF MC80044 UNIT WITH PLUGS AND RECEPTACLES (See Figure 6)

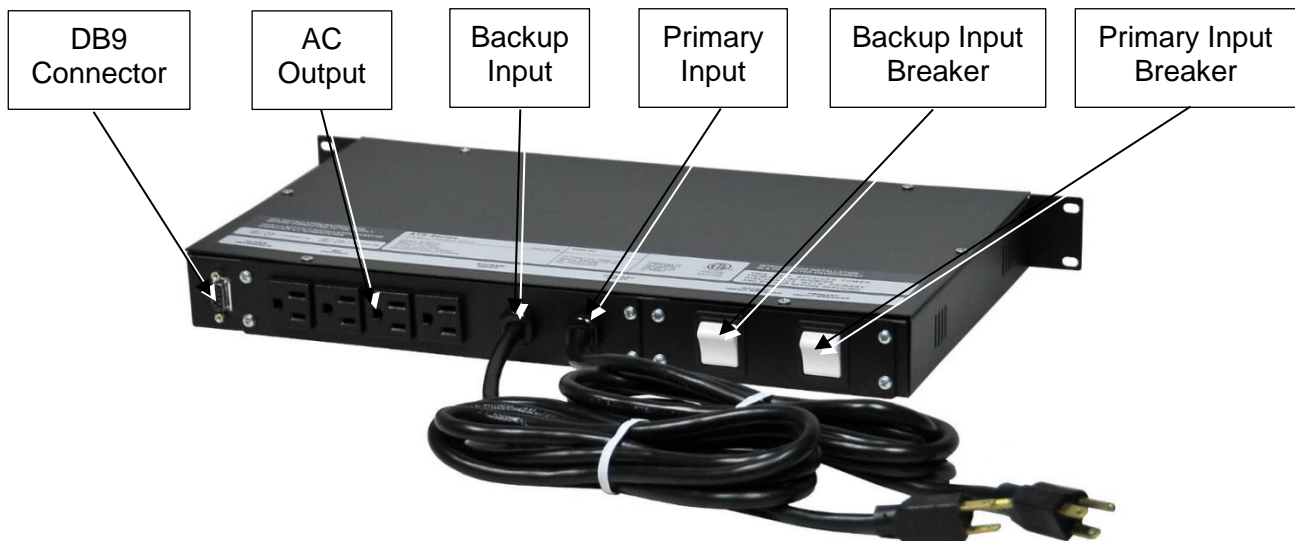

Figure 6: Rear View of ATS-800-2002 Plugs and Receptacles unit showing DB9 connector, Primary and Backup circuit breakers, two 5-15P Input Cord Plugs and four 5-15R AC Output Receptacles

1.64 REAR VIEW OF MC80045 UNIT WITH IEC PLUG AND RECEPTACLES (See Figure 7)

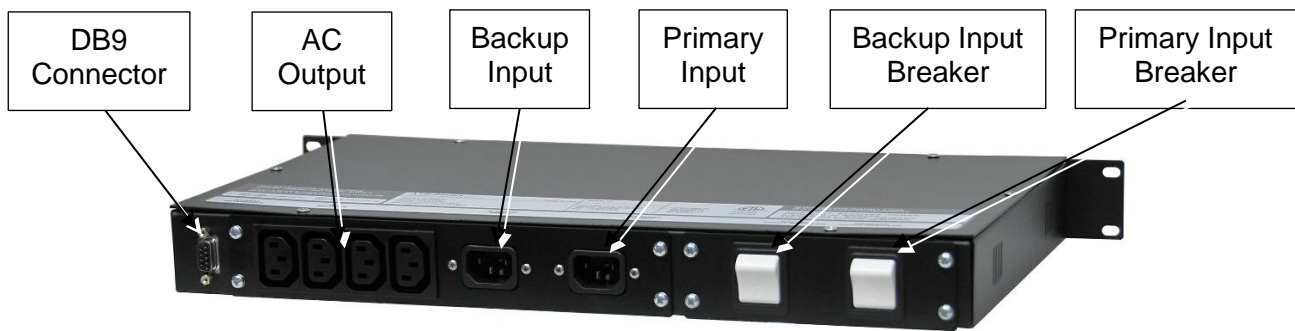

Figure 7: Rear View of ATS-800-3904 Plugs and Receptacles unit showing DB9 connector, Primary and Backup circuit breakers, two IEC60320 C14 Input Plugs and four IEC60320 C13 AC Output Receptacles

1.7 COMPONENT LOCATIONS

1.71 TOP VIEW WITH COVER REMOVED (See Figure 8)

Removing the top cover exposes the main wiring and major components of the ATS Series. Before removing the top cover, make sure that both input circuit breakers are in the “OFF” position and that the up-stream Primary and Backup AC sources are de-energized (switched OFF).

⚠ DANGER: If the unit has already been installed and prior to the removal of the top cover, make sure that both the **PRIMARY** and **BACKUP INPUT CONNECTORS** in the back of the unit have been disconnected and that the up-stream Primary and Backup AC sources are de-energized (switched OFF) - (See Figure 8).

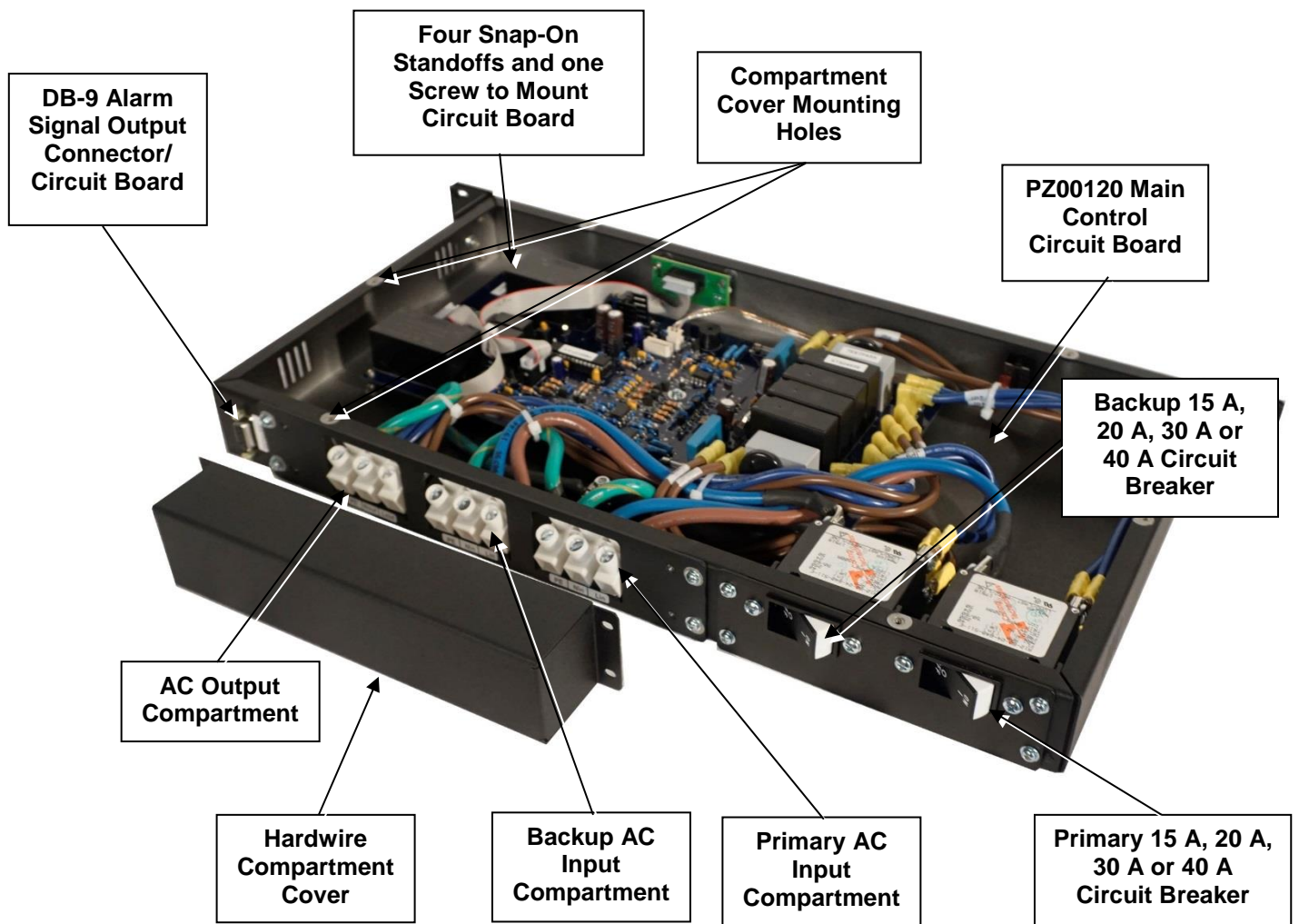

Figure 8: Top-Down Rear view showing Hardwired ATS-800 with top-cover removed

2. MAJOR COMPONENT/CIRCUIT DESCRIPTIONS

2.1 ATS SYSTEM ARCHITECTURE (See Figure 9)

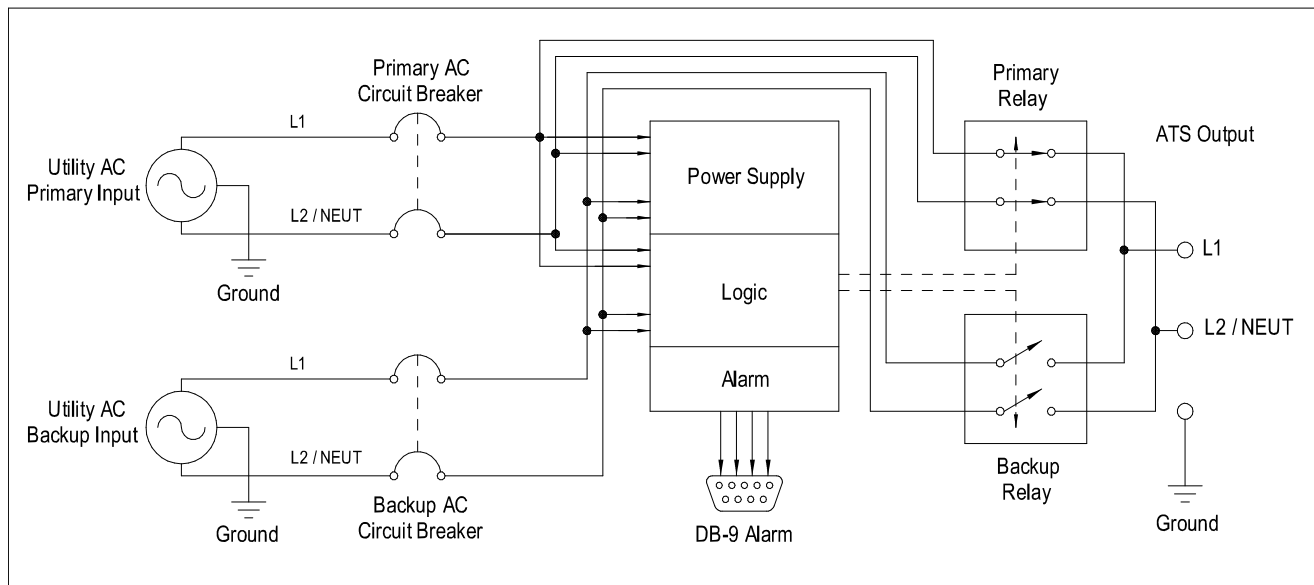

Figure 9: ATS-800 System Architecture

2.2 ATS SERIES CIRCUIT BOARDS

2.2.1 Main Control Circuit Board Assemblies (See Figures 10 and 11)

Two main control circuit boards are used in the ATS Series. The PZ00120-5 is used in the 2000, 3000, 4000, 5000, 6000 and 7000 models, while the PZ00127-5 is used in the models 8000 and 9000. The circuit board assemblies are mounted to the chassis by means of four (4) snap-on standoffs and one M3x0.5 Screw, see Figures 8, 10 and 11.

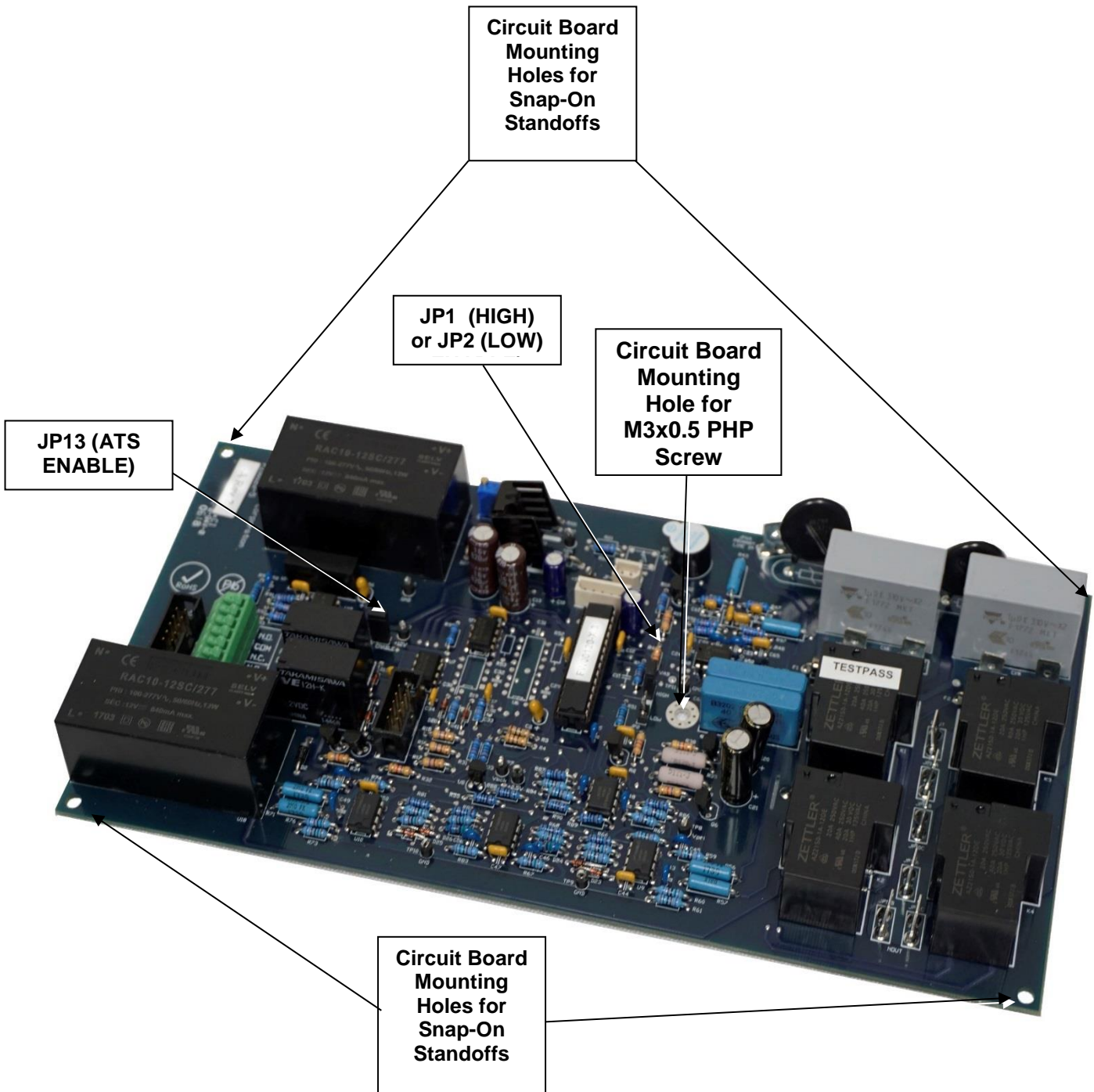

Figure 10: PZ00120-5 Main Control Circuit Board Assembly for ATS-800-2000, -3000, -4000, -5000, -6000 and -7000 models

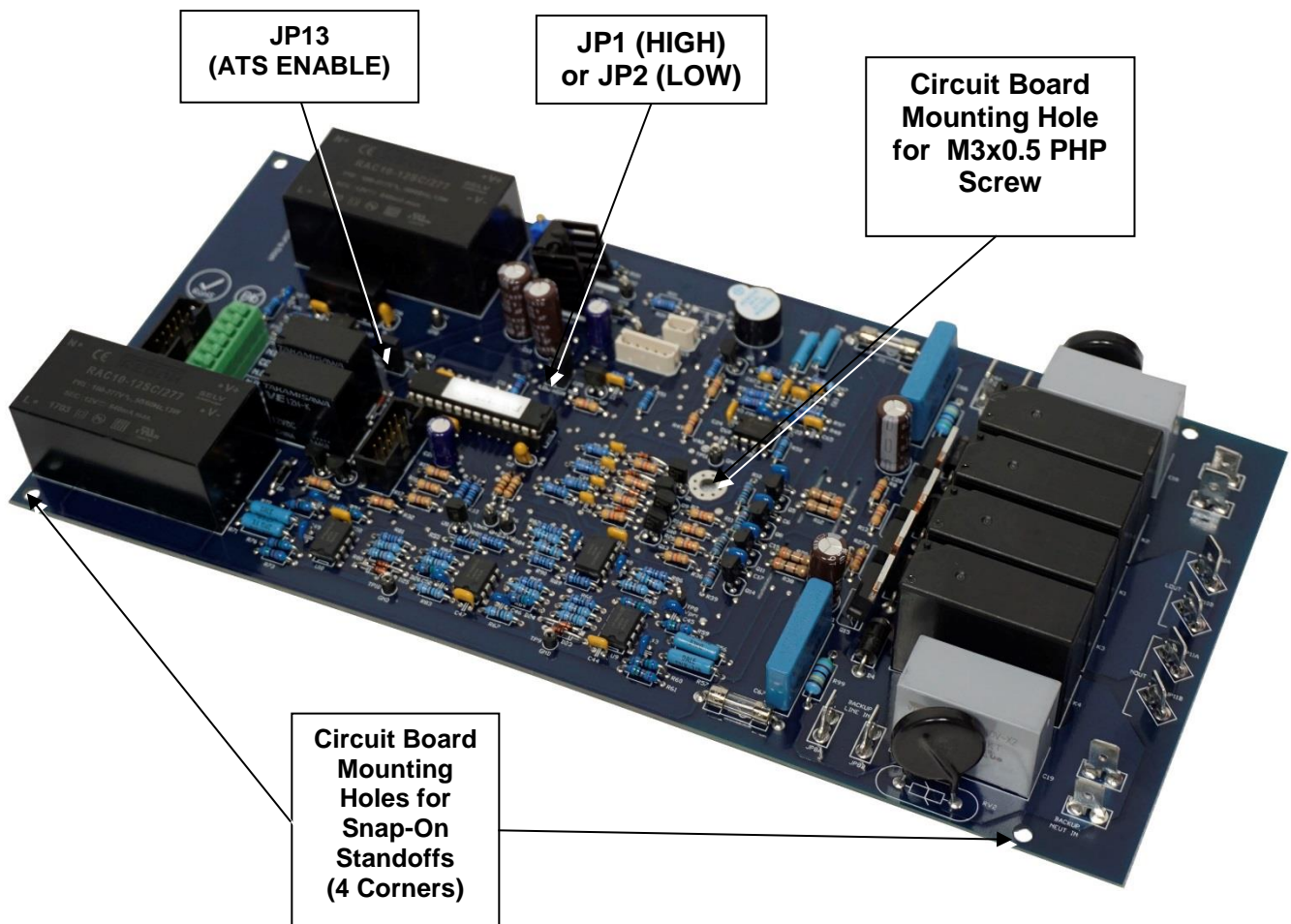

Figure 11: PZ00127-5 Main Control Circuit Board Assembly for ATS-1000-8000 and -9000 models

2.22 DISPLAY CIRCUIT BOARD ASSEMBLY (See Figure 12)

Three colored LEDs are located on the right side of the front panel of the ATS housing and attached by means of a ribbon cable and connector to the main control board. These LEDs, as shown in Figure 3 and 12 signify the following:

- Green “Primary” LED, ON, indicates Primary is driving the output.
- Yellow “Backup” LED, ON, indicates Backup is driving the output.
- Absence of either primary or backup AC source will be indicated by a red “Alarm” LED indicator and audible buzzer (beeper) alarm.

Note: The audible alarm can be turned off by setting the Audible Alarm switch, located on the front panel, to the “OFF” position, see Figure 3.

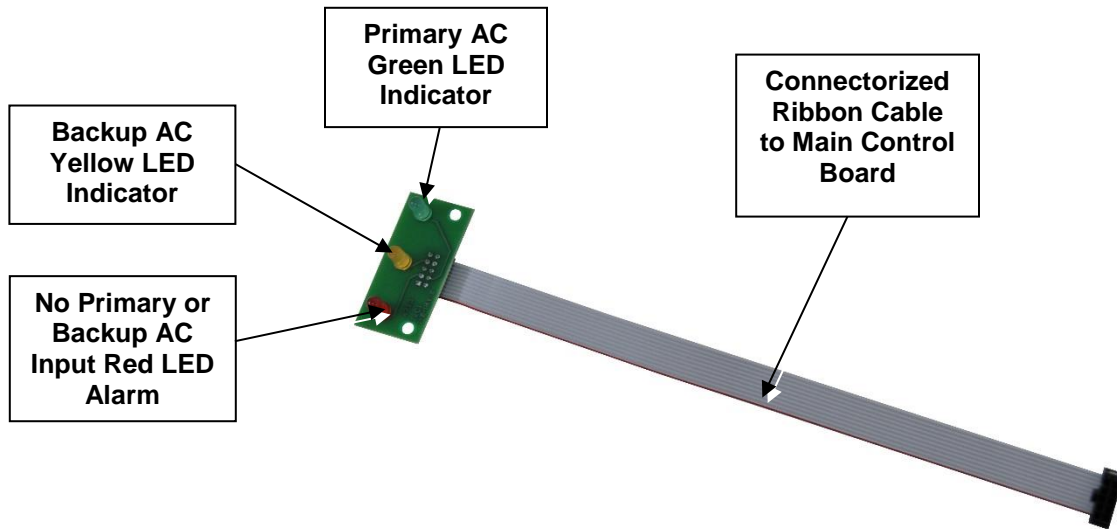

Figure 12: ATS Series Display Board Assembly

2.23 DB-9 ALARM PORT ASSEMBLY (See Figure 13)

Signals can be transmitted by means of the DB-9 connector in the rear of the ATS unit that provide . for remote monitoring of alarms. See Figures 8 and 13. Pin assignments are outlined in section 4.3.



Figure 13: PZ00129 DB-9 Alarm Circuit Board Assembly

2.3 INPUT/OUTPUT CIRCUIT BREAKERS (See Figure 13)

One two-pole circuit breaker (located in the rear of the unit) connects the Primary AC to the ATS unit and another two-pole circuit breaker connects the Backup AC to the ATS unit.

Note: If the output load current exceeds 125% of the circuit breaker ratings (15, 20, 30 or 40 A), then the input circuit breaker(s) will trip and prevent the possibility of overheating of the components or wires inside the ATS Series units. Reduce the load if the circuit breaker trips. If

the circuit breaker trips, even without any load, then there is a faulty component on the board assembly. The Board assembly must then be repaired at the factory (or replaced in the field).



P/N FC00114-15 A & P/N FC00116-30 A Breaker P/N FC00065-40 A Breaker
P/N FC00115-20 A Breaker

Figure 14: Primary & Backup Type AC Input Two-Pole Circuit Breakers-15, 20, 30 & 40 A

2.4 AUDIBLE ALARM SWITCH (See Figure 15)



Figure 15: P/N SE00002 Audible Alarm On/Off Switch

3. INSTALLATION

IMPORTANT: ONLY QUALIFIED PERSONNEL SHOULD PERFORM THE INSTALLATION OF THIS PRODUCT.

3.1 SITE SELECTION & PREPARATION

- This product is intended for installation in “A PROTECTED ENVIRONMENT ONLY”.
- The ATS Series is designed to be mounted in a rack.
- Note the following if an ATS without internal circuit breakers is being installed;
 - For permanently connected equipment, a readily accessible disconnect device shall be incorporated external to the equipment.

- For pluggable equipment, the socket-outlet shall be installed near the equipment and shall be easily accessible.

- The ATS must be protected by an upstream branch circuit protector, for both the Primary and the Backup, at 125% of the ATS current rating (the maximum input current rating as shown on the ATS product label) per the National Electric Code or per local electrical codes if outside of the United States.



CAUTION: THE UNIT MUST BE PLACED IN A WELL - VENTILATED AREA TO PREVENT RISK OF FIRE DUE TO OVERHEATING. VENTILATION SLOTS MUST NOT BE OBSTRUCTED.

- Select an area with enough space to provide sufficient clearance around the unit to provide unrestricted access.

3.2 REQUIRED TOOLS

- Set of standard hand tools
- Wire stripper (for hardwired units)

3.3 UNPACKING & INSPECTION

3.31 The units are shipped in individual cartons and may come stacked on wooden pallets depending on the size of the order. In this configuration, the units are placed on the pallet, with protective material between them.

3.32 Carefully open the cartons, making sure not to damage the units, and remove the protective wrap and packing material.

3.33 Before the units are removed from the cartons, inspect them for physical damage.

3.34 If no damage is found, remove the units from the carton, open the top cover and again inspect for damage. If damage is found in either steps 3.33 or 3.34, do not accept the shipment and file a claim with the carrier. Contact TSi Power for assistance if necessary.

3.4 VOLTAGE SELECTION

3.41 If you have a 208, 220 or 240 V ATS the voltage selection can be changed. The factory setting is either set to HIGH (220 to 240 V) or LOW (208 V) depending on what ATS model was ordered. If the factory preset is not desired, performing the following steps will change the voltage transfer points.

3.42 Make sure both Primary and Backup AC sources to the ATS are de-energized.

3.43 Remove the ATS case cover.

- 3.44 Locate the jumper at JP1 (HIGH) or JP2 (LOW). See Figures 10 or 11.
- 3.45 To change the voltage selection simply move the Jumper from the JP1 (HIGH) to JP2 (LOW) position or JP2 (LOW) to JP1 (HIGH) position (depending on the factory preset of your ATS).
- 3.46 Replace ATS case cover.

3.5 INSTALLING THE ATS-800 SERIES

- 3.51 After the unit has been unpacked and inspected, use the integral 19" rack-mount ears and mount the unit as shown in Figure 16 using the #10-32 UNF that have been provided. If customer has metric equivalent rack holes, M5X.8 screws should be used.

Note: Make sure that the unit has sufficient surrounding space to provide ample air movement for ventilation. The ATS-800 is not ordinarily intended for use in a stacked configuration with other ATS-800 units, although this can be done with care. In the event a stacked installation is planned, please contact TSi Power for assistance.

3.6 CONNECTIONS (HARDWIRE VERSIONS)

NOTES:

- 1) Torque terminations for 15, 20 or 30 A units are 0.79 Nm (7 in-lb) and for the 40 A units are 2.26 Nm (20 in-lb).
- 2) Be sure to follow electric safety and installation codes in the country of use.

- 3.61 Make sure that the up-stream Primary and Backup AC sources are de-energized (switched **OFF**).
- 3.62 Incoming Primary and Backup Power Input, as well as, AC Power Output is through the circular hole in the rear plate of the unit. Remove the rear plate and save hardware before proceeding.
- 3.63 For units w/15 A Circuits Breakers use minimum 14 AWG (2.5mm²) wire [preferably 12 AWG (4mm²)]
For units w/20 A Circuit Breakers use minimum 12 AWG (4mm²) wire [preferably 10 AWG (6mm²)]
For units w/30 A Circuit Breakers use minimum 10 AWG (6mm²) wire [preferably 8 AWG (10mm²)]
For units w/40 A Circuit Breakers use minimum 8 AWG (10mm²) wire

For both power and earth conductors, TSi Power also recommends using stranded copper wire with a 105 °C insulation system.

- 3.64** Allow for sufficient wire length to reach the wiring terminals and leave enough slack to reduce the stress in the wires. Note: Two wires plus ground are required for primary and backup input and ATS output.
- 3.65** Strip approximately 3/8" (10 mm) insulation from the end of each of the three (3) sets of wires and terminate them in the wiring terminals as follows.
- 3.66** Using a slotted screwdriver, terminate the incoming primary wires on the terminal blocks behind the rear cover marked "Primary Input". These terminals are marked as follows:
- **LI** for primary input line (or **L1in** for primary input phase 1)
 - **NI** for primary input neutral (or **L2in** for primary input phase 2)
 - **PE** for primary input protective earth (European systems); **G** for primary input earth ground (North-American systems)
- 3.67** Using a slotted screwdriver, terminate the incoming backup wires on the terminal blocks behind the rear cover marked "Backup Input". These terminals are marked as follows:
- **LI** for backup input line (or **L1in** for backup input phase 1)
 - **NI** for backup input neutral (or **L2in** for backup input phase 2)
 - **PE** for backup input protective earth (European systems); **G** for backup input earth ground (North-American systems)
 -
- 3.68** Using a slotted screwdriver, terminate the outgoing wires on the terminal blocks behind the rear cover marked "AC Output". These terminals are marked as follows:
- **LO** for AC output (or **L1out** for AC output phase 1)
 - **NO** for AC neutral output (or **L2out** for AC output phase 2)
 - **PE** for output protective earth (European systems); **G** for output earth ground (North-American systems)
 -
- 3.69** Carefully insert each wire into the appropriate slot, taking care to ensure that all strands are inserted properly. Tighten the terminal screw using a slotted screwdriver and torque the terminations for the 15, 20 or 30 A units 0.79 Nm (7 in-lb) and for the 40 A are 2.26 Nm (20 in-lb). Perform a pull test to make sure the connection is secure. Do not apply excessive torque to make sure that the terminal screws are not damaged. Note that failure to follow these instructions can lead to malfunction or short circuit.



Figure 16: 19" Rack-Mounting of the ATS-800 Series

4. POWERING UP THE ATS SERIES

4.1 START-UP & FUNCTIONAL (ELECTRICAL) TEST PROCEDURE

(1) Connect (or plug-in) both the Primary and Backup AC input connections (if using a hardwired ATS model this was performed during step 3.6) and energize (turn on) the upstream Primary and Backup AC sources..

Important Note: Make sure that both Primary and Backup AC input voltages and frequencies match those specified on the product label affixed to the ATS unit (see Figure 4). The ATS will only operate when the input voltage is within $\pm 10\%$ and when the input frequency is within $\pm 5\%$ of that specified. Both primary and backup must be the same nominal frequency.

- (2) Turn on the Backup AC circuit breaker in the rear of the ATS unit. Make sure that the audible alarm switch (in front of the ATS unit) is in the "ENABLE" position.
- (3) The yellow LED should turn on and the alarm sound must turn ON (red alarm LED must turn on; green LED must be OFF).
- (4) Turn on the Primary AC input circuit breaker in the rear of the ATS unit.
- (5) The green LED must turn on after several seconds. The yellow LED, red LED and alarm (sound) must turn off.
- (6) Turn off the Primary AC input circuit breaker. The green LED must turn off. The yellow Backup LED must turn ON and the red alarm LED and alarm (sound) must turn ON.
- (7) Turn on the Primary AC input circuit breaker. After several seconds, the ATS must return to the normal operating condition as noted in (5).
- (8) Turn off the Backup AC input circuit breaker.

(9) The green LED must remain ON and the red alarm LED and alarm sound must turn ON (the yellow LED will already be OFF if the unit is operating from the Primary AC source).

(10) Turn on the Backup input circuit breaker. After several seconds, the ATS must return to the normal operating condition as noted in (5).

4.2 TESTING WITH ACTUAL LOAD EQUIPMENT (SUCH AS COMPUTERS, PLC, TELECOM EQUIPMENT, ETC.)

If the above test steps (1) through (10) are performed and the ATS is functioning properly, then actual load equipment can be connected to (or plugged into) the output terminal block (or computer can be connected (or actual equipment to be powered by the ATS Series).

 **CAUTION: To avoid electric shock or accidents, ensure that both Primary & Backup AC sources are de-energized before making the wire connection to the AC sources.**

4.2 REMOTE STATUS / ALARM MONITORING

4.31 A DB-9 female connector in the rear of the unit provides status / alarm signals for remote monitoring of the status of the ATS.

Primary AC Input Status DB-9 Pins are: 5 NO 1 NC 2 COM

Backup AC Input Status DB-9 Pins are: 6 NO 3 NC 4 COM

4.32 When Primary AC Input is present and IN SPECIFICATION, there is an OPEN circuit between pin 5 and pin 2. When Primary AC input is OUT OF SPECIFICATION, there is a CLOSED circuit between pin 5 and pin 2.

4.33 When Backup AC Input is present and IN SPECIFICATION, there is an OPEN circuit between pin 6 and pin 4. When Backup AC input is OUT OF SPECIFICATION, there is a CLOSED circuit between pin 6 and pin 4.

4.34 Maximum voltage and current that can be used for monitoring the status and alarm of the ATS Series is 120 VDC (VAC), 1 A (maximum DB-9 connector rating).

4.4 REMOTE ENABLE FUNCTION

4.41 A DB-9 female connector in the rear of the unit provides pins for remotely turning the ATS on and off. The standard ATS unit has the remote enable disabled. The remote enable can be enabled by performing the following steps.

4.42 Make sure both Primary and Backup AC sources to the ATS are de-energized.

4.43 Remove the ATS case cover.

4.44 Locate and remove the jumper from JP13 (ATS ENABLE). See figure 8.

4.45 Replace ATS case cover. The ATS can now be turned on by a short across Pin 8 (REMOTE ENABLE) and Pin 9 (REMOTE COM) of the DB-9 connector. The ATS is turned off by an open across Pin 8 (REMOTE ENABLE) and Pin 9 (REMOTE COM) of the DB-9 connector.

5. REPAIRS & SERVICE

5.1 ATS SERIES FIELD REPAIR (RECOMMENDED REPLACEMENT PARTS)

The ATS Series is designed to facilitate quick replacement of circuit boards in the field. Therefore, troubleshooting procedures described in this manual are limited to visual inspection and circuit board replacement only. Actual component-level troubleshooting, repair and calibration require the completion of a full training course at TSi Power. For most customers, the most cost-effective way to repair it is to simply replace the board assembly. Spare parts can be ordered from TSi Power directly. The Replacement Parts Table below provides correct part numbers and descriptive information. Please contact TSi Power prior to ordering so that the correct parts for each particular version of the ATS-800 Series will be available.

TABLE of RECOMMENDED REPLACEMENT PARTS

Part Number	Description	Comments
PZ00120-5	Main Control Board assembly for ATS-800-2000, -3, -4, -5, -6 or -7000 models	Customer must provide voltage, amperage & Frequency options
PZ00127-5	Main Control Board assembly for ATS-800-8000 or -9000 and 9900 models	Customer must provide voltage, amperage & Frequency options
PZ00115-1	Display Board assembly for ATS Series	
WA04013	Alarm port assembly for ATS Series	
SE00002	Audible Alarm Switch for ATS Series	
FC00114	Circuit Breaker (250 V, 15 A)	ATS-800-2000,-3000 Models
FC00115	Circuit Breaker (250 V, 20 A)	ATS-800-4000,-5000 Models
FC00116	Circuit Breaker (250 V, 30 A)	ATS-800-6000,-7000 Models
FC00065	Circuit Breaker (250 V, 40 A)	ATS-800-8000,-9000 Models

5.2 RETURNING DEFECTIVE CIRCUIT BOARD(S) FOR REPAIR

- Contact TSi Power via telephone, fax or e-mail to obtain a Return Material Authorization number (RMA). TSi Power requires the 8 digit serial number in the order to determine the warranty status of the unit and to issue a correct RMA number.
- Make sure that returned circuit boards are properly protected with anti-static bubble packs and packed in a sturdy shipping box.
- Mark shipping box with RMA number, using indelible marker pen. Shipping costs, duty and brokerage costs are the responsibility of the customer.

5.3 INVENTORY RECOMMENDATIONS for CUSTOMERS w/LARGE NUMBERS OF ATS UNITS

Since a board exchange is the quickest way to repair an ATS Series failed circuit board, TSi recommends that customers keep at least 3-5% (one board for every 20 or 30 ATS units) in spare boards.

6. REFERENCE

6.1 SPECIFICATIONS

6.1.1 MC80043 ATS-800 SERIES HARDWIRE, 120 V, MODELS 800-2000, -4000, -6000 and -8000

SPECIFICATION	ATS-800-2000	ATS-800-4000	ATS-800-6000	ATS-800-8000
ELECTRICAL				
VA at 120 V	1800	2400	3600	4800
Circuit breaker	15 A	20 A	30 A	40 A
Switching technology	Mechanical relays			
INPUT				
Voltage / Current / Voltage range	120 V / 15, 20, 30, 40 A (92 - 132 V)			
Frequency range	47 to 63 Hz, Caution: Both sources must use same nominal frequency			
Transfer time	Typically ½ cycle (~8 ms for 60 Hz or ~9.7 ms for 50 Hz)			
Input / output wire size	14 AWG (2.08 mm ²)	12 AWG (3.3 mm ²)	10 AWG (5.26 mm ²)	8 AWG (8.36 mm ²)
AC input and output connections	Hardwire terminals (standard Hardwired units must be installed by a qualified electrician)			
OUTPUT				
Voltage / Current	120 V / 15, 20, 30 or 40 A			
Load regulation	1 % from no load to full load			
Power efficiency	99 % or higher			
AC distribution	Hardwire terminals (standard Hardwired units must be installed by a qualified electrician)			
LED indicators:	Green: Primary output, Yellow: Backup output, Red: No primary or backup AC			
Audible alarm	Buzzer beeps when loss of primary or backup AC occurs			
Audible alarm on / off	Enable / Disable switch			
Alarm contacts	Rear-mounted DB-9 connector sends loss of primary / backup AC			
PHYSICAL				
Dimensions: Inches / mm	W: 16.63" / 422 mm H: 1.7" / 43 mm D: 10.5" / 267 mm			
Weight: lbs / kg	8 lbs / 3.63 kg			
Integral 19" Front Rack-Mount	Standard			
ENVIRONMENTAL				
Ambient temperature	32° to 104° F / 0° to 40° C			
AGENCY APPROVALS				
Safety	UL 60950-1 Issue: 2007/03/27 Ed:2 UL Standard for Safety Information Technology Equipment - Safety - Part 1: General Requirements - CSA C22.2#60950-1 Issued: 2007/03/01 Ed:2 Information Technology Equipment Safety Part 1: General Requirements			
WARRANTY				
Warranty	Two year limited warranty covers parts and labor			

TSi Power's ongoing product improvement process makes specifications subject to change. Other companies product names herein are for identification purposes only and may be trademarks of their respective companies.



6.12 MC80044 ATS-800 SERIES PLUGS AND RECEPTACLES, 120 V, MODELS 800-200X AND -400X

SPECIFICATION	ATS-800-200X	ATS-800-400X
ELECTRICAL		
VA at 120 V: -200x / 400x	1800	2400
Circuit breaker: -200x / 400x	15 A	20 A
Switching technology	Mechanical relays	
INPUT		
Voltage / Current / Voltage range	120 V / 15 / 20 A / 92 -132 V	
Frequency range	47 to 63 Hz \pm 5% Caution: Both sources must use same nominal frequency	
Transfer time	Typically 1/2 cycle (~ 8 ms for 69 Hz or ~ 9.7 ms for 50 Hz)	
Plug models: -2002 / -2003 / -2004 Plug models: -4002 / -4004 Plug models: -xxxx	5-15P / L5-15P / IEC 60320 C14 5-20P / IEC 60320 C20 Other configurations available	
OUTPUT		
Voltage / Current	120 V / 15, 20 A	
Load regulation	1 % from no load to full load	
Power efficiency	99 % or higher	
Receptacle models: -2002 / -2003 / -2004 Receptacle models: -4002 / -4004 Receptacle models: -xxxx	5-15R / L5-15R / IEC 60320 C13 5-20R / IEC 60320 C19 Other configurations available	
LED indicators: Green / Yellow / Red	Primary output / Backup output / No primary or backup AC	
Audible alarm	Buzzer beeps when loss of primary or backup AC occurs	
Audible alarm on / off	Enable / Disable switch	
Alarm contacts	Rear-mounted DB-9 connector sends loss of primary / backup AC	
PHYSICAL		
Dimensions: Inches / mm	W: 16" / 406 mm H: 1.7" / 43 mm D: 10.5" / 267 mm	
Weight: lbs / kg	8 lbs / 3.63 kg	
Integral 19" Front Rack-Mount	Standard	
ENVIRONMENTAL		
Ambient temperature	0° to 40° C / 32° to 104° F	
AGENCY		
Safety	UL 60950-1 Issue: 2007/03/27 Ed:2 UL Standard for Safety Information Technology Equipment - Safety - Part 1: General Requirements - CSA C22.2#60950-1 Issued: 2007/03/01 Ed:2 Information Technology Equipment Safety Part 1: General Requirements	
WARRANTY		
Warranty	Two year limited warranty covers parts and labor	

TSi Power's ongoing product improvement process makes specifications subject to change. Other companies product names herein are for identification purposes only and may be trademarks of their respective companies.



6.13 MC80045 ATS-800 SERIES IEC, 230 V, MODELS 800-3904 AND -5904

SPECIFICATION	ATS-800-3904	ATS-800-5904
ELECTRICAL		
VA at 230 V: -3904 / -5904	3450	4600
Circuit breaker: -3904 / 5904	15 A	20 A
Switching technology	Mechanical relays	
INPUT		
Voltage / Current / Voltage range	230 V / 15, 20 A / 184 - 264 V	
Frequency range	47 to 63 Hz, Caution: Both sources must use same nominal frequency	
Transfer time	Typically ½ cycle (~8 ms for 60 Hz or~ 9.7 ms for 50 Hz)	
AC input connections	IEC60320 C-14	IEC60320 C-20
OUTPUT		
Voltage / Current	230 V / 15, 20 A	
Load regulation	1 % from no load to full load	
Power efficiency	99% or higher	
AC output connections	IEC60320 C-13	IEC60320 C-19
LED indicators: Green / Yellow / Red	Primary output / Backup output/ No primary or backup AC	
Audible alarm	Buzzer beeps when loss of primary or backup AC occurs	
Audible alarm on / off	Enable / Disable switch	
Alarm contacts	Rear-mounted DB-9 connector sends loss of primary / backup AC	
PHYSICAL		
Dimensions: mm (in)	W: 422 mm (16.6") H: 43 mm (1.7") D: 229 mm (9")	
Weight: kg	3.63 kg (8 lbs)	
ENVIRONMENTAL		
Ambient temperature	0 ° to 40°	
CE COMPLIANCE		
Safety	EN 60950-1	
EMC	Radiated : EN55022-1 Immunity : EN55024-1	
WARRANTY		
Warranty	Two year limited warranty, parts and labor	

Tsi Power's ongoing product improvement process makes specifications subject to change. Other companies product Names herein are for identification purposes only and may be trademarks of their respective companies.



6.14 MC80046 ATS-800 SERIES PLUGS AND RECEPTACLES, 208, 220 AND 240 V, MODELS 800-380x, -580x, -300x AND -500X

SPECIFICATION	ATS-800-380x	ATS-800-580x	ATS-800-300x	ATS-00-500x
ELECTRICAL				
VA at 208 V	3120	4160		
VA at 220 V			3300	4400
VA at 240 V			3600	4800
Circuit breaker	15 A	20 A	15 A	20 A
Switching technology	Mechanical relays			
INPUT				
Voltage / Current	208 V / 15, 20 A		220 V / 240 V / 15, 20 A	
Voltage range: 208 V	166 - 239 V			
Voltage range: 220 V or 240 V			184 - 264 V	
Frequency range	47 to 63 Hz, Caution: Both sources must use same nominal frequency			
Transfer time	Typically ½ cycle (~8 ms for 60 Hz or ~9.7 ms for 50 Hz)			
Plug models: -3x02 / -3x03 / -3x04 Plug models: -5x02 / -5x03 / -5x04 Plug models: -xxxx	6-15P / L6-15P / IEC 60320 C14 6-20P / L6-20P / IEC 60320 C20 Other configurations available			
OUTPUT				
Voltage / Current	208 V / 15, 20 A		220 V / 240 V / 15, 20 A	
Load regulation	1 % from no load to full load			
Power efficiency	99 % or higher			
Receptacle models: -3x02 / -3x03 / -3x04 Receptacle models: -5x02 / -5x03 / -5x04 Receptacle models: -xxxx	6-15R / L6-15R / IEC 60320 C13 6-20R / L6-20R / IEC 60320 C19 Other configurations available			
LED indicators:	Green: Primary output, Yellow: Backup output, Red: No primary or backup AC			
Audible alarm	Buzzer beeps when loss of primary or backup AC occurs			
Audible alarm on / off	Enable / Disable switch			
Alarm contacts	Rear-mounted DB-9 connector sends loss of primary / backup AC			
PHYSICAL				
Dimensions: Inches (mm)	W: 16.63" (422 mm) H: 1.7" (43 mm) D: 9" (229 mm)			
Weight: lbs / kg	8 lbs / 3.63 kg			
Integral 19" Front Rack-Mount	Standard			
ENVIRONMENTAL				
Ambient temperature	32° to 104° F / 0° to 40° C			
AGENCY APPROVALS				
Safety	UL 60950-1 Issue: 2007/03/27 Ed:2 UL Standard for Safety Information Technology Equipment - Safety - Part 1: General Requirements - CSA C22.2#60950-1 Issued: 2007/03/01 Ed:2 Information Technology Equipment Safety Part 1: General Requirements			
WARRANTY				
Warranty	Two year limited warranty covers parts and labor			

TSi Power's ongoing product improvement process makes specifications subject to change. Other companies product names herein are for identification purposes only and may be trademarks of their respective companies.



6.15 MC80047 ATS-800 SERIES HARDWIRE, 208, 220 and 240 V, Models 800-3800, -5800, -7800, -9800, -3000, -5000, -7000 AND -9000

SPECIFICATION	ATS-800-3800	ATS-800-5800	ATS-800-7800	ATS-800-9800	ATS-800-3000	ATS-800-5000	ATS-800-7000	ATS-800-9000
ELECTRICAL								
VA at 208 V	3120	4160	6240	8320				
VA at 220 V					3300	4400	6600	8800
VA at 240 V					3600	4800	7200	9600
Circuit breaker	15 A	20 A	30 A	40 A	15 A	20 A	30 A	40 A
Switching technology	Mechanical relays							
INPUT								
Voltage / Current	208 V / 15, 20, 30, 40 A				220 V / 240 V / 15, 20, 30, 40 A			
Voltage range: 208 V	166 - 239 V							
Voltage range: 220 V or 240 V					184 - 264 V			
Frequency range	47 to 63 Hz, Caution: Both sources must use same nominal frequency							
Transfer time	Typically ½ cycle (~8 ms for 60 Hz or ~9.7 ms for 50 Hz)							
AC input connections	Hardwire terminals (standard Hardwired units must be installed by a qualified electrician)							
OUTPUT								
Voltage / Current	208 V / 15, 20, 30 or 40 A				220 or 240 V / 15, 20, 30 or 40 A			
Load regulation	1 % from no load to full load							
Power efficiency	99 % or higher							
AC distribution	Hardwire terminals (standard Hardwired units must be installed by a qualified electrician)							
LED indicators:	Green: Primary output, Yellow: Backup output, Red: No primary or backup AC							
Audible alarm	Buzzer beeps when loss of primary or backup AC occurs							
Audible alarm on / off	Enable / Disable switch							
Alarm contacts	Rear-mounted DB-9 connector sends loss of primary / backup AC							
PHYSICAL								
Dimensions: Inches / mm	W: 16.63" / 422 mm H: 1.7" / 4.3 mm D: 10.5" / 267 mm							
Weight: lbs / kg	8 lbs / 3.63 kg							
Integral 19" Front Rack-Mount	Standard							
ENVIRONMENTAL								
Ambient temperature	32° to 104° F / 0° to 40° C							
AGENCY APPROVALS								
Safety	UL 60950-1 Issue: 2007/03/27 Ed:2 UL Standard for Safety Information Technology Equipment - Safety - Part 1: General Requirements - CSA C22.2#60950-1 Issued: 2007/03/01 Ed:2 Information Technology Equipment Safety Part 1: General Requirements							
WARRANTY								
Warranty	Two year limited warranty covers parts and labor							

TSi Power's ongoing product improvement process makes specifications subject to change. Other companies product names herein are for identification purposes only and may be trademarks of their respective companies.



6.16 MC80048 ATS-800 SERIES HARDWIRE, 230 V, MODELS 800-3900, -5900, -7900 AND -9900

SPECIFICATION	ATS-800-3900	ATS-800-5900	ATS-800-7900	ATS-800-9900
ELECTRICAL				
VA at 230 V	3450	4600	6900	9200
Circuit breaker	15 A	20 A	30 A	40 A
Switching technology	Mechanical relays			
INPUT				
Voltage / Current / Voltage range	230 V / 15, 20, 30, 40 A (184 - 264 V)			
Frequency range	47 to 63 Hz, Caution: Both sources must use same nominal frequency			
Transfer time	Typically ½ cycle (~8 ms for 60 Hz or ~9.7 ms for 50 Hz)			
AC input and output connections	Hardwire terminals (standard Hardwired units must be installed by a qualified electrician)			
OUTPUT				
Voltage / Current	230 V / 15, 20, 30 or 40A			
Load regulation	1 % from no load to full load			
Power efficiency	99 % or higher			
AC distribution	Hardwire terminals (standard Hardwired units must be installed by a qualified electrician)			
LED indicators:	Green: Primary output, Yellow: Backup output, Red: No primary or backup AC			
Audible alarm	Buzzer beeps when loss of primary or backup AC occurs			
Audible alarm on / off	Enable / Disable switch			
Alarm contacts	Rear-mounted DB-9 connector sends loss of primary / backup AC			
PHYSICAL				
Dimensions: Inches / mm	W: 422 mm / 16.63" H: 43 mm / 1.7" D: 267 mm / 10.5"			
Weight: lbs / kg	3.63 kg / 8 lbs			
Integral 19" Front Rack-Mount	Standard			
ENVIRONMENTAL				
Ambient temperature	0° to 40° C / 32° to 104° F			
AGENCY APPROVALS				
Safety	EN 60950-1			
EMC	Radiated: EN55022-1 Immunity: EN55024			
WARRANTY				
Warranty	Two year limited warranty covers parts and labor			

TSi Power's ongoing product improvement process makes specifications subject to change. Other companies product names herein are for identification purposes only and may be trademarks of their respective companies.



6.17 MC80049 ATS-800 SERIES HARDWIRE INPUT, IEC OUTPUT 208, 220, 240 V, MODELS 800-3811, -5811, -3011 AND -5011

SPECIFICATION	ATS-800-3811	ATS-800-5811	ATS-800-3011	ATS-800-5011
ELECTRICAL				
VA at 208 V	3120	4160		
VA at 220 V			3300	4400
VA at 240 V			3600	4800
Circuit breaker	15 A	20 A	15 A	20 A
Switching technology	Mechanical relays			
INPUT				
Voltage / Current	208 V / 15, 20 A		220 V / 240 V / 15, 20 A	
Voltage range: 208 V	166 - 239 V			
Voltage range: 220 V or 240 V			184 - 264 V	
Frequency range	47 to 63 Hz, Caution: Both sources must use same nominal frequency			
Transfer time	Typically ½ cycle (~8 ms for 60 Hz or ~9.7 ms for 50 Hz)			
AC input connections	Hardwire terminals (standard Hardwired units must be installed by a qualified electrician)			
OUTPUT				
Voltage / Current	208 V / 15, 20, 30 or 40 A		220 or 240 V / 15, 20, 30 or 40 A	
Load regulation	1 % from no load to full load			
Power efficiency	99 % or higher			
AC distribution	IEC60320 C-13	IEC60320 C-19	IEC60320 C-13	IEC60320 C-19
LED indicators:	Green: Primary output, Yellow: Backup output, Red: No primary or backup AC			
Audible alarm	Buzzer beeps when loss of primary or backup AC occurs			
Audible alarm on / off	Enable / Disable switch			
Alarm contacts	Rear-mounted DB-9 connector sends loss of primary / backup AC			
PHYSICAL				
Dimensions: Inches / mm	W: 16.63" / 422 mm H: 1.7" / 43 mm D: 10.5" / 267 mm			
Weight: lbs / kg	8 lbs / 3.63 kg			
Integral 19" Front Rack-Mount	Standard			
ENVIRONMENTAL				
Ambient temperature	32° to 104° F / 0° to 40° C			
AGENCY APPROVALS				
Safety	UL 60950-1 Issue: 2007/03/27 Ed:2 UL Standard for Safety Information Technology Equipment - Safety - Part 1: General Requirements - CSA C22.2#60950-1 Issued: 2007/03/01 Ed:2 Information Technology Equipment Safety Part 1: General Requirements			
WARRANTY				
Warranty	Two year limited warranty covers parts and labor			

TSi Power's ongoing product improvement process makes specifications subject to change. Other companies product names herein are for identification purposes only and may be trademarks of their respective companies.



6.18 MC80050 ATS-800 SERIES HARDWIRE, 230 V, MODELS 800-3911 AND -5911

SPECIFICATION	ATS-800-3911	ATS-800-5911
ELECTRICAL		
VA at 230 V	3450	4600
Circuit breaker	15 A	20 A
Switching technology	Mechanical relays	
INPUT		
Voltage / Current	230 V / 15 A	230 V / 20 A
Frequency range	47 to 63 Hz, Caution: Both sources must use same nominal frequency	
Transfer time	Typically ½ cycle (~8 ms for 60 Hz or ~9.7 ms for 50 Hz)	
AC input connections	Hardwire terminals (standard Hardwired units must be installed by a qualified electrician)	
OUTPUT		
Voltage / Current	230 V / 15 A	230 V / 20 A
Load regulation	1 % from no load to full load	
Power efficiency	99 % or higher	
AC distribution	IEC 60320 C - 13	IEC 60320 C - 19
LED indicators:	Green: Primary output, Yellow: Backup output, Red: No primary or backup AC	
Audible alarm	Buzzer beeps when loss of primary or backup AC occurs	
Audible alarm on / off	Enable / Disable switch	
Alarm contacts	Rear-mounted DB-9 connector sends loss of primary / backup AC	
PHYSICAL		
Dimensions: mm / inches	W: 422 mm / 16.63" H: 43 mm / 1.7" D: 267 mm / 10.5"	
Weight: kg / lbs	8 lbs / 3.63 kg	
Integral 19" Front Rack-Mount	Standard	
ENVIRONMENTAL		
Ambient temperature	0° to 40° C / 32° to 104° F	
AGENCY APPROVALS		
Safety	EN 60950-1	
EMC	Radiated: EN55022-1 Immunity: EN55024	
WARRANTY		
Warranty	Two year limited warranty covers parts and labor	

TSi Power's ongoing product improvement process makes specifications subject to change. Other companies product names herein are for identification purposes only and may be trademarks of their respective companies.



6.2 PRODUCT CONFIGURATIONS

The following table shows the different product configurations (Model Numbers) that are available in the ATS-800 Series. The tables show models that are ETL listed and models that carry the CE mark. Each model number is comprised of the 800 Family Identifier followed by a four digit suffix, which signifies the Model configuration. These model configurations relate to the amps, voltage, frequency, input and output type and cord descriptive information that comprises the product to be ordered. For example: **Part # ATS-800-2003** is a 15 A, 120 V, 50/ 60 Hz, ATS-800 unit with L5-15P (JP00055) input Plug and L5-15R output Receptacle and 6 foot long Cord (WI40302).

ATS-800 Series Configuration						
TSi P/N	Amps	Voltage options	Freq. options	Input type	Output type	Cord
ATS-800-2000	15	120 V	50/60 Hz	Hardwire (JP00001)	Hardwire (JP00001)	N/A
ATS-800-2002	15	120 V	50/60 Hz	5-15P (WD00006)	5-15R (JP00155)	6'
ATS-800-2003	15	120 V	50/60 Hz	L5-15P (JP00055)	L5-15R (JP00056)	6' (WI40302)
ATS-800-2004	15	120 V	50/60 Hz	IEC320 C-14 (JP00015)	IEC320 C-13 (JP00101)	Optional
ATS-800-3000	15	220 V, 240 V	50/60 Hz	Hardwire (JP00001)	Hardwire (JP00001)	N/A
ATS-800-3002	15	220 V, 240 V	50/60 Hz	6-15P (JP00042)	6-15R (JP00043)	6' (WI40302)
ATS-800-3003	15	220 V, 240 V	50/60 Hz	L6-15P (JP00046)	L6-15R (JP00059)	6' (WI40302)
ATS-800-3004	15	220 V, 240 V	50/60 Hz	IEC320 C-14 (JP00015)	IEC320 C-13 (JP00101)	Optional
ATS-800-3011	15	220 V, 240 V	50/60 Hz	Hardwire (JP00001)	IEC320 C-13 (JP00101)	N/A
ATS-800-3800	15	208 V	50/60 Hz	Hardwire (JP00001)	Hardwire (JP00001)	N/A
ATS-800-3802	15	208 V	50/60 HZ	6-15P (JP00042)	6-15R 9JP00043)	6' (WI40302)
ATS-800-3803	15	208 V	50/60 Hz	L6-15P (JP00046)	6-15R (JP00059)	6' (WI40302)
ATS-800-3804	15	208 V	50/60 Hz	IEC320 C-14 (JP00015)	IEC320 C-13 (JP00101)	Optional
ATS-800-3811	15	208 V	50/60 Hz	Hardwire (JP00001)	Hardwire (JP00001)	N/A
TSi P/N	Amps	Voltage options	Freq. options	Input type	Output type	Cord
ATS-800-3900	15	230 V	50/60 Hz	Hardwire (JP00001)	Hardwire (JP00001)	N/A
ATS-800-3904	15	230 V	50/60 Hz	IEC320 C-14 (JP00015)	IEC320 C-13 (JP00101)	Optional
ATS-800-4000	20	120 V	50/60 Hz	Hardwire JP00001)	Hardwire (JP00001)	NA
ATS-800-4002	20	120 V	50/60 Hz	5-20P (JP00027)	5-20R (JP00090)	6' (WI40301)
ATS-800-4004	20	120 V	50/60 HZ	IEC60320 C-20 (JP00100)	IEC60320 C-19 (JP00121)	Optional
ATS-800-5000	20	220 V, 240 V	50/60 Hz	Hardwire (JP00001)	Hardwire (JP00001)	N/A
ATS-800-5002	20	220 V, 240 V	50/60 Hz	6-20P (JP00025)	6-20R (JP00039)	6' (WI40301)

ATS-800-5004	20	220 V, 240 V	50/60 Hz	IEC60320 C-20 (JP00100)	IEC60320 C-19 (JP00121)	Optional
ATS-800-5011	20	220 V, 240 V	50/60 Hz	Hardwire (JP00001)	IEC60320 C-19 (JP00121)	N/A
ATS-800-5800	20	208 V	50/60 Hz	Hardwire (JP00001)	Hardwire (JP00001)	N/A
ATS-800-5802	20	208 V	50/60 Hz	6-20P (JP00025)	6-20R (JP00039)	6' (WI40301)
ATS-800-5804	20	208 V	50/60 Hz	IEC60320 C-20 (JP00100)	IEC60320 C-19 (JP00121)	Optional
ATS-800-5811	20	208 V	50/60 Hz	Hardwire (JP00001)	IEC60320 C-19 (JP00121)	N/A
ATS-800-5900	20	230 V	50/60 Hz	Hardwire (JP00001)	Hardwire (JP00001)	N/A
ATS-800-5904	20	230 V	50/60 Hz	IEC60320 C-20 (JP00100)	IEC60320 C-19 (JP00121)	Optional
ATS-800-6000	30	120 V	50/60 Hz	Hardwire (JP00001)	Hardwire (JP00001)	N/A
ATS-800-7000	30	220 V, 240 V	50/60 Hz	Hardwire (JP00001)	Hardwire (JP00001)	N/A
ATS-800-7800	30	208 V	50/60 Hz	Hardwire (JP00001)	Hardwire (JP00001)	N/A
ATS-800-7900	30	230 V	50/60 Hz	Hardwire (JP00001)	Hardwire (JP00001)	N/A
ATS-800-8000	40	120 V	50/60 Hz	Hardwire (JP00044)	Hardwire (JP00044)	N/A
ATS-800-9000	40	220 V, 240 V	50/60 Hz	Hardwire (JP00044)	Hardwire (JP00044)	N/A
TSi P/N	Amps	Voltage options	Freq. options	Input type	Output type	Cord
ATS-800-9800	40	208 V	50/60 Hz	Hardwire (JP00044)	Hardwire (JP00044)	N/A
ATS-800-9900	40	230 V	50/60 Hz	Hardwire (JP00044)	Hardwire (JP00044)	N/A

6.3 TSi POWER CONTACT INFORMATION

TSi Power Corporation
1103 West Pierce Avenue
Antigo, WI 54409, USA
Toll-Free Tel: 800-874-3160 (for USA & Canada only)
Tel: +1-715-623-0636
Fax: +1-715-623-2426
URL: www.tsipower.com E-mail: sales@tsipower.com