

Instruction Manual



A70-RL Kit with 2304 Rain
Bucket

PRODUCTS COVERED:

A70-RL0-T/E
A70-RL0-T/M
A70-RL0-N4XFG/E

DOCUMENT VERSION:

210426

INTRODUCTION:



A70-RLX

Rainfall Transmitter

The A70 Rainfall Transmitter converts the signal from the tipping bucket rain gauge into an electrical signal for input to a computer, meters or other instrumentation. It features reliability, low cost, low power drain, accuracy, simplicity of operation and ruggedness.

In ramp mode each tip of the bucket causes the output signal to increase 1% of full scale. Each complete excursion of the output signal from zero to full scale represents 100 tips of the bucket. This corresponds to one inch or 100 mm of rainfall depending on the calibration of the rain gage. During periods of no rain there is no change in the output signal.

In rain detector mode each tip of the bucket causes the output to change to full scale for a user selectable time period of 1 to 80 minutes. The timer in the rainfall detector mode is retriggerable meaning that a new time period starts with each tip of the bucket. If bucket tips occur faster than the selected time period the output will remain continuously at full scale.

The Transmitter is protected from lightning damage and high voltage surges with metal oxide varistors.

DESCRIPTION:

The system consists of the Rain Gauge and Transmitter. The Rain Gauge is fabricated of heavy duty PVC, aluminum and stainless steel. It consists of an outer funnel, screen, inner funnel and tipping bucket assembly.

Precipitation entering the collection orifice fills the calibrated tipping bucket assembly. When the bucket fills to the calibrated amount, the bucket tips. Another bucket is brought into place and the precipitation sample is discharged through the dump tubes to the ground below. This produces a switch closure which is detected by the electronics in the Transmitter.

The electronics in the Transmitter count the switch closures from the rain gauge. In ramp mode, the counter drives a digital to analog converter which produces a current signal which increases as counts are accumulated. The current signal drives the output amplifier.

In rain detector mode each tip of the bucket causes the output to change to full scale for a user selectable time period of 1 to 80 minutes. The timer in the rainfall detector mode is retriggerable meaning that a new time period starts with each tip of the bucket. If bucket tips occur faster than the selected time period the output will remain continuously at full scale.

Running average and other signal output formats are available. Contact Comptus for additional information.

FEATURES:

- Exceeds NWS and EPA Specifications
- Removable housing for ease of maintenance
- Built In Bubble Level
- 8" Body and Orifice Funnel made of 304 Stainless Steel
- Ceramic Magnet

APPLICATIONS:

- Meteorological Studies
- Environmental Research

-Stormwater, Wastewater, Irrigation Monitoring and Controls

SPECIFICATIONS:

Input Device:	Comptus 2304 Tipping Bucket
Range:	25 mm (1 in)
Resolution:	0.25 mm (0.01 in)
Accuracy:	Electronics - $\pm 1\%$ Rain Gauge - See Comptus 2304 Rain Bucket Spec Sheet
Electronics:	Input - 12-24 VDC Input Device - Comptus 2304 Rain Bucket Output - 4-20 mA, 1-80 minute pulse period Terminal Strip - Accepts AWG #12 - #22 Wire Cable - 50'
Environmental:	Electronics - 0°C to 70°C (-40°C to 70°C available) Rain Bucket - See Comptus 2304 Rain Bucket Spec Sheet
Dimensions:	6.1" x 2.75" x 12"
Weight:	Transmitter (Track Mounted) - 0.45 kg (1 lb) Comptus 2304 Rain Bucket - 3.5 kg (7.7 lbs)

POWER SUPPLY:

A 15 - 24 VDC power supply is recommended for operation of this instrument. Voltage ripple must be less than 100 volts per second for proper operation. A 12 volt power supply can drive a current loop with a total resistance of 100 ohms. A 15 volt power supply can drive a current loop with a total resistance of 250 ohms. See Figure 4.

Before proceeding verify that the maximum resistance of the current loop including the wiring and sensing element does not exceed the maximum given by Formula 3. If this resistance is exceeded the loop current will not attain full scale. The resistance of various gages of copper wire is given in Table 1.

1. Refer to Figure 3. The two wires from the gage should be attached to terminals 3 & 4 on the Transmitter circuit board. Polarity is not important.
2. Refer to Figure 3 & 5. Connect the output terminals 1(-) & 2 (+) to the desired meter on computer. Be sure to observe polarity.

RAMP MODE OUTPUT SIGNAL

Figure 1

RAIN DETECTOR MODE

OUTPUT SIGNAL

Figure 2

Ramp Mode Output Signal

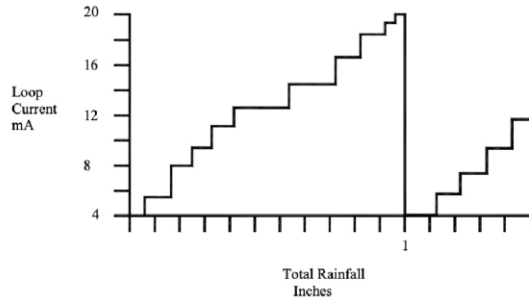

Rain Detector Mode Output Signal

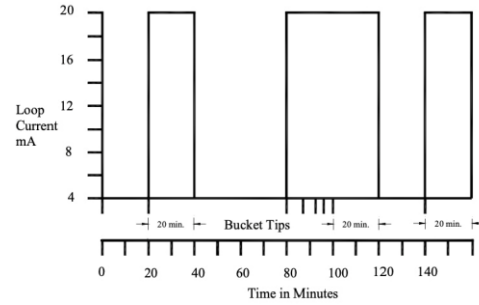

INSTALLATION:

Do not install this equipment in the same enclosure with a liquid electrolyte battery unless ventilation is provided. Various gasses emitted from the battery will cause both premature and intermittent circuit failure.

SENSOR LOCATION:

It is necessary to shield the gauge from the wind to obtain an accurate measure of precipitation. Trees, bushes and shrubbery provide natural shields from the wind. The gauge must be clear of obstructions or surfaces that could drip or splash water into the orifice. The gauge should be located in the center of a circle clear of obstructions. The radius of the circle should be at least twice the height of the surrounding vegetation. If natural protection is unavailable, a wind shield will be required. In locations where heavy snowfall occurs the gauge should be mounted on a tower, high above the average snow level.

A stable, level mounting platform approximately 18 inches (0.5 meter) square is required to attach the rain gauge. The platform can be fabricated of concrete, treated wood or any other suitable material.

INSTALLATION NOTE:

Loosen the three fixed screws at the bottom of the rain bucket then remove the collector. Inside remove the rubber band holding the tipping bucket in place.

A bubble level is attached to the base for leveling the unit. Use the screws on the three feet to adjust. Reinstall the collector and secure the three screws.

RESISTANCE OF COPPER WIRE

Table 1

COMPONENT LAYOUT

Figure 3

AWG	Resistance Ohms / foot
12	.0016
14	.0026
16	.0041
18	.0065
20	.0103
22	.0165
24	.0262

GRAPH OF MAXIMUM LOOP RESISTANCE

Figure 4

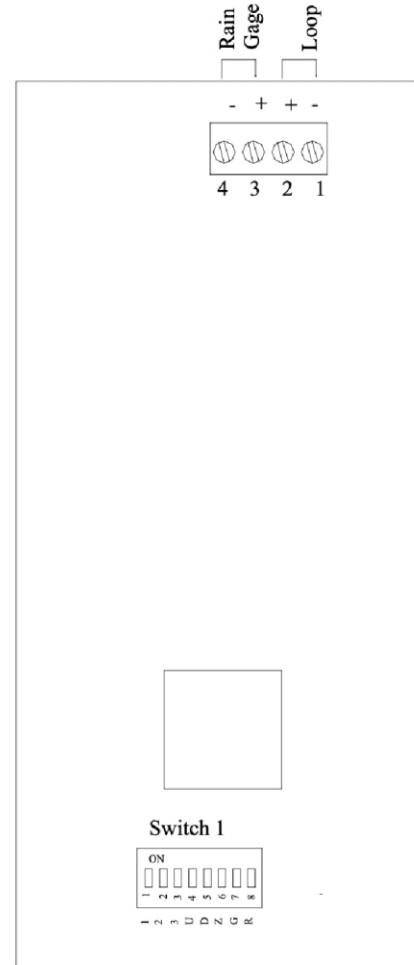
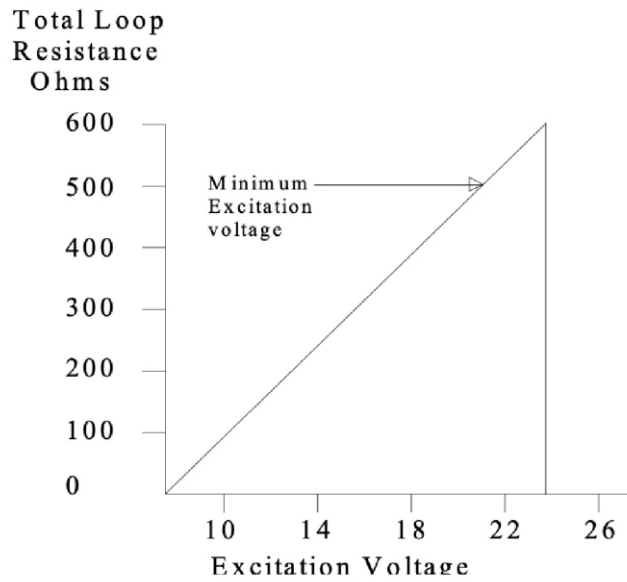

TRANSMITTER CONNECTION DIAGRAM

Figure 5

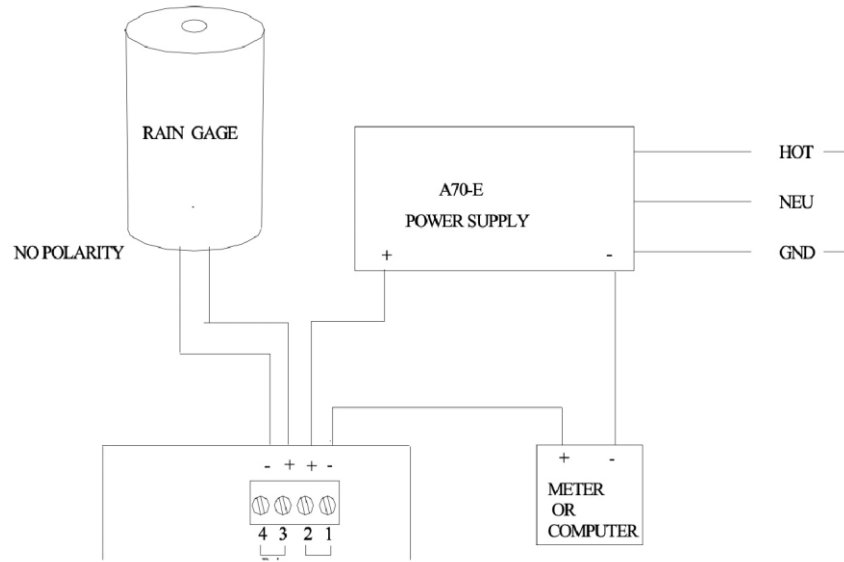

MULTIPLE TRANSMITTERS SHARING ONE POWER SUPPLY

Figure 6

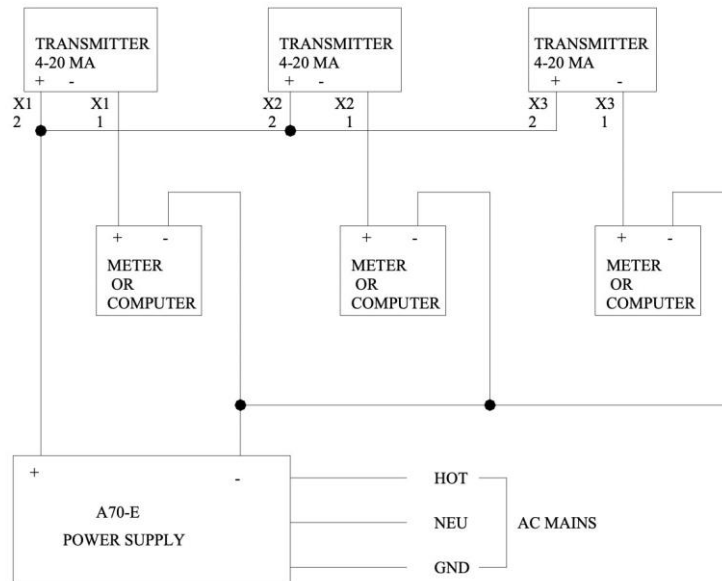

GRAPH RAMP MODE RAINFALL TRANSFER FUNCTION

Figure 7

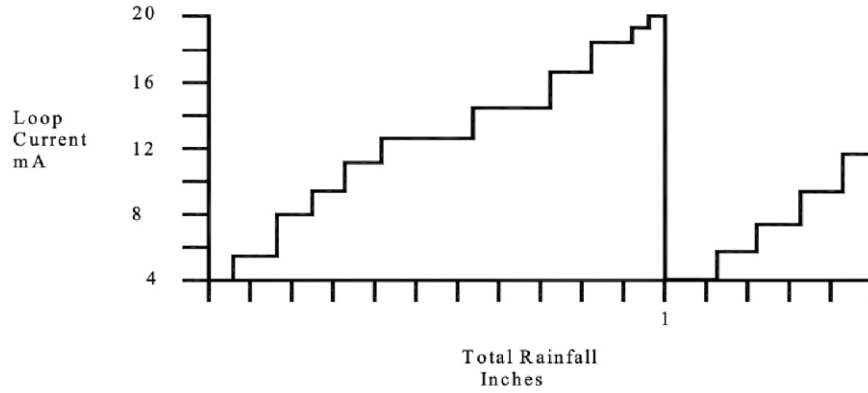

RAIN DETECTOR MODE TRANSFER FUNCTION

Figure 8

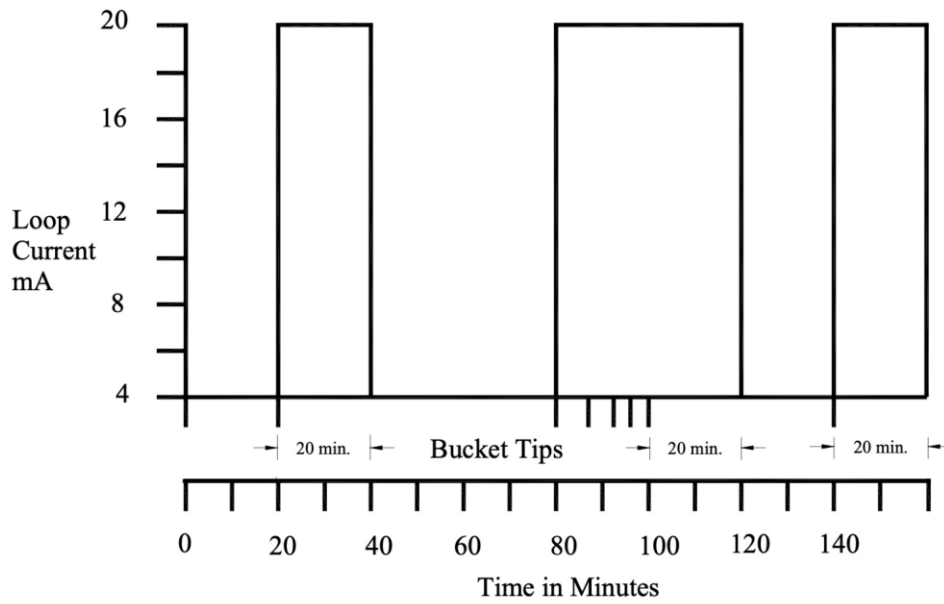

RAIN DETECTOR TIMER CALIBRATION

Figure 9

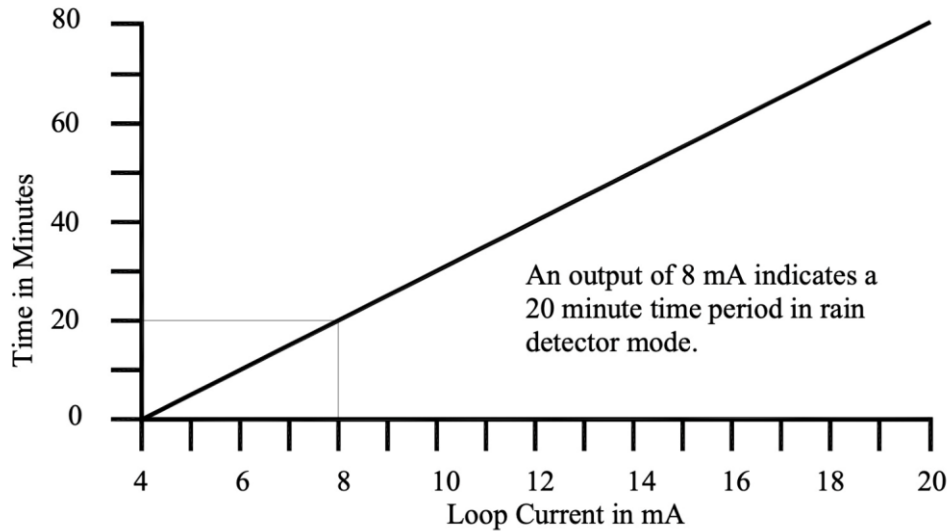

TRANSFER FUNCTION

Formula 1

R = Rainfall in Inches I = Loop Current in Milliampères I = Loop Current in Milliampères R
= Resistance in Ohms

$$R = (I - 4\text{mA}) / 16$$

VOLTAGE ACROSS SENSING RESISTOR

Formula 2

V = Voltage in Volts

$$V = I \times R / 1000$$

MAXIMUM LOOP RESISTANCE for 4-20 mA OUTPUT TRANSMITTER

Formula 3

Rmax = Maximum Loop Resistance in Milliampères T = Time in Minutes Vsup = Supply Voltage I = Loop Current

$$R_{\text{max}} = (V_{\text{sup}} - 10 \text{ V}) / 20 \text{ mA}$$

Rain Detector Time Period Transfer Function

Formula 4

$$T = [(I - 4\text{mA}) / 16] \times 80 \text{ minutes}$$

OPERATION:

Operation will commence when power is applied to the Transmitter. The output signal is initialized to 4 mA when operating power is applied or when the reset switch (R) on Switch 1 is moved to ON and then OFF.

Ramp Mode

Select by moving switch 2 to off position. The loop current from the Transmitter in ramp mode increases in a staircase like manner, 1% for each .01 inch of rain. See Figure 7. When 1 inch of rainfall is accumulated (output signal is 20 mA), the output resets to 4 mA. Thus each step in the current represents 1/100 inch of rainfall.

Rain Detector Mode

Select by moving switch 2 to on position. This mode is intended to provide a signal to inhibit a machine or process when rain is detected. Each tip of the rain gage bucket causes the transmitter to output full scale output for a period of time from 1 to 80 minutes. The timer is retriggerable so that a new time period begins at each tip of the bucket. See Figure 8, Figure 9 and calibration instructions for adjusting time period.

GAIN AND ZERO ADJUSTMENTS

Gain & Zero are set using switch 1. See Figure 3. Settings are stored in EEPROM and are retained when power is removed. Adjust Zero first to produce 4.08 mA output (0.5% of full scale). After Zero is set input 99 switch closures and adjust the Gain (Span) to produce 19.92 mA (99.5% of full scale). Follow instructions exactly or settings may not be stored permanently.

Switch 1 Controls:

- 1 Set output to Full Scale
- 2 Ramp / One Shot Mode
- 3 Set One One Shot Time Period
 - U 4 Increase Parameter
 - D 5 Decrease Parameter
 - Z 6 Select Zero Adjust
 - G 7 Select Gain Adjust
- R 8 Reset

Gain Adjust:

- 1. Move R to ON
- 2. Move U to ON
- 3. Move D to ON
- 4. Move R to OFF
- 5. Move U to OFF
- 6. Move D to OFF
- 7. Move SW 1 to ON

- 10. Move G to ON
- 11. Move U or D ON & OFF as required
- 12. Move U or D to OFF
- 13. Move G to OFF
- 14. Move SW 1 to OFF

Zero Adjust:

- 1. Move R to ON
- 2. Move U to ON
- 3. Move D to ON
- 4. Move R to OFF
- 5. Move U to OFF
- 6. Move D to OFF
- 7. Move Z to ON
- 8. Move U or D ON & OFF as required9.
- Move U or D to OFF
- 10. Move Z to OFF.

One Shot Time Period Adjust:

- 1. Move R to ON
- 2. Move U to ON

- 3. Move D to ON
- 4. Move R to OFF
- 5. Move U to OFF
- 6. Move D to OFF
- 7. Move SW 3 to ON
- 8. Move U or D ON & OFF as required
- 9. Move U or D to OFF
- 10. Move SW3 to OFF

NOTE:

Normal program execution is suspended while parameters are stored.

Allow ten seconds for output to stabilize after final step of calibration.

Switch 1 loads the rainfall counter to assist in calibration.

Closing Switch 1 loads 99 bucket tips.

MAINTENANCE:

Rain Gauge

Check that the screen, bucket assembly and drainage holes are free of debris. The bucket and inner funnel should be carefully wiped clean.

Every six months the two bucket pivot points should be lubricated with a drop of light oil.

Once a year check that the gauge is level and adjust if necessary.



CALIBRATION:

The rain gauge has been calibrated at the factory.

- 1. Wet Rain Gauge surfaces
- 2. Refer to Table 2. Pour water into gauge at rate of approximately 0.5 ml / second.
- 3. Check that bucket tips within +2 as averaged over 5 tips of the bucket.

Re-Calibration

- 1. Release the 4 locknuts on the calibration screws that the bucket rests on.
- 2. Wet all gauge surfaces and empty excess water from bucket.
- 3. Refer to Table 2 and using a flow rate of 0.5 ml /second drip water through the funne, noting how much water it takes to tip the bucket.
- 4. If the bucket tips too soon, adjust the screws downward. If the bucket tips too late, adjust them upward.
- 5. When the required calibration is obtained tighten all locknuts simultaneously.
- 6. Verify calibration as above.

CALIBRATION VOLUME

Table 2

Units of Calibration	Volume of Water
0.2 mm	6.48 ml
0.25 mm	8.11 ml
0.5 mm	16.215 ml
0.01 inch	8.24 ml

TROUBLESHOOTING:

Effective trouble shooting requires that problem locations be systematically eliminated until the problem is found. There are four basic questions to answer when trouble shooting (Ref. #1):

- 1. Did it ever work right?
- 2. What are the symptoms that tell you it's not working right?
- 3. When did it start working badly or stop working?
- 4. What other symptoms showed up just before, just after, or at the same time as the failure?

It is best to write down any clues you may obtain. Be sure to write down anything unusual.

The response to question #3 should probably not be 3:04 P.M.. A useful response might be, "Just after an electrical storm." or, "Just after it fell off the shelf." Double check all the simple solutions to the problem before searching for complex ones. If the problem occurs right after installation, it probably has a simple solution. If an automobile engine cranks, but doesn't start, make sure there is fuel in the tank before replacing the engine. If the electronic equipment doesn't function verify that it has power and is turned on.

Systems containing parts which can be quickly interchanged are easy to trouble shoot. Swap parts until the problem moves. The location has then been narrowed to the part that caused the problem to move. Sometimes there are multiple problems. These reveal themselves in layers much like peeling an onion.

It often helps to explain the problem to another person, even if that person is not knowledgeable about the particular piece of equipment. This does two things. First it requires you to organize the situation so it can be explained to another. Secondly, it may turn out that you are so familiar with the situation that you have overlooked the obvious. Another person unfamiliar with the equipment may be able to help. If you are unable to solve the problem, put it aside until the next day. Some new thoughts will probably occur while working on another project.

References

1. "Troubleshooting is More Effective with the Right Philosophy", Robert A. Pease, Electronic Design News, January 5, 1989.

TROUBLESHOOTING:

(Continued)

No Rainfall Recorded:

All Switches in S1 must be in OFF position.

Debris in gauge

Failed Switch in Gauge -Use ohm meter to check resistance as bucket is slowly tipped by hand. Meter should indicate infinite resistance when bucket is at rest. It should indicate 1 - 10 ohms when the switch is closed.

Broken Signal Cable - Ohm meter will indicate only infinite resistance.



Failure of Electronics in Transmitter - Disconnect signal cable. Use a switch or short piece of wire to momentarily connect the two terminals on the Transmitter circuit board at two second intervals. This will simulate pulses from the rain gauge. If the output of the Transmitter fails to respond, return the Transmitter to the factory for repair.

Excessive Precipitation:

Check that the gage orifice is level.

General Electrical Problems:

Loop Current:

0 mA

< 4 mA

> 20 mA

Does not reach 20 mA, otherwise operates properly

Failure Description:

Current loop polarity reversed

Op
en
cir
cui
t
in
ca
bl
e
Po
we
r
su
pp

ly
fail
ur
e

Low power supply voltage
Loop

resi

stan

ce

too

hig

h

Sho

rt

circ

uit

in



A70-RLX

Rainfall Transmitter

cabl

e

Low power supply voltage

L
o
o
p
r
e
s
i
s
t
a
n
c
e
t
o
o
h
i
g
h