

FLUKE®

— Hart Scientific®

914X Series
*Field Metrology Well
User's Guide*

Revision 7A1901-EN

Limited Warranty & Limitation of Liability

Each product from Fluke Corporation, Hart Scientific Division (“Hart”) is warranted to be free from defects in material and workmanship under normal use and service. The warranty period is one year for Field Metrology Wells. The warranty period begins on the date of the shipment. Parts, product repairs, and services are warranted for 90 days. The warranty extends only to the original buyer or end-user customer of a Hart authorized reseller, and does not apply to fuses, disposable batteries or to any other product, which in Hart’s opinion, has been misused, altered, neglected, or damaged by accident or abnormal conditions of operation or handling. Hart warrants that software will operate substantially in accordance with its functional specifications for 90 days and that it has been properly recorded on non-defective media. Hart does not warrant that software will be error free or operate without interruption. Hart does not warrant calibrations on the Field Metrology Well.

Hart authorized resellers shall extend this warranty on new and unused products to end-user customers only but have no authority to extend a greater or different warranty on behalf of Hart. Warranty support is available if product is purchased through a Hart authorized sales outlet or Buyer has paid the applicable international price. Hart reserves the right to invoice Buyer for importation costs of repairs/replacement parts when product purchased in one country is submitted for repair in another country.

Hart’s warranty obligation is limited, at Hart’s option, to refund of the purchase price, free of charge repair, or replacement of a defective product which is returned to a Hart authorized service center within the warranty period.

To obtain warranty service, contact your nearest Hart authorized service center or send the product, with a description of the difficulty, postage, and insurance prepaid (FOB Destination), to the nearest Hart authorized service center. Hart assumes no risk for damage in transit. Following warranty repair, the product will be returned to Buyer, transportation prepaid (FOB Destination). If Hart determines that the failure was caused by misuse, alteration, accident or abnormal condition or operation or handling, Hart will provide an estimate or repair costs and obtain authorization before commencing the work. Following repair, the product will be returned to the Buyer transportation prepaid and the Buyer will be billed for the repair and return transportation charges (FOB Shipping Point).

THIS WARRANTY IS BUYER’S SOLE AND EXCLUSIVE REMEDY AND IS IN LIEU OF ALL OTHER WARRANTIES, EXPRESS OR IMPLIED, INCLUDING BUT NOT LIMITED TO ANY IMPLIED WARRANTY OF MERCHANTABILITY OR FITNESS FOR A PARTICULAR PURPOSE. HART SHALL NOT BE LIABLE FOR ANY SPECIAL, INDIRECT, INCIDENTAL OR CONSEQUENTIAL DAMAGES OR LOSSES, INCLUDING LOSS OF DATA, WHETHER ARISING FROM BREACH OF WARRANTY OR BASED ON CONTRACT, TORT, RELIANCE OR ANY OTHER THEORY.

Since some countries or states do not allow limitation of the term of an implied warranty, or exclusion or limitation of incidental or consequential damages, the limitations and exclusions of this warranty may not apply to every buyer. If any provision of this Warranty is held invalid or unenforceable by a court of competent jurisdiction, such holding will not affect the validity or enforceability of any other provision.

Specifications subject to change without notice. • Copyright © 2007 • Printed in USA

Table of Contents

1	Before You Start	1
1.1	Introduction	1
1.2	Unpacking	2
1.3	Symbols Used.....	3
1.4	Safety Information.....	4
1.4.1	Warnings	5
1.4.2	Cautions	7
1.5	CE Comments.....	8
1.5.1	EMC Directive	8
1.5.2	Immunity Testing	8
1.5.3	Emission Testing.....	9
1.5.4	Low Voltage Directive (Safety)	9
1.6	Authorized Service Centers.....	9
2	Specifications and Environmental Conditions.....	13
2.1	Specifications	13
2.2	Environmental Conditions	15
3	Quick Start.....	17
3.1	Setup.....	17
3.2	Parts and Controls	18
3.2.1	Display Panel	19
3.2.2	Display	20
3.2.3	Power Panel	22
3.2.4	-P Option Panel (-P models only).....	24
3.3	Languages.....	26
3.3.1	Language Selection	26
3.3.2	Reset to English Language	27
4	Menu Structure.....	29
4.1	Temp Setup Menu.....	29
4.2	Prog Menu	30
4.2.1	Switch Test Parameters.....	31
4.2.2	Switch Test Description	31
4.3	System Menu	33
4.4	Input Setup (-P only).....	34

5 Maintenance35
5.1 Field Metrology Well Performance Analysis 35

Tables

Table 1 Symbols used..... 3
Table 2 Base Unit Specifications 13
Table 3 -P Option Specifications 14

Figures

Figure 1 Clamp-on ferrite installation.....	9
Figure 2 914X Field Metrology Well	18
Figure 3 Display panel and keys	20
Figure 4 914X display	21
Figure 5 9142 power panel.....	23
Figure 6 9143 and 9144 power panel.....	23
Figure 7 -P option panel	24
Figure 8 Probe connector wiring	25
Figure 9 Jumper locations for 3-wire and 2-wire connections.....	26
Figure 10 Steps to language selection	27
Figure 11 Main Menu - Temp SetUp	29
Figure 12 Main Menu - Prog Menu	30
Figure 13 Auto and manual switch test operation example	32
Figure 14 Main Menu - System Menu	33
Figure 15 Main Menu - Input Setup	34

1 Before You Start

1.1 Introduction

Field Metrology Wells (9142, 9143, and 9144) are designed to be reliable, stable heat sources that can be used in the field or laboratory. They offer accuracy, portability, and speed for nearly every field calibration application. The instruments have been designed with the field user in mind and are easy to use while maintaining stability, uniformity, and accuracy comparable to some laboratory instruments.

Special built-in features make Field Metrology Wells extremely adaptable. The exclusive Voltage Compensation allows the technician to plug into mains power with voltage from 90 V ac to 250 V ac without degradation to the instrument. The Ambient Temperature Compensation (Patent Pending) provides the largest operating range in the industry (0°C to 50°C) with the largest guaranteed temperature range (13°C to 33°C). The Gradient Temperature Compensation (Patent Pending) keeps the axial gradient within specification over the entire temperature range of the instrument and over the specified guaranteed operating temperature range. These combined features along with the rugged design, light weight, and small size make this line of instruments ideal for field applications.

Unique Patent Pending safety features make these the safest field heat sources available. The unique Air Flow Design (Patent Pending) keeps the probe handle cool protecting delicate instruments and the user. The Block Temperature Indicator (Patent Pending) shows the user when the well temperature is above 50°C letting the user know when it is safe to remove the insert or move the instrument. The indicator light illuminates when the instrument is energized and the well is above 50°C. If the instrument is removed from mains power, the indicator light flashes until the well has cooled to less than 50°C.

The optional “Process” version (“914X-P”) combines the heat source with a built-in readout eliminating the need for the technician to take two instruments to the field. The readout is perfect for transmitter loop, comparison calibration, or a simple check of a thermocouple sensor. There is no need to carry additional tools into the field with the “Process” option of a built-in readout for resistance, voltage, and mA measurement, 24V loop power, and on-board documentation. The convenient smart reference connector automatically transfers and stores the probe coefficients.

The Field Metrology Wells’ controller uses a PRT sensor and thermoelectric modules or heaters to achieve stable, uniform temperatures throughout the block.

The LCD display continuously shows many useful operating parameters including the block temperature, the current set-point, block stability, and heating and cooling status. For the Process version, the reference temperature and secondary input type (UUT) readings are displayed. The display can be set to show the information in one of eight different languages; English, Japanese, Chinese, German, Spanish, French, Russian, and Italian.

The instrument’s rugged design and special features make them ideal for the field or the laboratory. With proper use, the instrument provides continued accurate calibration of temperature

914X Field Metrology Wells

Unpacking

sensors and devices. Before use, the user should be familiar with the warnings, cautions, and operating procedures of the calibrator as described in the User's Guide.

1.2 Unpacking

Unpack the instrument carefully and inspect it for any damage that may have occurred during shipment. If there is shipping damage, notify the carrier immediately.

Verify that the following components are present:

9142

- 9142 Field Metrology Well
- 9142-INSX Insert (X=A, B, C, D, E, or F)
- Power Cord
- RS-232 Cable
- User Guide
- Technical Manual CD
- Report of Calibration and calibration label
- 6-pin DIN Connector (-P model only)
- Test Lead Kit (-P model only)
- Well Insulator
- Clamp-on ferrites (3) [-P model only]
- Tongs (insert removal tool)
- 9930 Interface-it Software and User's Guide

9143

- 9143 Field Metrology Well
- 9143-INSX Insert (X=A, B, C, D, E, or F)
- Power Cord
- RS-232 Cable
- User Guide
- Technical Manual CD
- Report of Calibration and calibration label
- 6-pin DIN Connector (-P model only)
- Test Lead Kit (-P model only)
- Clamp-on ferrites (3) [-P model only]
- Tongs (insert removal tool)
- 9930 Interface-it Software and User's Guide

9144







- 9144 Field Metrology Well
- 9144-INSX Insert (X=A, B, C, D, E, or F)
- Power Cord
- RS-232 Cable
- User Guide
- Technical Manual CD
- Report of Calibration and calibration label
- 6-pin DIN Connector (-P model only)
- Test Lead Kit (-P model only)
- Clamp-on ferrites (3) [-P model only]
- Tongs (insert removal tool)
- 9930 Interface-it Software and User's Guide

If all items are not present, contact an Authorized Service Center (see Section 1.6 Authorized Service Centers on page 9).

1.3 Symbols Used











Table 1 lists the International Electrical Symbols. Some or all of these symbols may be used on the instrument or in this guide.

Table 1 Symbols used

Symbol	Description
	AC (Alternating Current)
	AC-DC
	Battery
	Complies with European Union directives
	DC
	Double Insulated

914X Field Metrology Wells

Safety Information

Symbol	Description
	Electric Shock
	Fuse
	PE Ground
	Hot Surface (Burn Hazard)
	Read the User's Guide (Important Information)
	Off
	On
	Canadian Standards Association
	C-TICK Australian EMC mark
	The European Waste Electrical and Electronic Equipment (WEEE) Directive (2002/96/EC) mark.

1.4 Safety Information

Field Metrology Wells are designed in accordance with IEC 61010-1, IEC 61010-2-010 and CAN/CSA 22.2 No 61010.1-04. Use this instrument only as specified in this manual. Otherwise, the protection provided by the instrument may be impaired. Refer to the safety information in the Warnings and Cautions sections below.

The following definitions apply to the terms “Warning” and “Caution”.

- “Warning” identifies conditions and actions that may pose hazards to the user.
- “Caution” identifies conditions and actions that may damage the instrument being used.

1.4.1 Warnings

To avoid personal injury, follow these guidelines.

GENERAL

DO NOT use this instrument in environments other than those listed in the User's Guide.

Inspect the instrument for damage before each use. Inspect the case. Look for cracks or missing plastic. **DO NOT** use the instrument if it appears damaged or operates abnormally.

Follow all safety guidelines listed in the User's Guide.

Calibration equipment should only be used by trained personnel.

If this equipment is used in a manner not specified by the manufacturer, the protection provided by the equipment may be impaired.

Before initial use, or after transport, or after storage in humid or semi-humid environments, or anytime the instrument has not been energized for more than 10 days, the instrument needs to be energized for a "dry-out" period of 2 hours before it can be assumed to meet all of the safety requirements of the IEC 1010-2. If the product is wet or has been in a wet environment, take necessary measures to remove moisture prior to applying power such as storage in a low humidity temperature chamber operating at 50°C for 4 hours or more.

DO NOT use this instrument for any application other than calibration work. The instrument was designed for temperature calibration. Any other use of the instrument may cause unknown hazards to the user.

DO NOT place the instrument under a cabinet or other structure. Overhead clearance is required. Always leave enough clearance to allow for safe and easy insertion and removal of probes.

Use of this instrument at HIGH TEMPERATURES for extended periods of time requires caution.

Completely unattended high temperature operation is not recommended due to safety hazards that can arise.

This instrument is intended for indoor use only.

Follow all safety procedures for the test and calibration equipment you use.

If used, inspect the test leads for damaged insulation or exposed metal. Check for test lead continuity. Replace damaged test leads as necessary.

Do not use the instrument if it operates abnormally. Protection may be impaired. When in doubt, have the instrument serviced.

Do not apply more than the rated voltage, as marked on the instrument, between terminals or between any terminal and earth ground.

914X Field Metrology Wells

Safety Information

Never touch the probes to a voltage source when the test leads are plugged into the current terminals.

Select the proper function and range for each measurement.

Disconnect the test leads before changing to another measure or source function.

DO NOT operate the Field Metrology Well around explosive gas, vapor, or dust.

DO NOT operate instrument at orientations other than upright. Tilting the instrument or laying it down on its side during use could create a fire hazard.

BURN HAZARD

The instrument is equipped with a Block Temperature Indicator (front panel LED HOT indicator – Patent Pending) even when the instrument is unplugged. When the indicator is flashing, the instrument is disconnected from mains power and the temperature of the block is above 50°C. When the indicator is illuminated, always on, the instrument is powered and the block temperature is above 50°C.

DO NOT turn the instrument upside down with the inserts in place; the inserts will fall out.

DO NOT operate near flammable materials.

Use of this instrument at HIGH TEMPERATURES for extended periods of time requires caution.

DO NOT touch the well access surface of the instrument.

The block vent may be very hot due to the fan blowing across the heater block of the instrument.

The temperature of the well access is the same as the actual display temperature, e.g. if the instrument is set to 600°C and the display reads 600°C, the well is at 600°C.

Probes and inserts may be hot and should only be inserted and removed from the instrument when the instrument indicates temperatures less than 50°C.

DO NOT turn off the instrument at temperatures higher than 100°C. This could create a hazardous situation. Select a set-point less than 100°C and allow the instrument to cool before turning it off.

The high temperatures present in Field Metrology Wells designed for operation at 300°C and higher may result in fires and severe burns if safety precautions are not observed.

ELECTRICAL HAZARD

These guidelines must be followed to ensure that the safety mechanisms in this instrument operate properly. This instrument must be plugged into an AC only electric outlet according to Table 2, Specifications. The power cord of the instrument is equipped with a three-pronged grounding plug for your protection against electrical shock hazards. It must be plugged directly into a properly grounded three-prong receptacle. The receptacle must be installed in accordance with local codes and ordinances. Consult a qualified electrician. **DO NOT** use an extension cord or adapter plug.

If supplied with user accessible fuses, always replace the fuse with one of the same rating, voltage, and type.

Always replace the power cord with an approved cord of the correct rating and type.

HIGH VOLTAGE is used in the operation of this equipment. SEVERE INJURY or DEATH may result if personnel fail to observe safety precautions. Before working inside the equipment, turn power off and disconnect power cord.

-P Model Only

When using test leads, keep fingers behind the finger guards on the test leads.

DO NOT apply more than the rated voltage, as marked on the instrument, between the terminals, or between any terminal and earth ground (30 V 24 mA max all terminals).

Never touch the probe to a voltage source when the test leads are plugged into current terminals.

Select the proper function and range for your measurement.

Inspect the test leads for damaged insulation or exposed metal. Check test leads continuity. Replace damaged test leads before you use the calibrator.

1.4.2 Cautions

To avoid possible damage to the instrument, follow these guidelines:

DO NOT leave the inserts in the instrument for prolonged periods. Due to the high operating temperatures of the instrument, the inserts should be removed after each use and buffed with a Scotch-Brite® pad or emery cloth (see Section 5 Maintenance on page 35).

Always operate this instrument at room temperature between 41°F and 122°F (5°C to 50°C). Allow sufficient air circulation by leaving at least 6 inches (15 cm) of clearance around the instrument. Overhead clearance of 1 meter (3 ft) is required. **DO NOT** place instrument under any structure.

Component lifetime can be shortened by continuous high temperature operation.

DO NOT apply any type of voltage to the display hold terminals. Applying a voltage to the terminals may cause damage to the controller.

DO NOT use fluids to clean out the well. Fluids could leak into electronics and damage the instrument.

Never introduce any foreign material into the probe hole of the insert. Fluids, etc. can leak into the instrument causing damage.

Unless recalibrating the instrument **DO NOT** change the values of the calibration constants from the factory set values. The correct setting of these parameters is important to the safety and proper operation of the calibrator.

914X Field Metrology Wells

CE Comments

DO NOT allow the probe sheath or inserts to drop into the well. This type of action can cause a shock to the sensor and affect the calibration.

The instrument and any thermometer probes used with it are sensitive instruments that can be easily damaged. Always handle these devices with care. **DO NOT** allow them to be dropped, struck, stressed, or overheated.

DO NOT operate this instrument in an excessively wet, oily, dusty, or dirty environment. Always keep the well and inserts clean and clear of foreign material.

The Field Metrology Well is a precision instrument. Although it has been designed for optimum durability and trouble free operation, it must be handled with care. Always carry the instrument in an upright position to prevent the inserts from dropping out. The convenient handle allows for hand carrying the instrument.

If a mains supply power fluctuation occurs, immediately turn off the instrument. Power bumps from brown-outs could damage the instrument. Wait until the power has stabilized before re-energizing the instrument.

The probe and the block may expand at different rates. Allow for probe expansion inside the well as the block heats. Otherwise, the probe may become stuck in the well.

Most probes have handle temperature limits. If the probe handle limits are exceeded, the probe may be permanently damaged. Due to a unique Air Flow Design (Patent Pending), Field Metrology Wells protect the probe handle temperature and provide a safer temperature handle for the user.

1.5 CE Comments

1.5.1 EMC Directive

Hart Scientific's equipment has been tested to meet the European Electromagnetic Compatibility Directive (EMC Directive, 89/336/EEC). The Declaration of Conformity for your instrument lists the specific standards to which the instrument was tested.

The instrument was designed specifically as a test and measuring device. Compliance to the EMC directive is through IEC 61326-1 Electrical equipment for measurement, control and laboratory use.

As noted in the IEC 61326-1, the instrument can have varying configurations. The instrument was tested in a typical configuration with shielded RS-232 cables.

1.5.2 Immunity Testing

Using Clamp-On Ferrites

For the -P model only, clamp-on ferrites are provided for use in improving its electromagnetic (EM) immunity in environments of excessive EM interference. During EMC testing we found that ferrites clamped around probe cables for the Reference PRT, the PRT/RTD input, and the thermocouple (TC) input reduced the risk the EM interference affects measurements. Therefore,

we recommend that the clamp-on ferrites provided be used on the cables of probes attached to the readout, especially if the product is used near sources of EM interference such as heavy industrial equipment.

To attach a ferrite to a probe cable, make a loop in the cable near the connector and clamp the ferrite around half of the loop as shown in the diagram. The ferrite can be easily snapped open and moved to a new probe when needed.

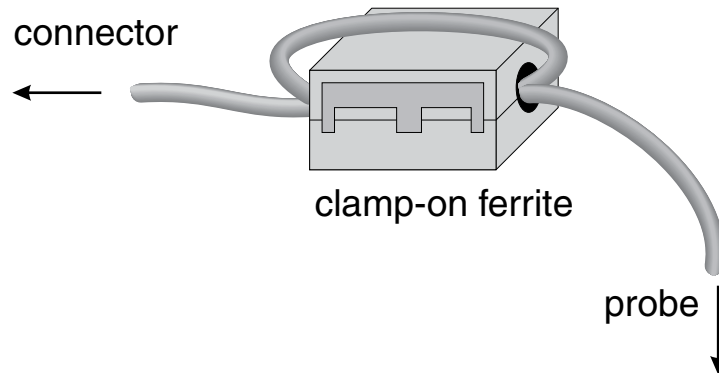

Figure 1 Clamp-on ferrite installation

1.5.3 Emission Testing

The instrument fulfills the limit requirements for Class A equipment. The instrument was not designed to be used in domestic establishments.

1.5.4 Low Voltage Directive (Safety)

In order to comply with the European Low Voltage Directive (2006/95/EC), Hart Scientific equipment has been designed to meet the EN 61010-1 and the EN 61010-2-010 standards.

1.6 Authorized Service Centers

Please contact one of the following Authorized Service Centers to coordinate service on your Hart product:

914X Field Metrology Wells

Authorized Service Centers

When contacting a Service Centers for support, please have the following information available:

- Model Number
- Serial Number
- Voltage
- Complete description of the problem



2 Specifications and Environmental Conditions

2.1 Specifications

Table 2 Base Unit Specifications

Base Unit Specifications			
	9142	9143	9144
Temperature Range at 23 °C	-25 °C to 150 °C (-13 °F to 302 °F)	33 °C to 350 °C (91 °F to 662 °F)	50 °C to 660 °C (122 °F to 1220 °F)
Display Accuracy	± 0.2 °C Full Range	± 0.2 °C Full Range	± 0.35 °C at 50 °C ± 0.35 °C at 420 °C ± 0.5 °C at 660 °C
Stability	± 0.01 °C Full Range	± 0.02 °C at 33 °C ± 0.02 °C at 200 °C ± 0.03 °C at 350 °C	± 0.03 °C at 50 °C ± 0.05 °C at 420 °C ± 0.05 °C at 660 °C
Axial Uniformity at 40 mm (1.6 in)	± 0.05 °C Full Range	± 0.04 °C at 33 °C ± 0.1 °C at 200 °C ± 0.2 °C at 350 °C	± 0.05 °C at 50 °C ± 0.35 °C at 420 °C ± 0.5 °C at 660 °C
Axial Uniformity at 60 mm (2.4 in)	± 0.07 °C Full Range	± 0.04 °C at 33 °C ± 0.2 °C at 200 °C ± 0.25 °C at 350 °C	± 0.1 °C at 50 °C ± 0.6 °C at 420 °C ± 0.8 °C at 660 °C
Radial Uniformity	± 0.01 °C Full Range	± 0.01 °C at 33 °C ± 0.015 °C at 200 °C ± 0.02 °C at 350 °C	± 0.02 °C at 50 °C ± 0.05 °C at 420 °C ± 0.1 °C at 660 °C
Loading Effect (with a 6.35 mm reference probe and three 6.35 mm probes)	± 0.006 °C Full Range	± 0.015 °C Full Range	± 0.015 °C at 50 °C ± 0.025 °C at 420 °C ± 0.035 °C at 660 °C
Loading Effect (versus display with 6.35 mm probes)	± 0.08 °C Full Range	± 0.2 °C Full Range	± 0.1 °C at 50 °C ± 0.2 °C at 420 °C ± 0.2 °C at 660 °C
Hysteresis	0.025 °C	0.03 °C	0.1 °C
Operating Conditions	0 °C to 50 °C, 0 % to 90 % RH (non-condensing)		
Environmental conditions for all specifications except temperature range	13 °C to 33 °C		
Immersion (Well) Depth	150 mm (5.9 in)		
Insert OD	30 mm (1.18 in)	25.3 mm (1.00 in)	24.4 mm (0.96 in)
Heating Time	16 min: 23 °C to 140 °C 23 min: 23 °C to 150 °C 25 min: -25 °C to 150 °C	5 min: 33 °C to 350 °C	15 min: 50 °C to 660 °C
Cooling Time	15 min: 23 °C to -25 °C 25 min: 150 °C to -23 °C	32 min: 350 °C to 33 °C 14 min: 350 °C to 100 °C	35 min: 660 °C to 50 °C 25 min: 660 °C to 100 °C
Resolution	0.01 °		
Display	LCD, °C or °F user-selectable		
Key Pad	Arrows, Menu, Enter, Exit, 4 soft keys		
Size (H x W x D)	290 mm x 185 mm x 295 mm (11.4 x 7.3 x 11.6 in)		

914X Field Metrology Wells

Specifications

Base Unit Specifications			
	9142	9143	9144
Weight	8.16 kg (18 lbs)	7.3 kg (16 lbs)	7.7 kg (17 lbs)
Power Requirements	100 V to 115 V ($\pm 10\%$) 50/60 Hz, 635 W 230 V ($\pm 10\%$) 50/60 Hz, 575 W	100 V to 115 V ($\pm 10\%$), 50/60 Hz, 1400 W 230 V ($\pm 10\%$), 50/60 Hz, 1800 W	
System Fuse Ratings	115 V: 6.3 A T 250 V 230 V: 3.15 A T 250 V	115 V: 15 A F 250 V 230 V: 10 A F 250 V	
4–20 mA Fuse (-P model only)	50 mA F 250V		
Computer Interface	RS-232 and 9930 Interface-it control software included		
Safety	EN 61010-1:2001, CAN/CSA C22.2 No. 61010.1-04		

Table 3 -P Option Specifications

-P Specifications	
Built-in Reference Thermometer Readout Accuracy (4-Wire Reference Probe)[†]	$\pm 0.013\text{ }^{\circ}\text{C}$ at $-25\text{ }^{\circ}\text{C}$ $\pm 0.015\text{ }^{\circ}\text{C}$ at $0\text{ }^{\circ}\text{C}$ $\pm 0.020\text{ }^{\circ}\text{C}$ at $50\text{ }^{\circ}\text{C}$ $\pm 0.025\text{ }^{\circ}\text{C}$ at $150\text{ }^{\circ}\text{C}$ $\pm 0.030\text{ }^{\circ}\text{C}$ at $200\text{ }^{\circ}\text{C}$ $\pm 0.040\text{ }^{\circ}\text{C}$ at $350\text{ }^{\circ}\text{C}$ $\pm 0.050\text{ }^{\circ}\text{C}$ at $420\text{ }^{\circ}\text{C}$ $\pm 0.070\text{ }^{\circ}\text{C}$ at $660\text{ }^{\circ}\text{C}$
Reference Resistance Range	0 ohms to 400 ohms
Reference Resistance Accuracy[‡]	0 ohms to 42 ohms: ± 0.0025 ohms 42 ohms to 400 ohms: ± 60 ppm of reading
Reference Characterizations	ITS-90, CVD, IEC-751, Resistance
Reference Measurement Capability	4-wire
Reference Probe Connection	6 Pin Din with Infocon Technology
Built-in RTD Thermometer Readout Accuracy	NI-120: $\pm 0.015\text{ }^{\circ}\text{C}$ at $0\text{ }^{\circ}\text{C}$ PT-100 (385): $\pm 0.02\text{ }^{\circ}\text{C}$ at $0\text{ }^{\circ}\text{C}$ PT-100 (3926): $\pm 0.02\text{ }^{\circ}\text{C}$ at $0\text{ }^{\circ}\text{C}$ PT-100 (JIS): $\pm 0.02\text{ }^{\circ}\text{C}$ at $0\text{ }^{\circ}\text{C}$
RTD Resistance Range	0 ohms to 400 ohms
Resistance Accuracy[‡]	0 ohms to 25 ohms: ± 0.002 ohms 25 ohms to 400 ohms: ± 80 ppm of reading
RTD Characterizations	PT-100 (385),(JIS),(3926), NI-120, Resistance
RTD Measurement Capability	2-,3-,4-wire RTD w/ Jumpers only
RTD Connection	4 terminal input

Specifications and Environmental Conditions

Environmental Conditions

-P Specifications	
Built-in TC Thermometer Readout Accuracy	Type J: ± 0.7 °C at 660 °C Type K: ± 0.8 °C at 660 °C Type T: ± 0.8 °C at 400 °C Type E: ± 0.7 °C at 660 °C Type R: ± 1.4 °C at 660 °C Type S: ± 1.5 °C at 660 °C Type M: ± 0.6 °C at 660 °C Type L: ± 0.7 °C at 660 °C Type U: ± 0.75 °C at 600 °C Type N: ± 0.9 °C at 660 °C Type C: ± 1.1 °C at 660 °C
TC Millivolt Range	-10 mV to 75 mV
Voltage Accuracy	0.025 % of reading +0.01mV
Internal Cold Junction Compensation Accuracy	± 0.35 °C (ambient of 13 °C to 33 °C)
TC Connection	Small connectors
Built-in mA Readout Accuracy	0.02% of reading + 0.002 mA
mA Range	Cal 4-22 mA, Spec 4-24 mA
mA Connection	2 terminal input
Loop Power Function	24 VDC loop power
Built-in Electronics Temperature Coefficient (0 °C to 13 °C, 33 °C to 50 °C)	± 0.005 % of range per °C
<p>¹The temperature range may be limited by the reference probe connected to the readout. The Built-In Reference Accuracy does not include the sensor probe accuracy. It does not include the probe uncertainty or probe characterization errors.</p> <p>²Measurement accuracy specifications apply within the operating range and assume 4-wires for PRTs. With 3-wire RTDs add 0.05 ohms to the measurement accuracy plus the maximum possible difference between the resistances of the lead wires.</p>	

2.2 Environmental Conditions

Although the instrument has been designed for optimum durability and trouble-free operation, it must be handled with care. The instrument should not be operated in an excessively dusty or dirty environment. Maintenance and cleaning recommendations can be found in the Maintenance section. The instrument operates safely under the following environmental conditions:

- ambient temperature range: 0-50°C (32-122°F)
- ambient relative humidity: 0 % to 90 % (non-condensing)
- mains voltage: within ±10% of nominal
- vibrations in the calibration environment should be minimized
- altitude: less than 2,000 meters
- indoor use only

3 Quick Start

3.1 Setup



Note: The instrument will not heat, cool, or control until the “SET PT.” parameter is “Enabled”.

Place the calibrator on a flat surface with at least 6 inches of free space around the instrument. Overhead clearance is required. **DO NOT** place under a cabinet or structure.

Plug the instrument power cord into a mains outlet of the proper voltage, frequency, and current capability (see Section 2.1 Specifications on page 13 for power details). Observe that the nominal voltage corresponds to that indicated on the front of the calibrator.

Carefully place the insert into the well. Inserts should be of the smallest hole diameter possible still allowing the probe to slide in and out easily. Various insert sizes are available. Contact an Authorized Service Center for assistance (see Section 1.6 Authorized Service Centers on page 9). The well must be clear of any foreign objects, dirt and grit before an insert is installed. The insert is installed with the two small tong holes positioned upward.

Turn on the power to the calibrator by toggling the switch on the power entry module. After a brief self-test, the controller should begin normal operation. The main screen appears within 30 seconds. If the instrument fails to operate, please check the power connection. The display shows the well temperature, and waits for user input before further operation.

Press “SET PT.” and use the arrow keys to set the desired set-point temperature. Press “ENTER” to save the desired set-point and enable the instrument. After five (5) seconds, the instrument should start to operate normally and heat or cool to the designated set-point.

914X Field Metrology Wells

Parts and Controls



Figure 2 914X Field Metrology Well

3.2 Parts and Controls

This section describes the exterior features of the Field Metrology Well. All interface and power connections are found on the front of the instrument (see Figure 2).

3.2.1 Display Panel

Figure 3 on next page shows the layout of the display panel.

Display (1)

The display is a 240 x 160 pixel monochrome graphics LCD device with a bright LED back-light. The display is used to show current control temperature, measurements, status information, operating parameters, and soft key functions.

▲▼◀▶ Arrow Keys (2)

The Arrow Keys allow you to move the cursor on the display, change the display layout, and adjust the contrast of the display. The contrast can only be adjusted using the ▲ and ▼ arrow keys while viewing the main display window.

Enter Key (3)

The Enter Key allows you to select menus and accept new values.

SET PT. (4)

The Set Pt. Key allows you to enable the instrument to heat or cool to a desired set-point. Until this key is enabled, the instrument will not heat or cool. It is in a “sleep” state for safety of the operator and instrument.

°C/°F Key (5)

The °C/°F Key allows you to change the displayed temperature units from °C to °F and vice versa.

Menu Key (6)

The Menu Key allows the user to access all parameter and settings menus. From the main menu, the user can use the soft keys to access submenus and functions.

Exit Key (7)

The Exit Key allows you to exit menus and cancel newly entered values.

Soft Keys (8)

The Soft Keys are the four buttons immediately below the display (labeled F1 to F4). The functions of the soft keys are indicated on the display above the buttons. The function of the keys may change depending on the menu or function that is selected.

Switch Connector (9)

The switch hold connector posts are located on the left side of the display panel.

914X Field Metrology Wells

Parts and Controls

Block Temperature Indicator (10) [Patent Pending]

The Block Temperature Indicator lamp allows users to know when the block temperature is safe (50°C to 60°C) to remove inserts or move the Field Metrology Well. The indicator light is lit continuously once the block has exceeded approximately 50°C (varies 50°C to 60°C). The indicator light stays lit until the block cools to less than approximately 50°C. If the instrument is disconnected from mains power, the indicator light flashes until the block temperature is less than approximately 50°C.



Figure 3 Display panel and keys

3.2.2 Display

The front panel display is shown in detail in Figure 4 on opposite page.

Heat Source Temperature (1)

The most recent block temperature measurement is shown in large digits in the box at the top of the screen.

Set-point Temperature (2)

The current set-point temperature is displayed just below the Process Temperature.

Reference Thermometer Temperature (3) [-P models only]

When installed, the most recent reference thermometer measurement is shown on the screen.

Stability Status (4)

On the right hand side of the screen, you will find a graph displaying the current status of the stability of the Field Metrology Well.

Heating/Cooling Status (5)

Just below the stability graph there is a bar graph that will indicate HEATING, COOLING, or CUTOUT. This status graph indicates the current level of heating or cooling if the instrument is not in cutout mode.

UUT Output (6) [-P models only]

When installed, the most recent UUT output measurement is shown. The value displayed depends on the output type selected: mA, RTD, or TC.

Soft Key Functions (7)

The four texts at the bottom of the display (not shown) indicate the functions of the soft keys (F1–F4). These functions change with each menu.

Editing Windows

While setting up and operating the instrument, you are often required to enter or select parameters. Editing windows appear on the screen when necessary to show the values of parameters and allow edits.

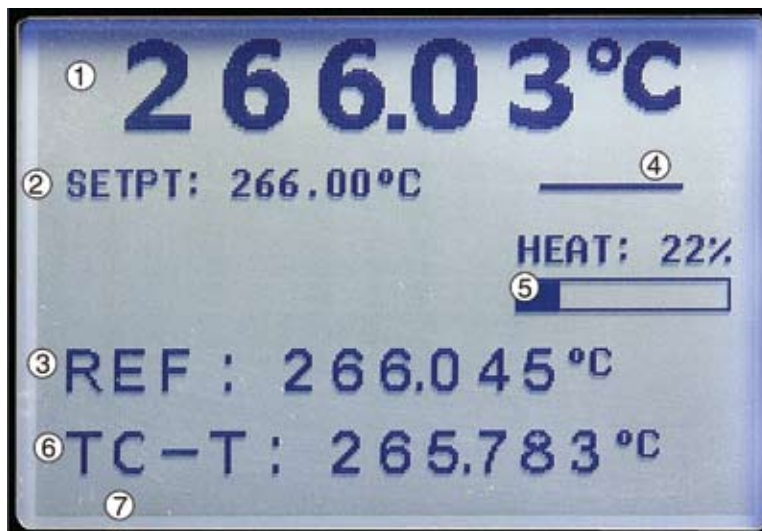

Figure 4 914X display

914X Field Metrology Wells

Parts and Controls

3.2.3 Power Panel

The following are found on the lower front panel of the instrument (see Figures 5 and Figure 6 on opposite page).

Power Cord Plug (1)

The power supply cord attaches to the lower front power panel. Plug the cord into an AC mains supply appropriate for the voltage range as specified in the specifications tables.

Power Switch (2)

For the 9142, the power switch is located on the power entry module of the unit at the lower center of the power panel.

For the 9143 and 9144, the power switch is located between the RS-232 and the fuses.

Serial Connector (3)

On the 9142, the serial connector is a 9-pin subminiature D type located on the power panel above the power entry module. On the 9143 and 9144, the serial connector is a 9-pin subminiature D type located on the power panel to the left of the power switch. The serial (RS-232) interface can be used to transmit measurements and control the operation of the instrument.

Fuses (4)

For the 9142, the fuses are located inside the power entry module of the unit (Figure 5 on opposite page).

For the 9143 and 9144, the fuses are separate from the power connector (Figure 6 on opposite page).

If necessary, fuses must be replaced according to Specifications (see Section 2.1 Specifications on page 13).

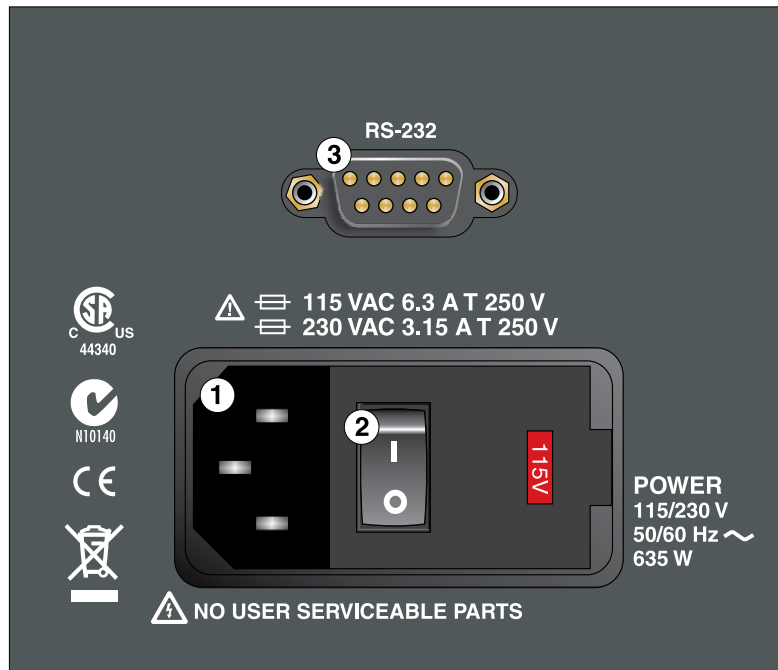

Figure 5 9142 power panel

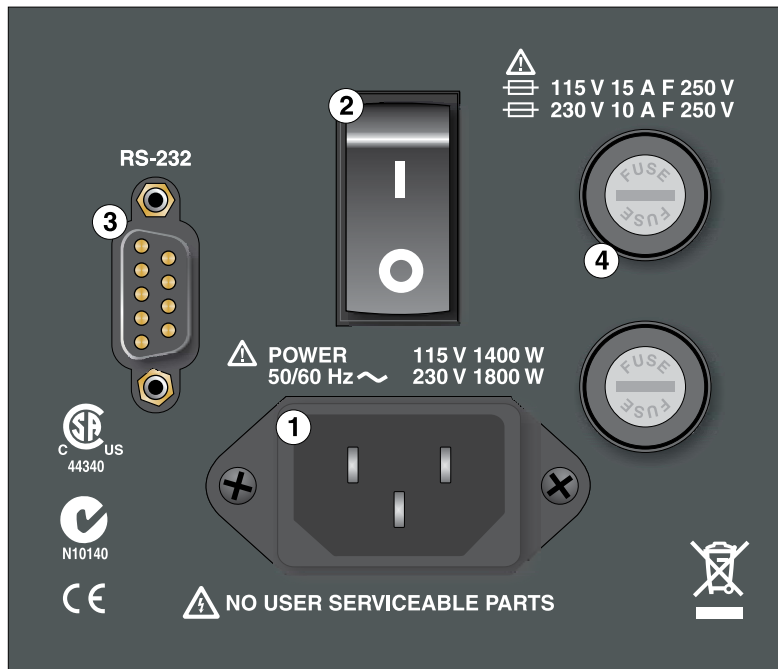

Figure 6 9143 and 9144 power panel

914X Field Metrology Wells

Parts and Controls

3.2.4 -P Option Panel (-P models only)

The -P (process version) panel is the readout portion of the instrument and is only available with -P models.

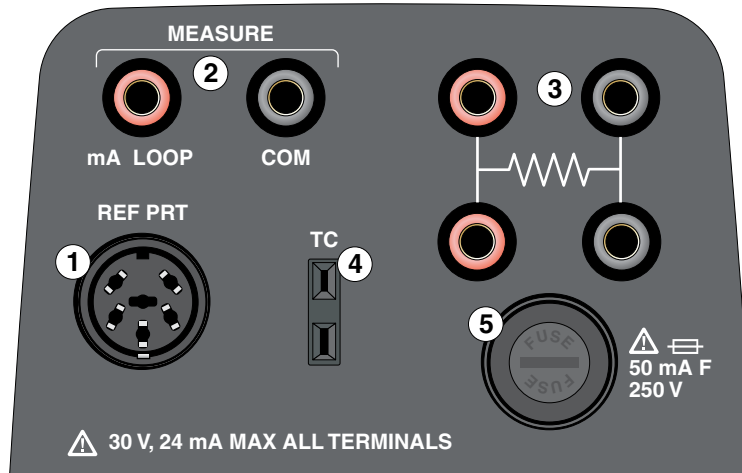

Figure 7 -P option panel

Reference Thermometer Connection (1)

The 6-pin DIN smart connector on the front panel allows a reference probe to be attached to the instrument for use with the reference thermometer function of the instrument. The smart connector stores probe calibration coefficients. The 6-pin DIN accepts traditional connectors and the probe coefficients can be entered into the readout or an appropriate characterization curve can be selected through the user interface (see Section 1.5.2 Immunity Testing on page 8 for information on using clamp-on ferrites).

A PRT is the only type of probe that is supported by the reference thermometer input. The PRT (RTD or SPRT) probe connects to the reference thermometer input using a 6-pin DIN connector. Figure 8 shows how a four-wire probe is wired to the 6-pin DIN connector. One pair of wires attaches to pins 1 and 2 and the other pair attaches to pins 4 and 5 (pins 1 and 5 source current and pins 2 and 4 sense the potential). If a shield wire is present, it should be connected to pin 3, which is also used for the memory circuit. Pin 6 is only used for the memory circuit.

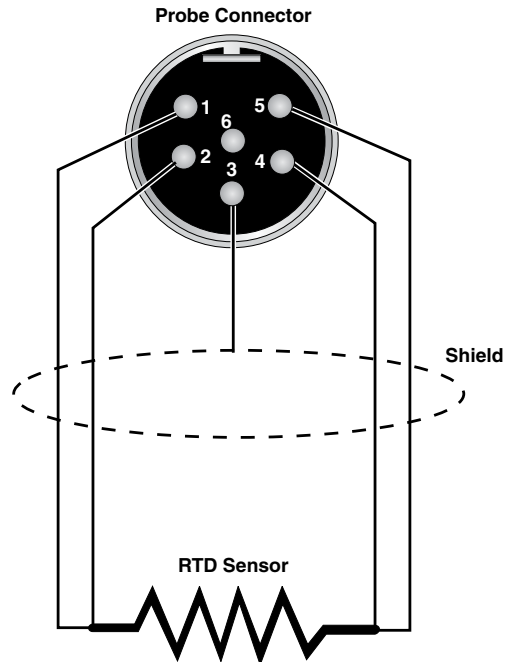

Figure 8 Probe connector wiring

A two-wire probe can also be used with the reference thermometer. It is connected by attaching one wire to both pins 1 and 2 of the plug and the other wire to both pins 4 and 5. If a shield wire is present, it should be connected to pin 3. Accuracy may be significantly degraded using a two-wire connection because of lead resistance.

4-20mA Connectors (2)

The 4-20mA connectors allow current and/or voltage probes to be connected for measurement of associated devices.

PRT/RTD Connector (3)

The 4-wire PRT/RTD connectors allow the user to connect 3-wire and 2-wire (with jumpers, see Figure 9 on next page) PRT/RTDs to the readout. The correct wiring for the 4-wire PRT/RTD is shown on the instrument. Figure 9 shows the correct wiring for a 2 or 3-wire PRT/RTD (see Section 1.5.2 Immunity Testing on page 8 for information on using clamp-on ferrites).

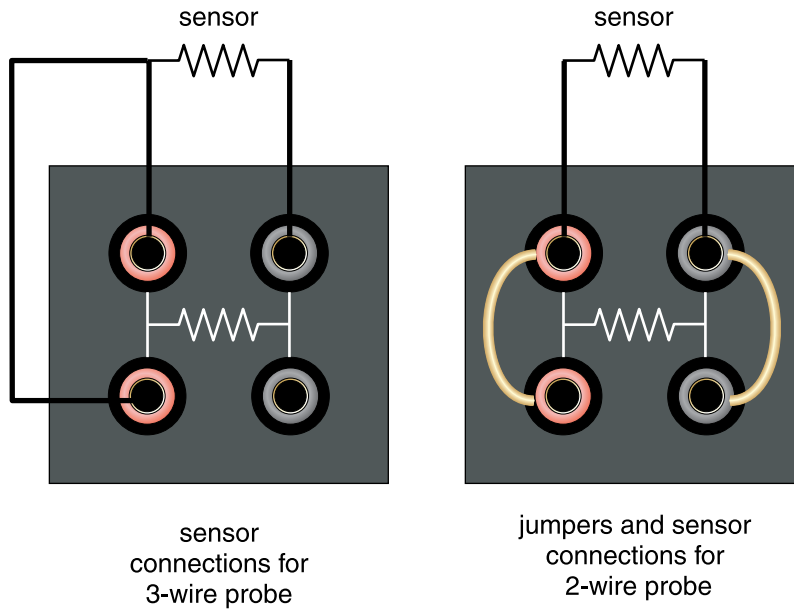

Figure 9 Jumper locations for 3-wire and 2-wire connections

Thermocouple (TC) Connector (4)

The TC connector allows for the use of subminiature TC connectors (see CE Comments on page 8 for information on using clamp-on ferrites).

Fuse (5)

Fuse for the 4-20 mA circuit. Always replace with a fuse of the appropriate rating (see Section 2.1 Specifications on page 13).

3.3 Languages

The display on Field Metrology Wells can be set to different languages depending on the configuration.

- European: English, French, Spanish, Italian, German
- Russian: Russian, English
- Asian: English, Chinese, Japanese

3.3.1 Language Selection

Select the language to be displayed by following the steps shown in Figure 10 on opposite page.

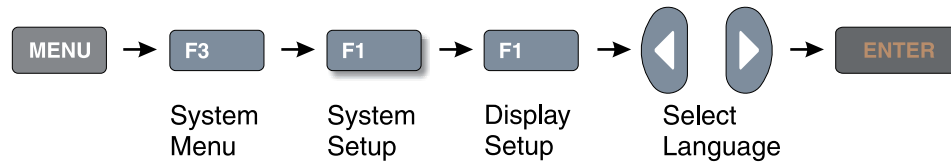

Figure 10 Steps to language selection

3.3.2 Reset to English Language

If you are in a language and need a short cut exit, press F1 and F4 simultaneously to reset the display to English.

To reset to your originally selected language after resetting to English, follow the steps in Figure 10 on this page.



Note: The F1 and F4 English shortcut override is temporary. If you toggle the power off, the instrument will return to the language selected in the DISPLAY SETUP menu rather than coming up in English.

4 Menu Structure

4.1 Temp Setup Menu

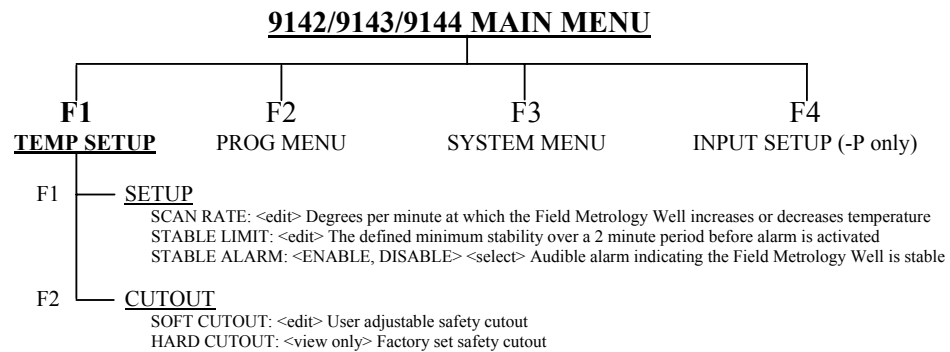

Hot Keys (while viewing main screen)

SETPOINT Key - **SETPOINT**
 SETPOINT: <edit> Set point temperature
 ENTER <enable control of the instrument>
 F1 - SELECT PRESET <1-8> <select>
 F1 - EDIT PRESET <1-8> <edit>
 F4 - SAVE/DISABLE <disables control of instrument>

°C / °F Key - Units: <°C, °F> Changes temperature units

Up/Down Arrow Keys <toggle> <adjust contrast>
 Up Key: Darker
 Down Key: Lighter

F1 & F4 Keys (same time) <reset display language to English>

F1 & F3 Keys (same time) <enable/disable key press beep>
 1 Beep - Valid key entry
 2 Beep - Invalid key entry

Code Update Mode Keys

ENTER & EXIT Keys (hold during power up) <initiate code update mode> Allows instrument software to be updated

Figure 11 Main Menu - Temp SetUp

914X Field Metrology Wells

Prog Menu

4.2 Prog Menu

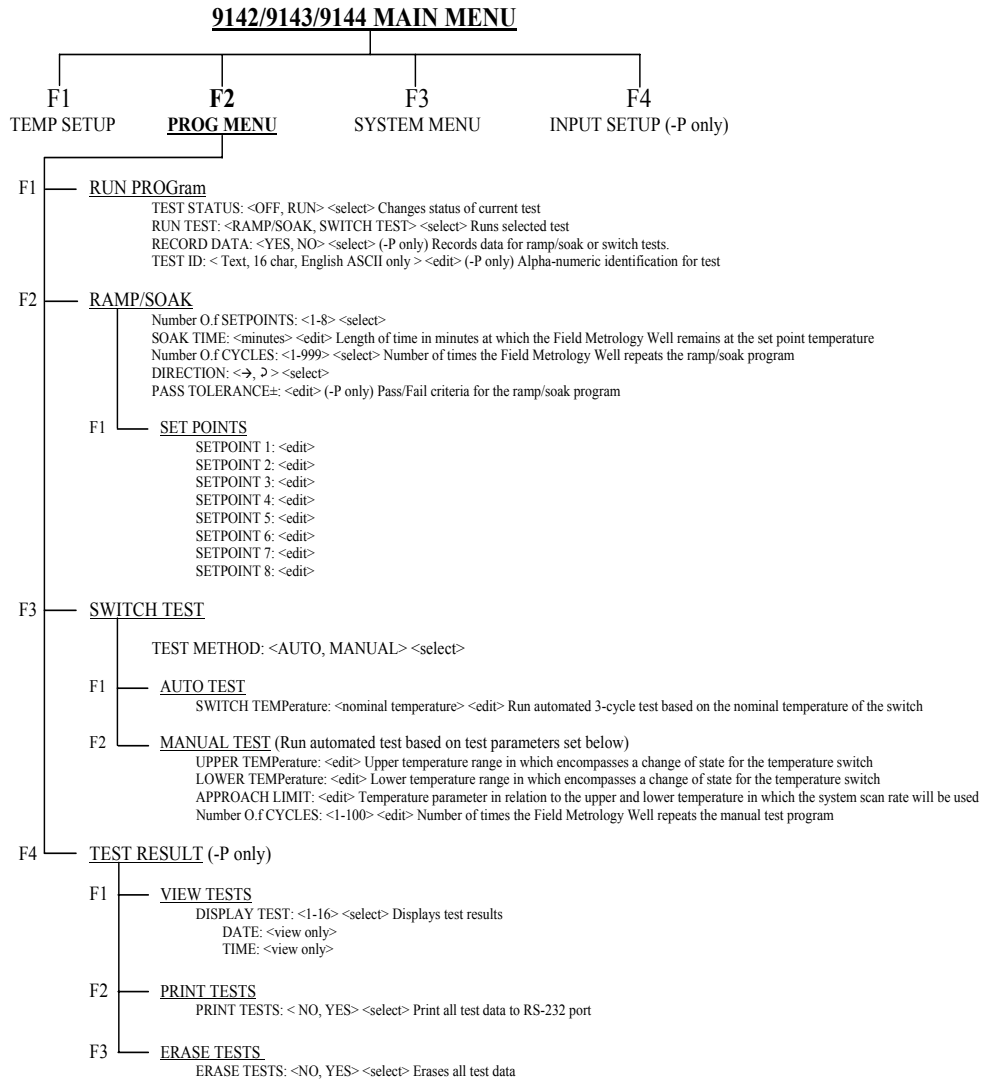

Figure 12 Main Menu - Prog Menu

4.2.1 Switch Test Parameters

SWITCH TEMP

The SWITCH TEMP parameter is the nominal change temperature of the switch.

UPPER TEMP

The UPPER TEMP parameter is the temperature during a cycle at which the Field Metrology Well begins to heat or cool at the rate specified in “Scan Rate” found in MAIN MENU|TEMP SETUP|SETUP|SCAN RATE.

LOWER TEMP

The LOWER TEMP parameter is the temperature at which the Field Metrology Well heats or cools, in order to begin testing if the test is just starting or the temperature at which the instrument begins to heat to start a cycle.

APPROACH

The APPROACH parameter controls the use of the Scan Rate during the approach to the set-point. During the test, the controller uses the system Scan Rate until the temperature is within the approach temperature of either the high temp or low temp parameters.

NO. CYCLES

The NO. CYCLES parameter determines how many times the instrument heats and cools allowing a thermal switch or batch of switches to be tested.

4.2.2 Switch Test Description



CAUTION: *The switch, switch wires, switch components and switch accessories can be damaged if the Field Metrology Well exceeds their temperature limits.*

The SWITCH TEST is used to select, set up, execute and view the results of switch tests. The Switch Test function allows thermal switches to be tested for open and/or close temperatures. The Switch Test allows for Auto or Manual operation. Figure 13 on next page shows a graphical representation of how a switch test works.

For Auto operation, enter the Prog Menu. Under Switch Test, select Auto Test. Enter the SWITCH TEMP. Set the Test Method to AUTO. Exit to the Run Prog menu. Ensure that Run Test is set to SWITCH TEST. Set Test Status to RUN. Press Enter and the instrument will engage and start the 3-cycle test within a few seconds. Exit to the main screen to view the test progress, refer to the Menu Structure.

For Manual operation, in the Temp Setup menu, select Setup and enter the SCAN RATE. Exit to the Prog Menu. Under Switch Test, select Manual Test. Enter the UPPER TEMP, LOWER TEMP, APPROACH LIMIT, and NO. CYCLES parameters. Set the Test Method to MANUAL. Exit to the Run Prog menu. Ensure that the Run Test is set to SWITCH TEST. Set Test Status to

914X Field Metrology Wells

Prog Menu

RUN. Press Enter and the instrument will engage and start the test within a few seconds. Exit to the main screen to view the test progress, refer to the Menu Structure.

When the switch resets, the test completes and the values of the switch OPEN, switch CLOSE, and switch BAND are displayed for the user to record. The values may also be recorded internally in the instrument by selecting the option to record the data (-P model only).

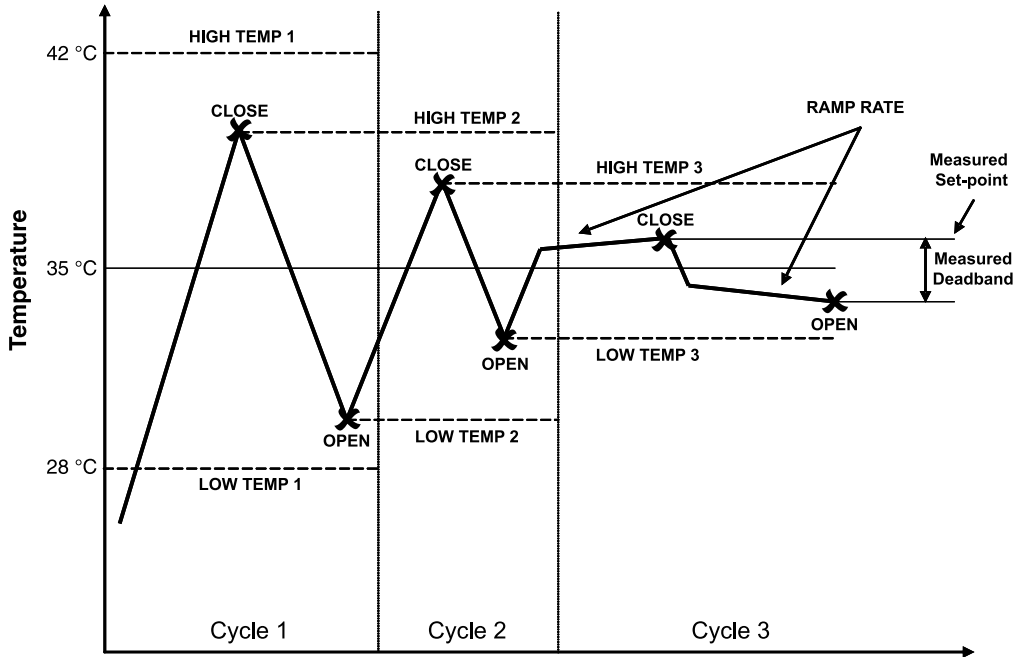

Figure 13 Auto and manual switch test operation example

4.3 System Menu

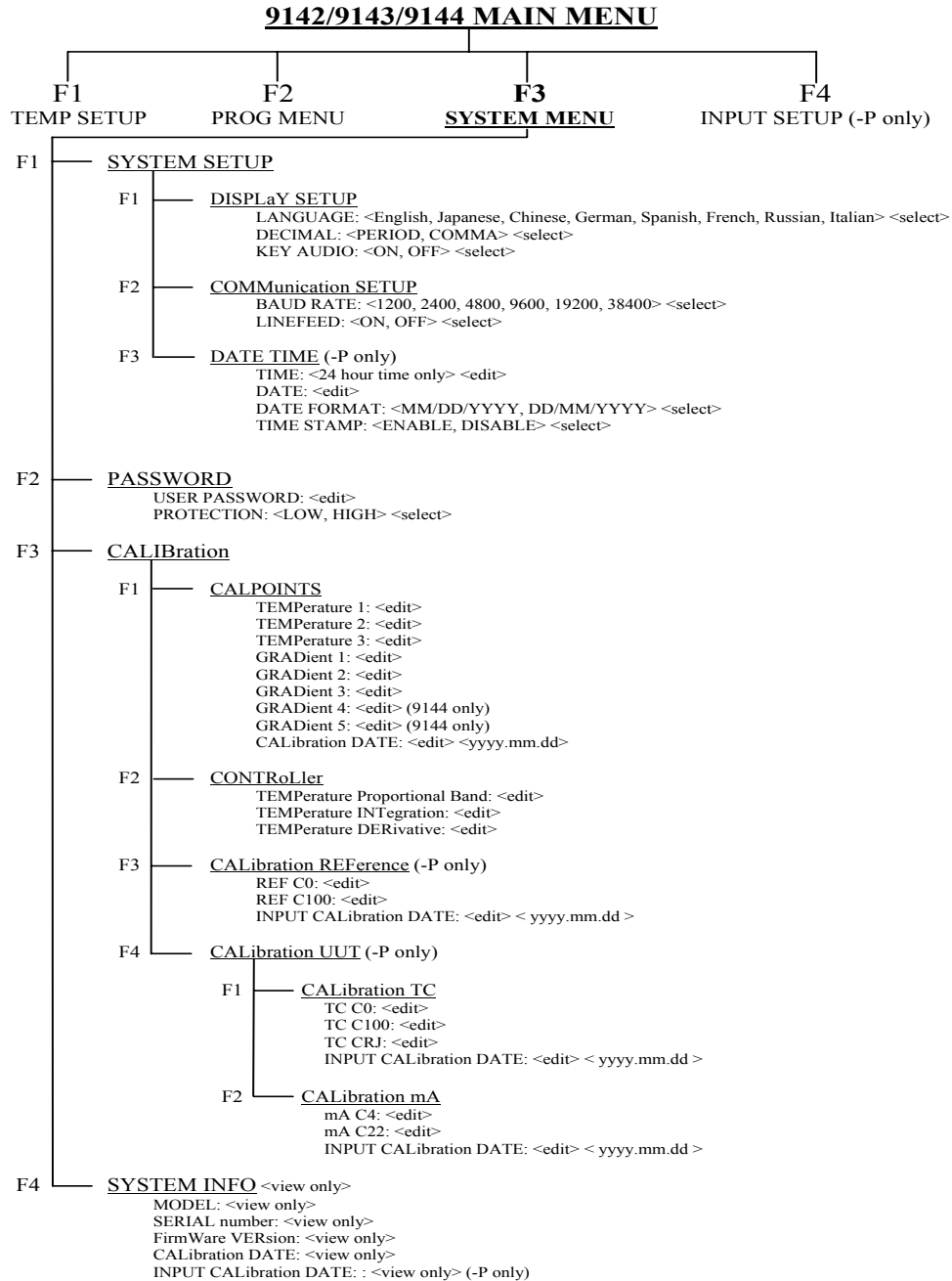

Figure 14 Main Menu - System Menu

914X Field Metrology Wells

Input Setup (-P only)

4.4 Input Setup (-P only)

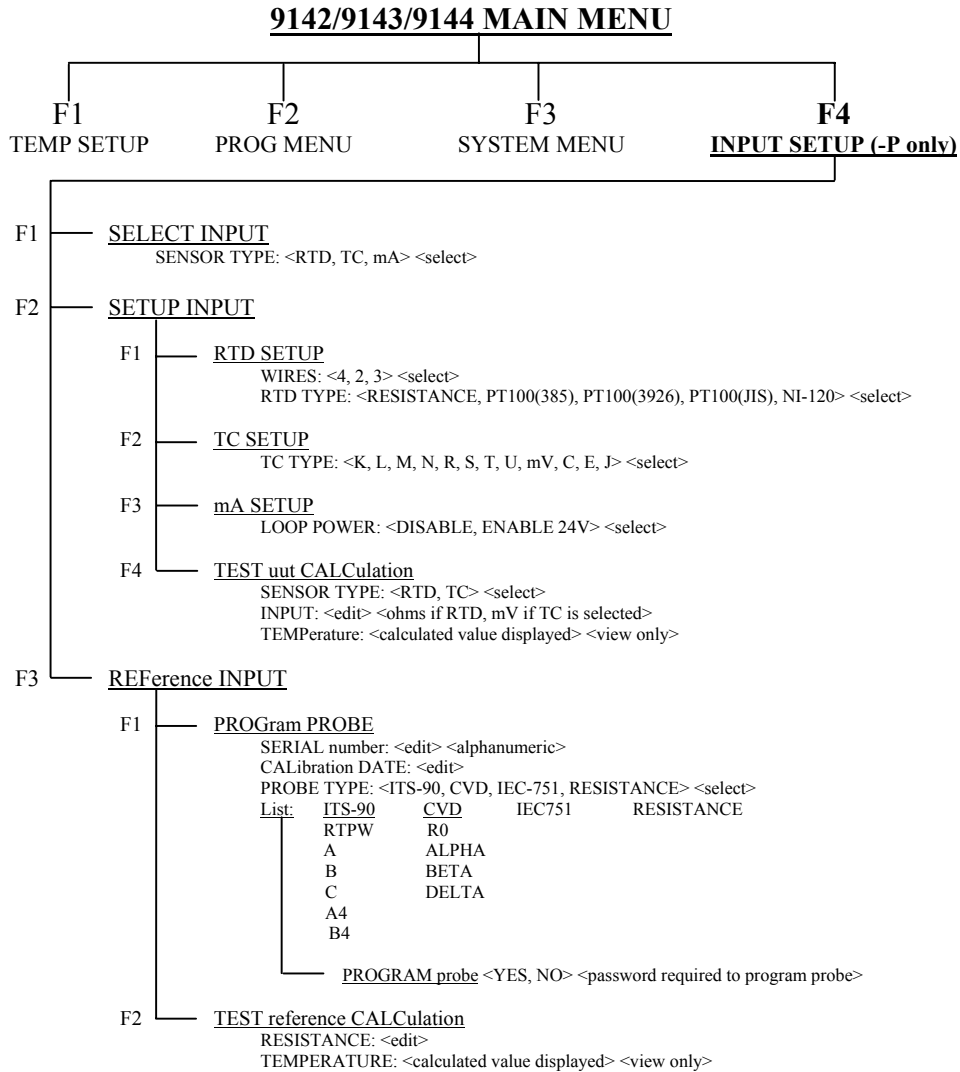

Figure 15 Main Menu - Input Setup

5 Maintenance

The Field Metrology Well has been designed with the utmost care. Ease of operation and simplicity of maintenance have been a central theme in the product development. With proper care, the instrument should require very little maintenance. Avoid operating the instrument in an oily, wet, dirty, or dusty environment. Operating the instrument in a draft-free environment facilitates improved performance of the instrument.

- If the outside of the instrument becomes soiled, it may be wiped clean with a damp cloth and mild detergent. Do not use harsh chemicals on the surface which may damage the paint or plastic.
- It is important to keep the well of the calibrator clean and clear of any foreign matter. **DO NOT** use fluid to clean out the well.
- The instrument should be handled with care. Avoid knocking or dropping the calibrator.
- The removable inserts can become covered with dust and carbon material. If the buildup becomes too thick, it could cause the inserts to become jammed in the wells. Avoid this buildup by periodically buffing the inserts clean.
- If an insert should be dropped, examine the insert for deformities before inserting it in the well. If there is any chance of jamming the insert in the well, file or grind off the protuberance.
- **DO NOT** allow the probe stems to drop into the well or harshly impact the well bottom. This type of action can cause a shock to the sensor.
- If a hazardous material is spilled on or inside the instrument, the user is responsible for taking the appropriate decontamination steps as outlined by the national safety council with respect to the material.
- If the mains supply cord becomes damaged, replace it with a cord of the appropriate gauge wire for the current of the instrument. If there are any questions, contact an Authorized Service Center for more information.
- Before using any cleaning or decontamination method, other than those recommended by Fluke's Hart Scientific Division, users should check with an Authorized Service Center to insure the proposed method will not damage the equipment.
- If the instrument is used in a manner not in accordance with the equipment design, the operation of the instrument may be impaired or safety hazards may arise.
- The over-temperature cutout should be checked every 6 months to see that it is working properly. In order to check the user selected cutout, follow the controller directions for setting the cutout. Set the instrument temperature higher than the cutout. Check to see if the display shows cutout and the temperature is decreasing.

5.1 Field Metrology Well Performance Analysis

For optimum performance and lowest possible uncertainty budgets, use the guidelines set forth below.

914X Field Metrology Wells

Field Metrology Well Performance Analysis

Accuracy Drift

The display temperature of the instrument will drift over time. This is due to a variety of factors affecting the temperature control PRT. Any PRT is subject to changes depending on how it is used and the environment it is used in. This is no different for any PRT in a calibration application. In addition, manufacturing variables in the sensing element itself can result in greater or lesser impact from use and environment. Oxidation and contamination from the sensor's environment will create changes requiring new calibration constants depending on the temperature range and normal operation of the instrument. Oxidation and contamination are generally not factors when Field Metrology Wells are used exclusively below 200°C. Oxidation can form in the body of the PRT platinum sensor wire in the range of 300 °C to 500 °C. Contamination is primarily a problem following prolonged use above 500°C. Additionally, vibration from handling or transportation will strain the delicate PRT element, changing its resistance. Some of this strain may come out by annealing at a slightly higher temperature than the instrument is typically used at. It is recommended to avoid unnecessary temperature cycling. Cycling the temperature up and down between minimum and maximum temperatures excessively may also cause strain on the PRT element.

Effects from control sensor drift may be avoided by using an external temperature reference. In the case that the calibration of the display value is required, a program of monitoring and recalibration must be implemented, just as with any calibration standard. Regularly check the accuracy of the Field Metrology Well with an adequate temperature reference and keep records as a part of your instrument maintenance routine. When the accuracy drifts to a point where it is no longer acceptable, then have the instrument recalibrated. Your records will provide data for determining a calibration interval appropriate for your history of use and accuracy requirements.

Stability

The stability specification of the Field Metrology Well was determined under laboratory conditions of steady ambient temperature and air flow. While this instrument has been designed to minimize ambient effects, they will still have some effect. For the best results, avoid quickly-changing ambient temperatures and drafty conditions.

Axial Uniformity

Field Metrology Well axial uniformity should be checked periodically. Use the process outlined in EA 10/13 or a similar process. If the axial uniformity has changed outside the limits set by the user's uncertainty budget, adjust the axial gradient as outlined in the Field Metrology Well Calibration section of the Field Metrology Well Technical Guide and recalibrate the Field Metrology Well.