

281, 282, 284

40 MS/s Arbitrary Waveform Generators

Users Manual

January 2005
© 2005 Fluke Corporation, All rights reserved. Printed in USA
All product names are trademarks of their respective companies.

LIMITED WARRANTY AND LIMITATION OF LIABILITY

Each Fluke product is warranted to be free from defects in material and workmanship under normal use and service. The warranty period is one year and begins on the date of shipment. Parts, product repairs, and services are warranted for 90 days. This warranty extends only to the original buyer or end-user customer of a Fluke authorized reseller, and does not apply to fuses, disposable batteries, or to any product which, in Fluke's opinion, has been misused, altered, neglected, contaminated, or damaged by accident or abnormal conditions of operation or handling. Fluke warrants that software will operate substantially in accordance with its functional specifications for 90 days and that it has been properly recorded on non-defective media. Fluke does not warrant that software will be error free or operate without interruption.

Fluke authorized resellers shall extend this warranty on new and unused products to end-user customers only but have no authority to extend a greater or different warranty on behalf of Fluke. Warranty support is available only if product is purchased through a Fluke authorized sales outlet or Buyer has paid the applicable international price. Fluke reserves the right to invoice Buyer for importation costs of repair/replacement parts when product purchased in one country is submitted for repair in another country.

Fluke's warranty obligation is limited, at Fluke's option, to refund of the purchase price, free of charge repair, or replacement of a defective product which is returned to a Fluke authorized service center within the warranty period.

To obtain warranty service, contact your nearest Fluke authorized service center to obtain return authorization information, then send the product to that service center, with a description of the difficulty, postage and insurance prepaid (FOB Destination). Fluke assumes no risk for damage in transit. Following warranty repair, the product will be returned to Buyer, transportation prepaid (FOB Destination). If Fluke determines that failure was caused by neglect, misuse, contamination, alteration, accident, or abnormal condition of operation or handling, including overvoltage failures caused by use outside the product's specified rating, or normal wear and tear of mechanical components, Fluke will provide an estimate of repair costs and obtain authorization before commencing the work. Following repair, the product will be returned to the Buyer transportation prepaid and the Buyer will be billed for the repair and return transportation charges (FOB Shipping Point).

THIS WARRANTY IS BUYER'S SOLE AND EXCLUSIVE REMEDY AND IS IN LIEU OF ALL OTHER WARRANTIES, EXPRESS OR IMPLIED, INCLUDING BUT NOT LIMITED TO ANY IMPLIED WARRANTY OF MERCHANTABILITY OR FITNESS FOR A PARTICULAR PURPOSE. FLUKE SHALL NOT BE LIABLE FOR ANY SPECIAL, INDIRECT, INCIDENTAL, OR CONSEQUENTIAL DAMAGES OR LOSSES, INCLUDING LOSS OF DATA, ARISING FROM ANY CAUSE OR THEORY.

Since some countries or states do not allow limitation of the term of an implied warranty, or exclusion or limitation of incidental or consequential damages, the limitations and exclusions of this warranty may not apply to every buyer. If any provision of this Warranty is held invalid or unenforceable by a court or other decision-maker of competent jurisdiction, such holding will not affect the validity or enforceability of any other provision.

11/99

Safety

This generator is a Safety Class I instrument according to IEC classification and has been designed to meet the requirements of EN61010-1 (Safety Requirements for Electrical Equipment for Measurement, Control and Laboratory Use). It is an Installation Category II instrument intended for operation from a normal single phase supply.

This instrument has been tested in accordance with EN61010-1 and has been supplied in a safe condition. This instruction manual contains some information and warnings which have to be followed by the user to ensure safe operation and to retain the instrument in a safe condition.

This instrument has been designed for indoor use in a Pollution Degree 2 environment in the temperature range 5 °C to 40 °C, 20 % - 80 % RH (non-condensing). It may occasionally be subjected to temperatures between +5 °C and -10 °C without degradation of its safety. Do not operate the instrument while condensation is present.

Use of this instrument in a manner not specified by these instructions may impair the safety protection provided. Do not operate the instrument outside its rated supply voltages or environmental range.

Warning

To avoid the possibility of electric shock:

- **This instrument must be earthed.**
- **Any interruption of the mains earth conductor inside or outside the instrument will make the instrument dangerous. Intentional interruption is prohibited. The protective action must not be negated by the use of an extension cord without a protective conductor.**
- **When the instrument is connected to its supply, terminals may be live and opening the covers or removal of parts (except those to which access can be gained by hand) is likely to expose live parts.**
- **Any adjustment, maintenance and repair of the opened instrument under voltage shall be avoided as far as possible and, if inevitable, shall be carried out only by a skilled person who is aware of the hazard involved.**
- **Make sure that only fuses with the required rated current and of the specified type are used for replacement. The use of makeshift fuses and the short-circuiting of fuse holders is prohibited.**

Caution

If the instrument is clearly defective, has been subject to mechanical damage, excessive moisture or chemical corrosion the safety protection may be impaired and the apparatus should be withdrawn from use and returned for checking and repair.







Note 

This instrument uses a Lithium button cell for non-volatile memory battery back-up. Typical battery life is 5 years. In the event of replacement becoming necessary, replace only with a cell of the correct type, a 3 V Li/MnO₂ 20 mm button cell type 2032. Do not mix with solid waste stream. Do not cut open, incinerate, expose to temperatures above 60 °C or attempt to recharge. Used batteries should be disposed of by a qualified recycler or hazardous materials handler. Contact your authorized Fluke Service Center for recycling information.

 **Caution**

Do not wet the instrument when cleaning it and in particular use only a soft dry cloth to clean the LCD window.

The following symbols are used on the instrument and in this manual:

-  **Caution** - refer to the accompanying documentation, incorrect operation may damage the instrument.
-  Terminal connected to chassis ground.
-  Mains supply OFF.
-  Mains supply ON.
-  Alternating current.
-  Warning - hazardous voltages may be present.

EMC Compliance

This instrument meets the requirements of the EMC Directive 89/336/EEC.

Compliance was demonstrated by meeting the test limits of the following standards:

Emissions

EN61326 (1998) EMC product standard for Electrical Equipment for Measurement, Control and Laboratory Use. Test limits used were:

- a) Radiated: Class B
- b) Conducted: Class B
- c) Harmonics: The instrument is Class A by product category.
EN61000-3-2 (2000) Class A

Immunity

EN61326 (1998) EMC product standard for Electrical Equipment for Measurement, Control and Laboratory Use. Test methods, limits and performance achieved were:

- a) EN61000-4-2 (1995)
Electrostatic Discharge: 4 kV air, 4 kV contact Performance A.
- b) EN61000-4-3 (1997)
Electromagnetic Field: 3 V/m, 80 % AM at 1 kHz Performance A.
- c) EN61000-4-11 (1994)
Voltage Interrupt: 1 cycle, 100 % Performance A.
- d) EN61000-4-4 (1995)
Fast Transient: 1 kV peak (ac line), 0.5 kV peak (signal lines and RS232/GPIB ports) Performance A.
- e) EN61000-4-5 (1995)
Surge: 0.5 kV (line to line), 1 kV (line to ground) Performance A.
- f) EN61000-4-6 (1996)
Conducted RF: 3 V, 80 % AM at 1kHz (AC line only; signal connections <3 m not tested) Performance A.

According to EN61326 the definitions of performance criteria are:

Performance criterion A: 'During test, normal performance within the specification limits.'

Performance criterion B: 'During test, temporary degradation or loss of function or performance which is self-recovering'.

Performance criterion C: 'During test, temporary degradation or loss of function or performance which requires operator intervention or system reset occurs.'

Cautions

To ensure continued compliance with the EMC directive the following precautions should be observed:

- a) connect the generator to other equipment using only high quality, double-screened cables.

b) after opening the case for any reason ensure that all signal and ground connections are remade correctly before replacing the cover. Always ensure all case screws are correctly refitted and tightened.

c) In the event of part replacement becoming necessary, only use components of an identical type. Refer to the Service Manual.

Table of Contents

Chapter	Title	Page
1	Introduction and Specifications.....	1-1
	Introduction.....	1-2
	Overview	1-2
	Features	1-2
	Specifications.....	1-4
	Waveforms	1-4
	Standard Waveforms.....	1-4
	Sine, Cosine, Haversine, Haver cosine	1-4
	Square.....	1-4
	Triangle	1-4
	Ramps and Sin(x)/x.....	1-4
	Pulse and Pulse Train	1-4
	Arbitrary	1-5
	Sequence	1-5
	Output Filter.....	1-5
	Operating Modes	1-5
	Triggered Burst	1-5
	Gated.....	1-6
	Sweep	1-6
	Tone Switching	1-6
	Trigger Generator.....	1-7
	Outputs	1-7
	Main Output	1-7
	Sync Out.....	1-7
	Cursor/Marker Out	1-8
	Inputs	1-8
	Trig In	1-8
	Modulation In.....	1-8
	Sum In	1-8
	Hold.....	1-8
	Ref Clock In/Out.....	1-8
	Inter-channel Operation.....	1-9
	Inter-channel Modulation.....	1-9
	Inter-channel Analog Summing	1-9
	Inter-channel Phase Locking.....	1-9

	Inter-channel Triggering	1-10
	Interfaces	1-10
	General	1-10
2	Installation	2-1
	Mains Operating Voltage	2-2
	Fuse	2-2
	Mains Lead	2-2
	Mounting	2-2
3	Connections	3-1
	Introduction	3-2
	Front Panel Connections	3-2
	MAIN OUT	3-2
	SYNC OUT	3-2
	TRIG IN	3-3
	SUM IN	3-3
	MODULATION IN	3-3
	Rear Panel Connections	3-3
	REF CLOCK IN/OUT	3-3
	HOLD IN	3-4
	CURSOR/MARKER OUT	3-4
	RS232	3-4
	GPIB (IEEE-488)	3-5
4	Initial Operation	4-1
	Introduction	4-2
	Initial Operation	4-2
	Switching On	4-2
	Display Contrast	4-2
	Keyboard	4-2
	Principles of Editing	4-3
	Principles of Operation	4-5
	Clock Synthesis Mode	4-5
	DDS Mode	4-6
5	Standard Waveform Operation	5-1
	Introduction	5-2
	Standard Waveform Operation	5-2
	Setting Generator Parameters	5-2
	Waveform Selection	5-2
	Frequency	5-2
	Amplitude	5-3
	DC Offset	5-4
	Warning and Error Messages	5-5
	SYNC Output	5-6
6	Sweep Operation	6-1
	Introduction	6-2
	Principles of Sweep Operation	6-2
	Connections for Sweep Operation	6-2
	Setting Sweep Parameters	6-3

	Sweep Range	6-3
	Sweep Time	6-4
	Sweep Type	6-4
	Manual Sweep	6-5
	Sweep Spacing.....	6-6
	Sweep Marker.....	6-6
	Sweep Hold	6-6
7	Triggered Burst and Gate	7-1
	Introduction.....	7-2
	Internal Trigger Generator.....	7-2
	External Trigger Input	7-3
	Adjacent Channel Trigger Output	7-3
	Triggered Burst	7-3
	Trigger Source	7-4
	Trigger Edge.....	7-4
	Burst Count.....	7-4
	Start Phase	7-5
	Manual Initialization of Inter-channel Triggering.....	7-5
	Gated Mode.....	7-6
	Gate Source	7-6
	Gate Polarity.....	7-6
	Start Phase	7-6
	Sync Out in Triggered Burst and Gated Mode	7-7
8	Tone Mode	8-1
	Introduction.....	8-2
	Tone Frequency	8-2
	Tone Type.....	8-2
	Tone Switching Source.....	8-3
	DTMF Testing with a Multi-Channel Generator	8-4
9	Arbitrary Waveform Generation	9-1
	Introduction.....	9-2
	Arb Waveform Terms	9-2
	Arb Waveform Creation and Modification – General Principles	9-2
	Selecting and Outputting Arbitrary Waveforms	9-3
	Creating New Waveforms.....	9-4
	Create Blank Waveform	9-4
	Create Waveform Copy	9-5
	Modifying Arbitrary Waveforms	9-6
	Waveform Edit Cursor	9-6
	Resize Waveform	9-6
	Rename Waveform.....	9-7
	Waveform Info	9-7
	Delete Waveform.....	9-8
	Edit Waveform	9-8
	Point Edit.....	9-9
	Line Edit.....	9-9
	Wave Insert.....	9-9
	Block Copy.....	9-10
	Waveform Amplitude	9-11
	Waveform Offset.....	9-11

	Wave Invert	9-12
	Position Markers.....	9-12
	Arbitrary Waveform Sequence	9-13
	Sequence Set-up	9-14
	Frequency and Amplitude Control with Arbitrary Waveforms	9-15
	Frequency	9-15
	Amplitude.....	9-16
	Sync Out Settings with Arbitrary Waveforms	9-16
	Waveform Hold in Arbitrary Mode	9-16
	Output Filter Setting	9-17
10	Pulse and Pulse-trains	10-1
	Introduction.....	10-2
	Pulse Set-up	10-2
	Pulse-Train Set-up	10-4
	Waveform Hold in Pulse and Pulse-Train Modes	10-6
11	Modulation	11-1
	Introduction.....	11-2
	External Modulation	11-2
	External VCA	11-2
	External SCM	11-3
	Internal Modulation	11-3
12	Sum.....	12-1
	Introduction.....	12-2
	External Sum.....	12-2
	Internal Sum.....	12-3
13	Synchronization	13-1
	Introduction.....	13-2
	Inter-Channel Synchronization	13-2
	Synchronizing Principles.....	13-2
	Master-Slave Allocation.....	13-2
	Phase-setting between Channels.....	13-3
	Other Phase-Locking Considerations	13-4
	Synchronizing Two Generators	13-5
	Synchronizing Principles.....	13-5
	Connections for Synchronization	13-5
	Generator Set-ups	13-5
	Synchronizing.....	13-7
14	System Operations from the Utility Menu	14-1
	Introduction.....	14-2
	Storing and Recalling Set-ups.....	14-2
	Channel Waveform Information	14-2
	Warnings and Error messages.....	14-3
	Remote Interface Set-up	14-3
	Reference Clock In/Out Setting	14-3
	Cursor/Marker Output.....	14-3
	Power On Setting	14-4
	System Information.....	14-4

	Calibration	14-5
	Copying Channel Set-ups	14-5
15	Calibration.....	15-1
	Introduction.....	15-2
	Equipment Required	15-2
	Calibration Procedure	15-2
	Setting the Password.....	15-2
	Password Access to Calibration	15-3
	Changing the Password	15-3
	Calibration Routine.....	15-3
	Remote Calibration	15-5
16	Remote Operation	16-1
	Introduction.....	16-2
	Address and Baud Rate Selection	16-2
	Remote/Local Operation.....	16-2
	RS232 Interface	16-3
	RS232 Interface Connector	16-3
	Single Instrument RS232 Connections.....	16-3
	Addressable RS232 Connections.....	16-3
	RS232 Character Set.....	16-4
	Addressable RS232 Interface Control Codes	16-4
	Full List of Addressable RS232 Interface Control Codes.....	16-6
	GPIB Interface	16-6
	GPIB Subsets.....	16-6
	GPIB IEEE Std. 488.2 Error Handling.....	16-6
	GPIB Parallel Poll	16-7
	Status Reporting.....	16-7
	Standard Event Status and Standard Event Status Enable Registers.....	16-7
	Status Byte Register and Service Request Enable Register.....	16-8
	Power on Settings	16-9
	Remote Commands.....	16-10
	RS232 Remote Command Formats.....	16-10
	GPIB Remote Command Formats.....	16-10
	Command List	16-11
	Channel Selection.....	16-11
	Frequency and Period	16-12
	Amplitude and DC Offset.....	16-12
	Waveform Selection	16-12
	Arbitrary Waveform Create and Delete.....	16-13
	Arbitrary Waveform Editing	16-14
	Waveform Sequence Control	16-17
	Mode Commands.....	16-17
	Input/Output control	16-18
	Modulation Commands	16-19
	Phase Locking Commands	16-19
	Status Commands	16-19
	Miscellaneous Commands.....	16-21
	Remote Command Summary	16-22
17	Maintenance.....	17-1
	Introduction.....	17-2

Cleaning 17-2

Appendices

A Mains Operating Voltage A-1
B Warning and Error Messages B-1
C SYNC OUT Automatic Settings C-1
D Factory System Defaults D-1
E Waveform Manager Plus E-1
F Block Diagrams F-1
G Front and Rear Panel Drawings G-1

List of Tables

Table	Title	Page
3-1.	RS232 Pin Functions.....	3-4
7-1.	Phase Range and Resolution - Triggered Burst Mode	7-5
16-1.	Remote Command Summary	16-22
1-1.	Approved Fuse Types	1-1

List of Figures

Figure	Title	Page
4-1.	Single-Channel Simplified Block Diagram.....	4-5
4-2.	Clock Synthesis Mode.....	4-6
4-3.	Direct Digital Synthesis Mode	4-6
8-1.	Tone Waveform Types.....	8-3
16-1.	Single Instrument RS232 Connections	16-3
16-2.	RS232 Daisy-Chained Instruments	16-3
16-3.	RS232 Daisy-Chain Connector Wiring.....	16-4
16-4.	Status Model.....	16-9
1-1.	Mains Transformer Connections - Model 281	1-2
1-2.	Mains Transformer Connections - Models 282 and 284.....	1-2
6-1.	Block Diagram: Single Channel.....	6-1
6-2.	Inter-Channel Block Diagram	6-2
7-1.	Front Panel - Model 281.....	7-1
7-2.	Front Panel - Model 282.....	7-2
7-3.	Front Panel - Model 284.....	7-2
7-4.	Rear Panel - Model 281.....	7-3
7-5.	Rear Panel - Models 282 and 284	7-3

Chapter 1

Introduction and Specifications

Introduction.....	1-2
Overview	1-2
Features	1-2
Specifications.....	1-4
Waveforms	1-4
Standard Waveforms.....	1-4
Sine, Cosine, Haversine, Haver cosine	1-4
Square.....	1-4
Triangle	1-4
Ramps and Sin(x)/x.....	1-4
Pulse and Pulse Train.....	1-4
Arbitrary.....	1-5
Sequence	1-5
Output Filter.....	1-5
Operating Modes	1-5
Triggered Burst	1-5
Gated	1-6
Sweep.....	1-6
Tone Switching	1-6
Trigger Generator.....	1-7
Outputs	1-7
Main Output	1-7
Sync Out.....	1-7
Cursor/Marker Out.....	1-8
Inputs	1-8
Trig In	1-8
Modulation In.....	1-8
Sum In	1-8
Hold.....	1-8
Ref Clock In/Out.....	1-8
Inter-channel Operation.....	1-9
Inter-channel Modulation.....	1-9
Inter-channel Analog Summing	1-9
Inter-channel Phase Locking.....	1-9
Inter-channel Triggering	1-10
Interfaces	1-10
General	1-10

Introduction

Overview

This manual describes the features and operation of the Fluke models 281, 282 and 284 single-, two- and four-channel arbitrary waveform generators.

The physical differences between the two and four-channel generators are straightforward: the two-channel instrument has no set-up keys or output connections for channels three and four.

The single-channel instrument has essentially the same keys but they are arranged quite differently to suit the half-rack case. There are drawings of all three models at the end of this manual.

The set-up and operation of an individual channel in any of the instruments is identical and therefore no distinction is made between the different models when describing the functions associated with any single channel.

Those features associated with multi-channel operation (inter-channel summing, phase-locking, etc.) self-evidently apply only to the multi-channel instruments; the relevant chapters are mostly grouped together towards the end of the manual (but before Remote Operation) although some mention of multi-channel operation is made when appropriate in earlier sections. To avoid repetition specific reference is not always made to two- and four-channel instruments in the text; it is obvious when the description applies only to a multi-channel instrument.

Features

These synthesized programmable arbitrary waveform generators have the following features:

- 1, 2 or 4 independent 'arb' channels
- Sampling frequency up to 40 MHz
- Sine waves and square waves up to 16 MHz
- 12-bit vertical resolution
- 64K points horizontal resolution per channel
- 256K point non-volatile waveform memory
- Waveform linking, looping and sequencing
- Inter-channel triggering, summing, modulation and phase control
- GPIB and RS232 interfaces

A combination of direct digital synthesis and phase lock loop techniques provides high performance and extensive facilities in compact instruments. These instruments can generate a wide variety of waveforms between 0.1 mHz and 16 MHz with high resolution and accuracy.

You can define arbitrary waveforms with 12 bit vertical resolution and from 4 to 65,536 horizontal points. In addition a number of standard waveforms are available including sine, square, triangle, ramp and pulse.

You can replay arbitrary waveforms at a user specified waveform frequency or period, or you can define the sample rate in terms of period or frequency.

The instruments provide extensive waveform editing features between defined start and end points, including waveform insert, point edit, line draw, amplitude adjust and invert.

The supplied Windows™-based arbitrary waveform creation software gives access to more comprehensive features, allowing you to create waveforms from mathematical expressions, from combinations of other waveforms, freehand, or using a combination of all three techniques. Waveforms created in this way are downloaded via the RS232 or GPIB interface.

Up to 100 waveforms may be stored, each with a user-specified length and name. Waveforms may be strung together to form a sequence of up to 16 steps. Each waveform may have a user defined repeat count from 1 to 32,768.

All waveforms can be swept over their full frequency range at a rate variable between 30 milliseconds and 15 minutes. Sweeps can be linear or logarithmic, single or continuous. Single sweeps can be triggered from the front panel, the trigger input, or from the digital interfaces. A sweep marker is provided.

Amplitude modulation is available for all waveforms and is controlled from the previous channel or from an external generator via the **MODULATION** input socket.

Signal summing is available for all waveforms and is driven from the previous channel or from an external generator via the **SUM** input socket.

All waveforms are available as a triggered burst, whereby each active edge of the trigger signal will produce one burst of the carrier. The number of cycles in the burst can be set between 1 and 1,048,575.

The gated mode turns the output signal on when the gating signal is true and off when it is false.

Both triggered and gated modes can be operated from the previous or next channel, from the internal trigger generator (0.005 Hz to 100 kHz), from an external source (dc to 1 MHz) or by a key press or remote command.

Any number of channels can be phase locked with the phase angle under user control. You can use this feature to generate multi-phase waveforms or locked waveforms of different frequencies.

If you need more signals than one instrument provides you can use the signals from the **REF IN/OUT** and **SYNC OUT** sockets to phase lock two instruments.

The generator parameters are clearly displayed on a backlit LCD with four rows of 20 characters. Soft-keys and sub menus are used to guide you through even the most complex functions.

You can enter all parameters directly from the numeric keypad. Most parameters can also be incremented or decremented using the rotary control. This system combines quick and easy numeric data entry with quasi-analogue adjustment when required.

The generator has RS232 and GPIB interfaces as standard which can be used for remote control of all of the instrument functions or for the down-loading of arbitrary waveforms.

As well as operating in conventional RS232 mode the serial interface can also be used in addressable mode whereby you can link up to 32 instruments to a single PC serial port.

Specifications

Specifications apply at 18-28°C after 30 minutes warm-up, at maximum output into 50 Ω

Waveforms

Standard Waveforms

Sine, square, triangle, DC, positive ramp, negative ramp, sin(x)/x, pulse, pulse train, cosine, haversine and havercosine.

Sine, Cosine, Haversine, Havercosine

Range:	0.1 MHz to 16 MHz
Resolution:	0.1 MHz or 7 digits
Accuracy:	10 ppm for 1 year
Temperature stability:	Typically <1 ppm/°C.
Output level:	2.5 mV to 10 V p-p into 50 Ω
Harmonic distortion:	<0.1% THD to 100 kHz <-65 dBc to 20 kHz <-50 dBc to 300 kHz <-35 dBc to 10 MHz <-30 dBc to 16 MHz
Non-harmonic spurious:	<-65 dBc to 1 MHz, <-65 dBc + 6dB/octave 1 MHz to 16 MHz

Square

Range:	1 MHz to 16 MHz
Resolution:	1 MHz (4 digits)
Accuracy:	±1 digit of setting
Output level:	2.5 mV to 10 V p-p into 50 Ω
Rise and fall times:	<25 ns

Triangle

Range:	0.1 MHz to 100 kHz
Resolution:	0.1 MHz or 7 digits
Accuracy:	10 ppm for 1 year
Output level:	2.5 mV to 10 V p-p into 50 Ω
Linearity error:	<0.1 % to 30 kHz

Ramps and Sin(x)/x

Range:	0.1 MHz to 100 kHz
Resolution:	0.1 MHz (7 digits)
Accuracy:	10 ppm for 1 year
Output level:	2.5 mV to 10 V p-p into 50 Ω
Linearity error:	<0.1 % to 30 kHz

Pulse and Pulse Train

Output level:	2.5 mV to 10 V p-p into 50 Ω
Rise and fall times:	<25 ns
Period:	
range:	100 ns to 100 s
resolution:	4-digit
accuracy:	±1 digit of setting

Delay:
 range: -99.99 s to + 99.99 s
 resolution: 0.002 % of period or 25 ns, whichever is greater
 Width:
 range: 25 ns to 99.99 s
 resolution: 0.002 % of period or 25 ns, whichever is greater
 Note that the pulse width and absolute value of the delay may not exceed the pulse period at any time.

Pulse trains of up to 10 pulses may be specified, each pulse having independently defined width, delay and level. The baseline voltage is separately defined and the sequence repetition rate is set by the pulse train period.

Arbitrary

Up to 100 user defined waveforms may be stored in the 256K point non-volatile RAM. Waveforms can be defined by front panel editing controls or by downloading of waveform data via RS232 or GPIB.

Waveform memory size: 64K points per channel. Maximum waveform size is 64K points, minimum waveform size is 4 points
 Vertical resolution: 12 bits
 Sample clock range: 100 mHz to 40 MHz
 Resolution: 4 digits
 Accuracy: ± 1 digit of setting

Sequence

Up to 16 waveforms may be linked.
 Each waveform may have a loop count of up to 32,768.
 A sequence of waveforms can be looped up to 1,048,575 times or run continuously.

Output Filter

Selectable between 16 MHz elliptic, 10 MHz elliptic, 10 MHz Bessel, or none.

Operating Modes

Triggered Burst

Each active edge of the trigger signal produces one burst of the waveform.

Carrier waveforms: All standard and arbitrary
 Maximum carrier frequency: The smaller of 1 MHz or the maximum for the selected waveform.
 40 M samples/s for arb and sequence.
 Number of cycles: 1 to 1,048,575
 Trigger repetition rate: 0.005 Hz to 100 kHz internal
 DC to 1 MHz external.
 Trigger signal source: Internal from keyboard, previous channel, next channel or trigger generator.
 External from **TRIG IN** or remote interface.
 Trigger start/stop phase: $\pm 360^\circ$ settable with 0.1° resolution, subject to waveform frequency and type.

Gated

Waveform runs while the gate signal is true and stops while false.

Carrier waveforms:	All standard and arbitrary.
Maximum carrier frequency:	The smaller of 1 MHz or the maximum for the selected waveform. 40 M samples/s for arb and Sequence.
Trigger repetition rate:	0.005 Hz to 100 kHz internal DC to 1 MHz external.
Gate signal source:	Internal from keyboard, previous channel, next channel or trigger generator. External from TRIG IN or remote interface.
Gate start/stop phase:	$\pm 360^\circ$ settable with 0.1° resolution, subject to waveform frequency and type.

Sweep

Frequency sweep capability is provided for both standard and arbitrary waveforms. Arbitrary waveforms are expanded or condensed to exactly 4096 points and DDS techniques are used to perform the sweep.

Carrier waveforms:	All standard and arbitrary except pulse, pulse train and sequence.
Sweep mode:	Linear or logarithmic, triggered or continuous.
Sweep direction:	Up, down, up/down or down/up.
Sweep range:	From 1 mHz to 16 MHz in one range. Phase continuous. Independent setting of start and stop frequency.
Sweep time:	30 ms to 999 s (3 digit resolution).
Marker:	Variable during sweep.
Sweep trigger source:	The sweep may be free run, triggered manually from the keyboard, or triggered externally from the TRIG IN input or the remote interface.
Sweep hold:	Sweep can be held and restarted by the HOLD key.
Multi channel sweep:	Any number of channels may be swept simultaneously but the sweep parameters will be the same for all channels. Amplitude, offset and waveform can be set independently for each channel.

Tone Switching

Capability provided for both standard and arbitrary waveforms. Arbitrary waveforms are expanded or condensed to exactly 4096 points and DDS techniques are used to allow instantaneous frequency switching.

Carrier waveforms:	All waveforms except pulse, pulse train and sequence.
Frequency list:	Up to 16 frequencies from 1 mHz to 10 MHz.
Trigger repetition rate:	0.005 Hz to 100 kHz internal DC to 1 MHz external. Usable repetition rate and waveform frequency depend on the tone switching mode.
Source:	Internal from keyboard, previous channel, next channel or trigger generator. External from TRIG IN or remote interface.

Tone switching modes:	
gated:	The tone is output while the trigger signal is true, and stopped at the end of the current waveform cycle, while the trigger signal is false. The next tone is output when the trigger signal is true again.
triggered:	The tone is output when the trigger signal goes true. The next tone is output, at the end of the current waveform cycle, when the trigger signal goes true again.
FSK:	The tone is output when the trigger signal goes true. The next tone is output, immediately, when the trigger signal goes true again.

You can generate DTMF test signals by summing the outputs of two channels.

Trigger Generator

Internal source 0.005 Hz to 100 kHz square wave, adjustable in 10 μ s steps. 3 digit resolution. Available for external use from any **SYNC OUT** socket.

Outputs

Main Output *- one for each channel*

Output impedance:	50 Ω
Amplitude:	5 mV to 20 V p-p open circuit (2.5 mV to 10 V p-p into 50 Ω). Amplitude can be specified open circuit (hi Z) or into an assumed load of 50 Ω or 600 Ω in V p-p, V rms or dBm.
Amplitude accuracy:	2 % \pm 1 mV at 1 kHz into 50 Ω .
Amplitude flatness:	\pm 0.2 dB to 200 kHz; \pm 1 dB to 10 MHz; \pm 2.5 dB to 16 MHz.
DC offset range:	\pm 10 V (DC offset plus signal peak limited to \pm 10 V from 50 Ω)
DC offset accuracy:	Typically 3% \pm 10 mV, unattenuated.
Resolution:	3 digits for both amplitude and dc offset.

Sync Out *- one for each channel*

Multifunction output user definable or automatically selected to be any of the following:

Waveform sync: (all waveforms)	A square wave with 50% duty cycle at the main waveform frequency, or a pulse coincident with the first few points of an arbitrary waveform.
Position markers: (arbitrary only)	Any point(s) on the waveform may have associated marker bit(s) set high or low.
Burst done:	Produces a pulse coincident with the last cycle of a burst.
Sequence sync:	Produces a pulse coincident with the end of a waveform sequence.
Trigger:	Selects the current trigger signal. Useful for synchronizing burst or gated signals.
Sweep sync:	Outputs a pulse at the start of a sweep to synchronize an oscilloscope or recorder.
Phase lock out:	Used to phase lock two generators. Produces a positive edge at the 0 $^{\circ}$ phase point.

Output signal level: TTL/CMOS logic levels from typically 50 Ω

Cursor/Marker Out

Adjustable output pulse for use as a marker in sweep mode or as a cursor in arbitrary waveform editing mode. Can be used to modulate the Z-axis of an oscilloscope or be displayed on a second oscilloscope channel.

Output Signal Level: Adjustable from nominally 2 to 14 V, normal or inverted; adjustable width as a cursor.

Output Impedance: 600 Ω typical

Inputs

Trig In

Frequency range: DC to 1 MHz.

Signal range: Threshold nominally TTL level; max input ± 10 V

Minimum pulse width: 50 ns, for trigger and gate modes;
50 μ s for sweep mode.

Polarity: Selectable as high/rising edge or low/falling edge.

Input impedance: 10 k Ω

Modulation In

Frequency range: DC to 100 kHz.

Signal range: VCA: Approximately 1 V p-p for 100 % level change at maximum output.

SCM: Approximately ± 1 V pk for maximum output.

Input impedance: Typically 1 k Ω

Sum In

Frequency range: DC to 8 MHz

Signal range: Approximately 2 V p-p input for 20 V p-p output.

Input impedance: Typically 1 k Ω

Hold

Holds an arbitrary waveform at its current position. A TTL low level or switch closure causes the waveform to stop at the current position and wait until a TTL high level or switch opening which allows the waveform to continue. The front panel **MAN HOLD** key or a remote command may also be used to control the hold function. While held the front panel **MAN TRIG** key or remote command may be used to return the waveform to the start. The **HOLD** input may be enabled independently for each channel.

Input impedance: 10 k Ω

Ref Clock In/Out

Set to input: Input for an external 10MHz reference clock.
TTL/CMOS threshold level.

Set to output: Buffered version of the internal 10 MHz clock.
Output levels nominally 1 V and 4 V from 50 Ω

Set to phase lock: Used together with **SYNC OUT** on a master and **TRIG IN** on a slave to synchronize (phase lock) two separate generators.

Inter-channel Operation

Inter-channel Modulation

The waveform from any channel may be used to amplitude modulate (AM) or suppressed carrier modulate (SCM) the next channel. Alternatively any number of channels may be modulated (AM or SCM) with the signal at the **MODULATION** input socket.

Carrier frequency:	Entire range for selected waveform.
Carrier waveforms:	All standard and arbitrary waveforms.
Modulation types:	
AM:	Double sideband with carrier.
SCM:	Double sideband suppressed carrier.
Modulation source:	Internal from the previous channel. External from the modulation input socket. The external modulation signal may be applied to any number of channels simultaneously.
Frequency range:	DC to >100 kHz.
Internal AM:	
depth:	0 % to 105 %
resolution:	1 %
carrier suppression:	SCM: better than -40 dB.
External modulation signal range:	VCA: Approximately 1 V p-p for 100 % level change at maximum output. SCM: Approximately ± 1 V pk for maximum output.

Inter-channel Analog Summing

Waveform summing sums the waveform from any channel into the next channel.

Alternatively any number of channels may be summed with the signal at the **SUM IN** socket.

Carrier frequency:	Entire range for selected waveform.
Carrier waveforms:	All standard and arbitrary waveforms.
Sum source:	Internal from the previous channel. External from SUM IN socket.
Frequency range:	DC to >8 MHz.
External signal range:	Approximately 5 V p-p input for 20 V p-p output.

Inter-channel Phase Locking

Two or more channels may be phase locked together. Each locked channel may be assigned a phase angle relative to the other locked channels. Arbitrary waveforms and waveform sequences may be phase locked but certain constraints apply to waveform lengths and clock frequency ratios. With one channel assigned as the master and other channels as slaves a frequency change on the master will be repeated on each slave. This allows easy generation of multi-phase waveforms at the same frequency.

DDS waveforms are those with seven digits of frequency setting resolution, while non-DDS waveforms have four digits

Phase resolution:	
DDS waveforms:	0.1 °
non-DDS waveforms:	0.1 ° or 360 ° divided by the number of points, whichever is the greater
Phase error:	
all waveforms:	< ± 10 ns

The signals from the **REF IN/OUT** socket and the **SYNC OUT** socket can be used to phase lock two instruments where more than 4 channels are required.

Inter-channel Triggering

Any channel can be triggered by the previous or next channel.

The previous/next connections can be used to "daisy chain" a trigger signal from a "start" channel, through a number of channels in the chain to an "end" channel. Each channel receives the trigger out signal from the previous (or next) channel, and drives its selected trigger out to the next (or previous) channel. The "end" channel trigger out can be set up to drive the "start" channel, closing the loop.

In this way, complex and versatile inter-channel trigger schemes may be set up. Each channel can have its trigger out and its output waveform set up independently. Trigger out may be selected from waveform end, position markers, sequence sync or burst done.

Using the scheme above it is possible to create a sequence of up to 64 waveform segments, each channel producing up to 16 segments and all channels being summed to produce the complete waveform at the output of channel 4.

Interfaces

Full remote control facilities are available through the RS232 or GPIB interfaces.

RS232	Variable Baud rate, 9600 Baud maximum. 9-pin D-connector.
IEEE-488	Conforms with IEEE488.1 and IEEE488.2

General

Display:	20 character x 4 row alphanumeric LCD.		
Data Entry:	Keyboard selection of mode, waveform etc. Value entry direct by numeric keys or by rotary control.		
Stored Settings:	Up to 9 complete instrument set-ups may be stored and recalled from battery-backed memory. Up to 100 arbitrary waveforms can also be stored independent of the instrument settings.		
Operating Range:	+5 °C to +40 °C, 20-80 % RH		
Storage Range:	-20 °C to +60 °C.		
Environmental:	Indoor use at altitudes up to 2000 m, Pollution Degree 2.		
Options:	19 inch rack mounting kit.		
Safety:	Complies with EN61010-1.		
EMC:	Complies with EN61326.		
Power:	100 V, 110 V-120 V or 220 V-240 V AC ± 10 %, 50/60 Hz, adjustable internally; Installation category II		
	<u>Model 281</u>	<u>Model 282</u>	<u>Model 284</u>
Size:	40 VA maximum height 3U (130 mm) width 212 mm depth 335mm	75 VA maximum height 3U (130 mm) width 350 mm depth 335 mm	100 VA maximum height 3U (130 mm) width 350 mm depth 335 mm
Weight:	4.1kg (9lb)	7.2 kg (16 lb)	7.2 kg (16 lb)

Chapter 2

Installation

Mains Operating Voltage.....	2-2
Fuse.....	2-2
Mains Lead	2-2
Mounting.....	2-2

Mains Operating Voltage

Check that the instrument operating voltage marked on the rear panel is correct for the local supply. If it is necessary to change the operating voltage, follow the procedure described in appendix A.

Fuse

Ensure that the correct mains fuse is fitted for the set operating voltage. The correct mains fuse types are listed in Appendix A.

Mains Lead



To avoid the possibility of electric shock, this instrument must be earthed. Any interruption of the mains earth conductor inside or outside the instrument will make the instrument dangerous. Intentional interruption is prohibited. The protective action must not be negated by the use of an extension cord without a protective conductor.

When a three core mains lead with bare ends is provided it should be connected as follows:-

Brown	Mains Live
Blue	Mains Neutral
Green / Yellow	Mains Earth

Mounting

This instrument is suitable both for bench use and rack mounting. It is delivered with feet for bench mounting. The front feet include a tilt mechanism for optimal panel angle.

A rack kit for mounting in a 19" rack is available from the manufacturers.

Chapter 3 Connections

- Introduction..... 3-2
- Front Panel Connections..... 3-2
 - MAIN OUT 3-2
 - SYNC OUT 3-2
 - TRIG IN 3-3
 - SUM IN 3-3
 - MODULATION IN..... 3-3
- Rear Panel Connections..... 3-3
 - REF CLOCK IN/OUT..... 3-3
 - HOLD IN..... 3-4
 - CURSOR/MARKER OUT..... 3-4
 - RS232 3-4
 - GPIB (IEEE-488) 3-5

Introduction

This chapter describes the front- and rear-panel connections and their functions.

Front Panel Connections

MAIN OUT (1 per channel)

MAIN OUT is the 50 Ω output from the channel's main generator. It provides up to 20 V p-p into an open circuit or 10 V p-p into a matched 50 Ω load. It can tolerate a short circuit for 60 seconds.



Caution

To avoid risk of damage to the instrument, do not apply external voltages to these outputs.

SYNC OUT (1 per channel)

SYNC OUT provides a TTL/CMOS level output which may be set to any of the following signals from the **SYNC OUT** screen.

<code>waveform sync</code>	A sync marker phase-coincident with the MAIN OUT waveform of that channel. For standard waveforms, (sine, cosine, haversine/cosine, square, triangle, $\sin(x)/x$ and ramp), the sync marker is a square wave with a 1:1 duty cycle, the rising edge at the 0° phase point and the falling edge at the 180° phase point. For arbitrary waveforms the sync marker is a positive pulse coincident with the first few points (addresses) of the waveform.
<code>position marker</code>	When <code>pos'n marker</code> is selected, the instrument generates a pulse marker pattern for arbitrary waveforms. The pulse pattern is programmable from the <code>edit waveform</code> menu on the <code>MODIFY</code> screen. When the MAIN OUT waveform is a standard waveform <code>pos'n marker</code> automatically changes to <code>phase zero</code> which is a narrow (1 clock) pulse output at the start of each standard waveform cycle.
<code>Burst done</code>	Provides a signal during gate or trigger modes which is low while the waveform is active at the main output, high at all other times.
<code>Sequence sync</code>	Provides a signal which is low during the last cycle of the last waveform in a sequence, high at all other times.
<code>Trigger</code>	Provides a positive going version of the trigger signal. Internal, external, manual and remote all produce a trigger sync.
<code>Sweep sync</code>	Goes high at the start of the sweep, goes low at the end of the sweep.
<code>Phase lock</code>	Produces a positive edge coincident with the start of the current waveform. This is used for phase locking instruments.

SYNC OUT logic levels are nominally 0 V and +5V from typically 50 Ω.
SYNC OUT will withstand a short circuit.



Caution

To avoid risk of damage to the instrument, do not apply external voltages to this output.

TRIG IN

TRIG IN is the external input for trigger, gate, sweep and sequence operations. It is also the input used to synchronize the generator as a slave to another generator which is the master.



Caution

To avoid risk of damage to the instrument, do not apply external voltages exceeding ±10 V to this input.

SUM IN

SUM IN is the input socket for external signal summing. The channel(s) with which this signal is to be summed are selected on the **SUM** screen.



Caution

To avoid risk of damage to the instrument, do not apply external voltages exceeding ±10 V to this input.

MODULATION IN

MODULATION IN is the input socket for external modulation. Any number of channels may be amplitude or suppressed-carrier modulated with this signal; the target channels are selected on the **MODULATION** screen.



Caution

To avoid risk of damage to the instrument, do not apply external voltages exceeding ±10 V to this input.

Rear Panel Connections

REF CLOCK IN/OUT

The function of the **REF CLOCK IN/OUT** socket is set from the **ref clock i/o** menu on the **UTILITY** screen, as described under "System Operations from the Utility Menu".

- input This is the default setting. The socket becomes an input for an external 10 MHz reference clock. The system automatically switches over from the internal clock when the external reference is applied.
- output The internal 10 MHz clock is made available at the socket.
- phase lock When two or more generators are synchronized the slaves are set to phase lock slave and the master is set to phase lock master.

As an output the logic levels are nominally 1 V and 4 V from typically 50 Ω .
REF CLOCK IN/OUT will withstand a short-circuit.

As an input the threshold is TTL/CMOS compatible.



Caution

To avoid risk of damage to the instrument, do not apply external voltages exceeding ± 10 V to this socket.

HOLD IN

HOLD IN controls the waveform hold function. The input impedance is nominally 10 k Ω .



Caution

To avoid risk of damage to the instrument, do not apply external voltages exceeding ± 10 V to this input.

CURSOR/MARKER OUT

The **CURSOR/MARKER OUT** socket provides an output pulse for use as a marker in sweep mode or as a cursor in arbitrary waveform editing mode. It can be used to modulate the Z-axis of an oscilloscope or can be displayed on a second oscilloscope channel. The output impedance is nominally 600 Ω and the signal level is adjustable from 2 to 14 V (nominal) from the `cursor/marker` menu on the `UTILITY` screen, as described in chapter 14, *System Operations from the Utility Menu*.



Caution

To avoid risk of damage to the instrument, do not apply external voltages to this output.

RS232

The **RS232** interface is on a 9-pin D-connector and is compatible with addressable RS232 use. The pin connections are shown below:

Table 3-1. RS232 Pin Functions

Pin number	Signal name	Description
1	-	No internal connection
2	TXD	Transmitted data from instrument
3	RXD	Received data to instrument
4	-	No internal connection
5	GND	Signal ground
6	-	No internal connection
7	RXD2	Secondary received data
8	TXD2	Secondary transmitted data
9	GND	Signal ground

Pin 2, 3 and 5 may be used as a conventional RS232 interface with XON/XOFF handshaking. Pins 7, 8 and 9 are used when the instrument is operated in addressable RS232 mode. Signal grounds are connected to the instrument ground. The RS232 address is set from the `remote` menu on the `UTILITY` screen, as described in chapter 14, *System Operations from the Utility Menu*.

GPIB (IEEE-488)

The **GPIB** interface is not isolated; the GPIB signal grounds are connected to the instrument ground.

The implemented subsets are:

SH1, AH1, T6, TE0, L4, LE0, SR1, RL1, PP1, DC1, DT1, C0, E2.

The GPIB address is set from the `remote` menu on the `UTILITY` screen, as described chapter 14, *System Operations from the Utility Menu*.

Chapter 4

Initial Operation

Introduction.....	4-2
Initial Operation	4-2
Switching On	4-2
Display Contrast	4-2
Keyboard	4-2
Principles of Editing	4-3
Principles of Operation	4-5
Clock Synthesis Mode.....	4-5
DDS Mode.....	4-6

Introduction

This section is a general introduction to the organization and principles of the instrument and is intended to be read before using the generator for the first time. Detailed operation is covered in later sections starting with chapter 5, *Standard Waveform Operation*.

In this *Users Manual* front panel keys and sockets are shown in capitals, e.g. **CREATE**, **SYNC OUT**; all soft-key labels, entry fields and messages displayed on the LCD are shown in the Courier type-font, e.g. STANDARD WAVEFORMS, sine.

Initial Operation

Switching On

The power switch is located at the bottom left of the front panel.

At power-up the generator displays the installed software revision whilst loading its waveform RAM. If an error is encountered the message SYSTEM RAM ERROR, CHECK BATTERY will be displayed. If this happens, refer to appendix B, *Warnings and Error Messages*.

Loading takes a few seconds, after which the status screen is displayed, showing the generator parameters set to their default values, with the **MAIN OUT** outputs set to off.

The power-up settings may be preset to those at power-down or to any of the stored settings; chapter 14, *System Operations from the Utility Menu* explains how to do this.

You can recall the status screen at any time with the **STATUS** key; a second press returns the display to the previous screen.

On multi-channel instruments the status shown is that of the channel selected by the **SETUP** keys; this is the channel currently enabled for editing and is always the last channel selected, whether power has been switched off or not. You can change the basic generator parameters for the selected channel as described in chapter 5, and you can switch the output on with the **MAIN OUT** key; the **ON** lamp will light to show that output is on.

Display Contrast

All parameter settings are displayed on the 20 character x 4 row backlit liquid crystal display (LCD). The contrast may vary a little with changes of ambient temperature or viewing angle but can be optimized for a particular environment by using the front panel contrast control. Insert a small screwdriver or trimmer tool through the adjustment aperture marked **LCD** and rotate the control for optimum contrast.

Keyboard

Pressing the front panel keys displays screens which list parameters or choices relative to the key pressed. Selections are then made using the display soft-keys. Numeric values are changed using either the numeric keys or the rotary control, as described later in this chapter under *Principles of Editing*.

The keys are grouped as follows:

- **WAVE SELECT** keys call screens from which all standard or already defined arbitrary waveforms can be selected.
- **WAVE EDIT** keys call screens from which arbitrary waveforms can be created and modified.

- **FREQ**uency, **AMPL**itude, **OFFSET** and **MODE** keys display screens which permit their respective parameters to be edited either from the numeric keypad or using the rotary control/cursor keys.
- Numeric keys permit direct entry of a value for the parameter currently selected. Values are accepted in three formats: integer (**20**), floating point (**20.0**) and exponential (**2 EXP 1**).

For example, to set a new frequency of 50 kHz, press **FREQ** followed by **50000 ENTER** or **5 EXP 4 ENTER**.

ENTER confirms the numeric entry and changes the generator setting to the new value.

- **CE** (clear entry) undoes a numeric entry digit by digit. **ESCAPE** returns a setting being edited to its last value.
- **MODULATION**, **SUM**, **TRIG IN** and **SYNC OUT** call screens from which the parameters of those input/outputs can be set, including whether the port is on or off. **SWEEP** similarly calls a screen from which all the sweep parameters can be set.
- Each channel has a key which directly switches the **MAIN OUT** of that channel on and off.
- **MAN TRIG** is used for manual triggering (when **TRIG IN** is appropriately set) and for synchronizing two or more generators when suitably connected together. **MAN HOLD** is used to manually pause arbitrary waveform output and sweep; the output is held at the level it was at when **MAN HOLD** was pressed.
- **UTILITY** gives access to menus for a variety of functions such as remote control interface set-up, power-up parameters, error message settings and store/recall set-ups to/from non-volatile memory; the **STORE** and **RECALL** keys can also be used to directly access the non-volatile stores.
- The **INTER CH**annel and **COPY CH**annel keys (multi-channel instruments only) directly call screens from which channel-to-channel phase locking and set-up copying can be controlled.
- The **SETUP** keys (multi-channel instruments only) select the channel to be edited; the lamp lights beside the channel currently enabled for editing.
- Eight soft-keys around the display are used to directly set or select parameters from the currently displayed menu; their operation is described in more detail in the next section.
- The **STATUS** key always returns the display to the default start-up screen which gives an overview of the generator's status. Pressing **STATUS** again returns the display to the previous screen.

Further explanations will be found in the detailed descriptions of the generator's operation.

Principles of Editing

Each screen called up by pressing a front panel key shows parameter value(s) and/or a list of choices. Parameter values can be edited by using the rotary control in combination with the left and right arrowed cursor keys, or by direct numeric keyboard entry; choices are made using the soft-key associated with the screen item to be selected. The examples which follow assume factory default settings.

Note

*On multi-channel instruments the channel to be edited must first be selected by pressing the appropriate **SETUP** key; the lamp lights beside the **SETUP** key of the channel currently enabled for editing.*

A diamond beside a screen item indicates that it is selectable; hollow diamonds (◊) identify deselected items and filled diamonds (◆) denote selected items. For example, press **MODE** to get the screen shown below:

```

MODE :
◆continuous
◊gated          setup...◊
◊triggered     setup...◊

```

The filled diamond indicates that the selected mode is `continuous`. Gated or triggered modes are selected by pressing the associated soft-key which will make the diamond beside that item filled and the diamond beside `continuous` hollow. This screen also illustrates how an ellipsis (three dots following the screen text) indicates that a further screen follows when that item is selected. In the case of the `MODE` screen illustrated, pressing the `setup...` soft-key on the bottom line brings up the `TRIGGER SETUP` menu; note that selecting this item does not change the `continuous / gated / triggered` selection.

Some screen items are marked with a double-headed arrow (↕) when selected to indicate that the item's setting can be changed by further presses of the soft-key, by pressing either cursor key or by using the rotary control. For example, pressing **FILTER** brings up the screen shown below.

```

FILTER SETUP
↕mode: auto
◊type: 10MHz elliptic

```

Repeated presses of the `mode` soft-key will toggle the mode between its two possible settings of `auto` and `manual`. Similarly, when `type` is selected, repeated presses of the `type` soft-key (or cursor keys or use of the rotary control) will step the selection through all possible settings of the filter type.

In addition to their use in editing items identified by a double-headed arrow as described above, the cursor keys and the rotary control operate in two other modes.

In screens with lists of items that can be selected (i.e. items marked with a diamond) the cursor keys and rotary control are used to scroll all items through the display if the list has more than three items; look, for example at the `STD` (standard waveform) and `UTILITY` screens.

In screens where a parameter with a numeric value is displayed the cursor keys move the edit cursor (a flashing underline) through the numeric field and the rotary control will increment or decrement the value; the step size is determined by the position of the edit cursor within the numeric field.

Thus for STANDARD FREQUENCY set to 1.000000 MHz rotating the control will change the frequency in 1 kHz steps. The display will auto-range up or down as the frequency is changed, provided that autoranging permits the increment size to be maintained; this will in turn determine the lowest or highest setting that can be achieved by turning the control. In the example above, the lowest frequency that can be set by rotating the control is 1 kHz, shown on the display as 1.000000 kHz.

This is the limit because to show a lower frequency the display would need to autorange below 1 kHz to xxx.xxx Hz, in which the most significant digit represents 100Hz, i.e. the 1 kHz increment would be lost. If, however, the starting frequency had been set to 1.000000 MHz, i.e. a 100 Hz increment, the display would have autoranged at 1 kHz to 000.0000 Hz and could then be decremented further to 000.0000 Hz without losing the 100 Hz increment.

Turning the control quickly will step numeric values in multiple increments.

Principles of Operation

The instrument operates in one of two different modes depending on the waveform selected. Direct digital synthesis (DDS) mode is used for sine, cosine, haversine, triangle, sin(x)/x and ramp waveforms. Clock synthesis mode is used for square, pulse, pulse train, arbitrary and sequence.

In both modes the waveform data is stored in RAM. As the RAM address is incremented the values are output sequentially to a digital-to-analogue converter (DAC) which reconstructs the waveform as a series of voltages steps which are subsequently filtered before being passed to the **MAIN OUT** connector.

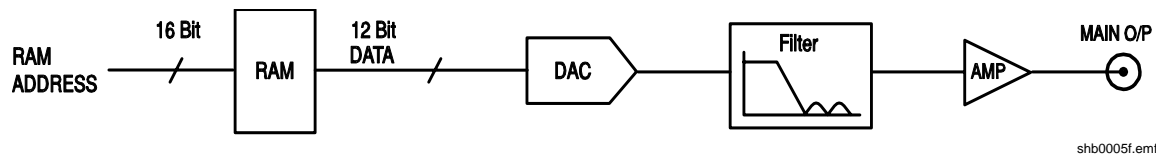

Figure 4-1. Single-Channel Simplified Block Diagram

The main differences between DDS and clock synthesis modes are the way in which the addresses are generated for the RAM and the length of the waveform data.

Clock Synthesis Mode

In clock synthesis mode the addresses are always sequential (an increment of one) and the clock rate is adjusted by the user in the range 40 MHz to 0.1 Hz. The frequency of the waveform is the clock frequency divided by the waveform length, thus allowing short waveforms to be played out at higher repetition rates than long waveforms.

For example the maximum frequency of a 4 point waveform is $40,000,000 \div 4$ or 10 MHz, but a 1000 point waveform has a maximum frequency of $40,000,000 \div 1000$ or 40 kHz.

Arbitrary waveforms have a user defined length of 4 to 65,536 points. Square waves use a fixed length of 2 points and pulse and pulse train have their length defined by the user selected period value.

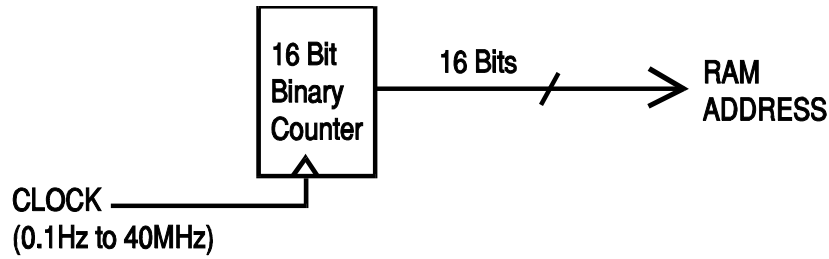

Figure 4-2. Clock Synthesis Mode

shb0006f.emf

DDS Mode

In DDS mode all waveforms are stored in RAM as 4096 points. The frequency of the output waveform is determined by the rate at which the RAM addresses are changed. The address changes are generated as follows:

The RAM contains the amplitude values of all the individual points of one cycle (360 °) of the waveform; each sequential address change corresponds to a phase increment of the waveform of 360/4096 degrees. Instead of using a counter to generate sequential RAM addresses, a phase accumulator is used to increment the phase.

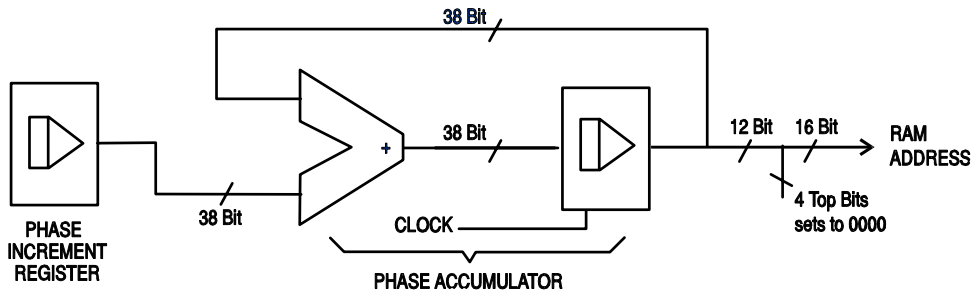

Figure 4-3. Direct Digital Synthesis Mode

shb0007f.emf

On each clock cycle the phase increment, which has been loaded into the phase increment register by the CPU, is added to the current result in the phase accumulator; the 12 most significant bits of the phase accumulator drive the lower 12 RAM address lines, the upper 4 RAM address lines being held low. The output waveform frequency is now determined by the size of the phase increment at each clock. If each increment is the same size then the output frequency is constant; if it changes, the output frequency changes as in sweep mode.

The generator uses a 38 bit accumulator and a clock frequency which is $2^{38} \times 10^{-4}$ (approximately 27.4878 MHz); this yields a frequency resolution of 0.1 mHz.

Only the 12 most significant bits of the phase accumulator are used to address the RAM. At a waveform frequency equal to the clock frequency divided by 4096, approximately 6.7 kHz, the natural frequency, the RAM address increments at every clock. At all frequencies below this (i.e. at smaller phase increments) one or more addresses are output for more than one clock period because the phase increment is not big enough to step the address at every clock. Similarly at frequencies above the natural frequency the larger phase increment causes some addresses to be skipped, giving the effect of the stored waveform being sampled; different points will be sampled on successive cycles of the waveform.

Chapter 5

Standard Waveform Operation

Introduction.....	5-2
Standard Waveform Operation	5-2
Setting Generator Parameters	5-2
Waveform Selection	5-2
Frequency	5-2
Amplitude	5-3
DC Offset	5-4
Warning and Error Messages.....	5-5
SYNC Output.....	5-6

Introduction

This section deals with the use of the instrument as a standard function generator, i.e. generating sine, square, triangle, dc, ramp, haversine, cosine, havercosine and $\sin(x)/x$ waveforms. All but the square wave are generated by DDS which gives 7-digit frequency precision; the square wave is generated by clock synthesis which results in only 4-digit frequency resolution. Refer to *Principles of Operation* in the previous chapter for an explanation of the differences.

Standard Waveform Operation

The STANDARD WAVEFORMS screen also includes arbitrary and sequence for simplicity of switching between these and standard waveforms; they do, however, have their own screens (accessed by pressing **ARB** and **SEQUENCE** respectively) and are described in detail in their appropriate sections. Pulse and pulse-train are also accessed from the standard waveforms screen but are sufficiently different to justify their own section in this manual.

Most of the following descriptions of amplitude and offset control, as well as of mode, sweep, etc., in following sections, apply to arbitrary and sequence as well as standard waveforms; for clarity, any differences of operation with arbitrary, sequence, pulse and pulse-train are described only in the appropriate sections.

Setting Generator Parameters

Waveform Selection

Pressing the **STD** key gives the STANDARD WAVEFORMS screen which lists all the waveforms available:

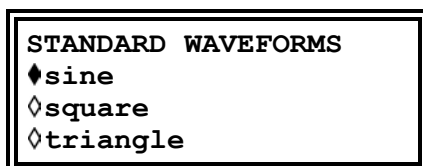

The rotary control or cursor keys can be used to scroll the full list back and forward through the display. The currently selected waveform (sine, with the factory defaults setting) is indicated by the filled diamond; the selection is changed by pressing the soft-key beside the required waveform.

Frequency

Pressing the **FREQ** key gives the STANDARD FREQUENCY screen:

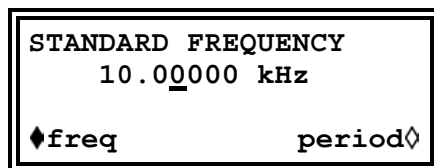

With `freq` selected as shown above, the frequency can be entered directly from the keyboard in integer, floating point or exponential format. For example, 12.34 kHz can be entered as **12340**, **12340.00**, or **1.234 exp 4**, etc. However, the display will

always show the entry in the most appropriate engineering units, in this case
12.34000 kHz.

With `period` selected instead of `freq` the frequency can be set in terms of a period, for example 123.4 μ s can be entered as **-0001234** or **123.4 exp -6**; again the display will always show the entry in the most appropriate engineering units. Note that the precision of a period entry is restricted to 6 digits; 7 digits are displayed but the least significant is always zero. The hardware is programmed in terms of frequency, so that when you make a period entry the synthesized frequency is the nearest equivalent value that the frequency resolution and a 6-digit conversion calculation gives. If the frequency is displayed after a period entry the value may differ from the expected value because of these considerations. Further, once the setting has been displayed as a frequency, converting back again to display period will give an exact 6-digit equivalent of the 7-digit frequency, but this may differ from the period value originally entered.

Square waves, generated by clock synthesis, provides 4-digit resolution for both frequency and period entry but the hardware is still programmed in terms of frequency and the same differences may occur in switching the display from period to frequency and back to period.

Turning the rotary control will increment or decrement the numeric value in steps determined by the position of the edit cursor (flashing underline); the cursor is moved with the left- and right-arrowed cursor keys.

Note that the upper frequency limits vary for the different waveform types; refer to the Specifications section for details.

Frequency setting for arbitrary, sequence pulse and pulse-train is explained in the relevant sections.

Amplitude

Pressing the **AMPL** key gives the `AMPLITUDE` screen:

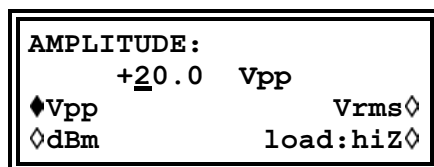

The waveform amplitude can be set in terms of peak-to-peak volts (`Vpp`), rms volts (`Vrms`) or dBm (referenced to a 50 Ω or 600 Ω load). For `Vpp` and `Vrms` the level can be set assuming that the output is open-circuit (`load:hiZ`) or terminated (`load:50 Ω` or `load:600 Ω`); when dBm is selected termination is always assumed and the `load:hiZ` setting is automatically changed to `load:50 Ω` . Note that the actual generator output impedance is always 50 Ω ; the displayed amplitude values for 600 Ω termination take this into account.

With the appropriate form of the amplitude selected (indicated by the filled diamond) the amplitude can be entered directly from the keyboard in integer, floating point or exponential format. For example 250 mV can be entered as **-250 exp -3** or **250**, etc. The display will always show the entry in the most appropriate engineering units, in this case 250 mV.

Turning the rotary control will increment or decrement the numeric value in steps determined by the position of the edit cursor (flashing underline); the cursor is moved with the left- and right-arrowed cursor keys.

Alternate presses of the \pm key will invert the signal at the **MAIN OUT** socket; if the **DC OFFSET** is non-zero the signal is inverted about the same offset. The exception to this occurs when the amplitude is specified in dBm. Since low level signals are specified in dBm (0 dBm = 1 mW into 50 Ω = 0.224 mV rms) the - sign is interpreted as part of a new amplitude entry and not as a command to invert the signal.

Note that for dc, sin(x)/x, pulse train, arbitrary and sequence, the amplitude can only be displayed and entered in the V_{pp} form; further limitations on pulse-train, arbitrary and sequence amplitude are discussed in the appropriate sections.

DC Offset

Pressing the **OFFSET** key gives the DC OFFSET screen:

```

DC OFFSET:
program +0.00 mVdc
(actual +0.00 mVdc)
load:hiZ◊

```

The offset can be entered directly from the keyboard in integer, floating point or exponential format, for example 100 mV can be entered as **-1** or **100 exp -3**, etc. The display will always show the entry in the most appropriate engineering units, in this case 100mV. During a new offset entry the \pm key can be used at any time to invert the offset; alternate presses toggle the sign between + and -.

Turning the rotary control will increment or decrement the numeric value in steps determined by the position of the edit cursor (flashing underline); the cursor is moved with the left- and right-arrowed cursor keys. Because the dc offset can have negative values, the rotary control can take the value below zero; although the display may autorange to a higher resolution if a step takes the value close to zero, the increment size is maintained correctly as the offset is stepped negative. For example, if the display shows

```
program = +205· mVdc
```

with the cursor in the most significant digit, the rotary control will decrement the offset in 100 mV steps as follows:

```

program = +205· mVdc
program = +105· mVdc
program = +5·00 mVdc
program = -95·0 mVdc
program = -195· mVdc

```

The actual dc offset at the **MAIN OUT** socket is attenuated by the fixed-step output attenuator when this is in use. Since it is not obvious when the signal is being attenuated the actual offset is shown in brackets as a non-editable field below the programmed value.

For example, if the amplitude is set to 2.5 V p-p the output is not attenuated by the fixed attenuator and the actual dc offset (in brackets) is the same as that set.

The DC OFFSET display shows:

```

DC OFFSET:
program +1.50 Vdc
(actual +1.50 Vdc)
load:hiZ◊
    
```

If the amplitude is now reduced to, say, 250 mV pp, this introduces the attenuator and the actual dc offset changes by the appropriate factor:

```

DC OFFSET:
program +1.50 Vdc
(actual +151 mVdc)
load:hiZ◊
    
```

The above display shows that the set DC offset is +1.50V but the actual offset is +151mV.

Note

The actual offset value also takes into account the true attenuation provided by the fixed attenuator, using the values determined during the calibration procedure. In the example displayed the output signal is 250 mV p-p exactly and takes account of the small error in the fixed attenuator; the offset is 151 mV (to three significant figures) and takes account of the effect of the calibrated attenuation error on the set offset of 1.50 V.

Whenever the set dc offset is modified by a subsequent change in output level the display shows a warning message. Similarly, settings which would result in peak offset+signal levels outside the range ± 10 V (and therefore clipping) generate a similar warning message. There is additional information on these messages in the *Warnings and Error Messages* section below.

The output attenuation is controlled intelligently to minimize the difference between the programmed and actual offset when the combination of programmed amplitude and offset allows this. Thus when the offset is set to 150 mV, for example, the amplitude can be reduced to nominally 50 mV pp before the fixed attenuator causes the actual offset to be different from the programmed value.

Warning and Error Messages

Two classes of message are displayed on the screen when an illegal combination of parameters is attempted.

WARNING messages are shown when the entered setting causes some change which the user might not necessarily expect, as in the following two examples:

1. Changing the amplitude from, for example, 2.5 V p-p to 25 mV p-p brings in the step attenuator; if a non-zero offset has been set then this will also be attenuated. The message DC OFFSET CHANGED BY AMPLITUDE will be shown temporarily on the screen but the setting will be accepted; in this case the actual attenuated offset will be shown in brackets below the set value.
2. With the output level set to 10 V p-p, increasing the dc offset beyond ± 5 V will cause the message OFFSET + SUM + LEVEL MAY CAUSE CLIPPING. The offset change will be accepted (producing a clipped waveform) and the user may then

choose to change the output level or the offset to produce a signal which is not clipped. The word (clip?) will show in the display beside `AMPLITUDE` or `DC OFFSET` while the clipped condition exists.

ERROR messages are shown when an illegal setting is attempted, most generally a number outside the range of values permitted. In this case the entry is rejected and the parameter setting is left unchanged, as in the following three examples:

1. Entering a frequency of 1 MHz for a triangle waveform. The error message:
Frequency out of range for the selected waveform is shown.
2. Entering an amplitude of 25 V pp. The error message:
Maximum output level exceeded is shown.
3. Entering a DC offset of 20 V. The error message:
Maximum DC offset exceeded is shown.

The messages remain on the display for approximately two seconds. The last two messages can be viewed again by pressing the `last error...` soft-key on the **UTILITY** screen.

Each message has a number and the full list appears in appendix B.

The default set-up is for all warning and error messages to be displayed and for a beep to sound with each message. This set-up can be changed on the `error...` menu on the **UTILITY** screen. The error menu is shown below:

```

◇error beep: ON
◇error message: ON
◆warn beep: ON
◇warn message: ON

```

Each feature can be turned on and off with alternate presses of the associated soft-key; the factory default is for all features to be on. If the setting is changed and is required for future use it should be saved by changing the `POWER ON SETTING` on the `power on...` menu of the **UTILITY** screen to restore last setup.

SYNC Output

SYNC OUT is a multifunction CMOS/TTL level output that can be automatically or manually set to be any of the following:

- | | |
|------------------|--|
| waveform sync: | A square wave with 50 % duty cycle at the main waveform frequency, or a pulse coincident with the first few points of an arbitrary waveform. Can be selected for all waveforms. |
| position marker: | Can be selected for arbitrary waveforms only. Any point(s) on the main waveform may have associated marker bit(s) set high or low. When the MAIN OUT waveform is a standard waveform position marker is not available and this choice on the list automatically becomes phase zero; if selected, phase zero produces a narrow (1 clock) pulse at the start of each standard waveform cycle. |

burst done:	Produces a pulse coincident with the last cycle of the burst.
sequence sync:	Produces a pulse coincident with the end of a waveform sequence.
trigger:	Selects the current trigger signal (internal, external, adjacent channel or manual). Useful for synchronizing burst or gated signals.
sweep sync:	Outputs the sweep trigger signal.
phase lock:	Used to lock two or more generators. Produces a positive edge at the 0° phase point.

The setting up of the signals themselves is discussed in the relevant sections later in this manual, e.g. trigger is covered in chapter 7, *Triggered Burst and Gate* and position markers in chapter 9, *Arbitrary Waveform Generation*.

Pressing the **SYNC OUT** key calls the SYNC OUT set-up screen:

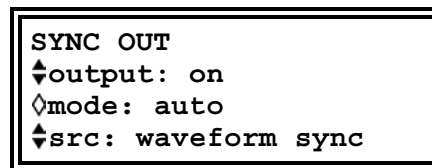

SYNC OUT is turned on and off by alternate presses of the output soft-key.

The selection of the signal to be output from the **SYNC OUT** socket is made using the src (source) soft-key; repeated presses of src cycle the selection through all the choices (waveform sync, position marker, etc.) listed above. Alternatively, with the src selected (double-headed arrow) the rotary control or cursor keys can be used to step backwards and forwards through the choices.

The source selection of the **SYNC OUT** waveform can be made automatic (auto) or user-defined (manual) with alternate presses of the mode soft-key. In automatic mode the **SYNC OUT** waveform most appropriate for the current main waveform is selected.

For example, waveform sync is automatically selected for all continuous standard and arbitrary waveforms, but trigger is selected in trigger or gated waveform modes. The automatic selection will be mentioned in each of the appropriate main waveform mode sections and a full table is given in appendix C.

The automatic selection can still be changed manually by the src soft-key even when auto mode has been selected but the selection will immediately revert to the automatic choice as soon as any relevant parameter (e.g. main waveform frequency or amplitude) is adjusted. You must select manual with the mode soft-key for a source other than the automatic choice to remain set. The auto selection will generally set the most frequently used signal, for example waveform sync for all continuous main waveforms, but you will need to use manual for any special requirements, such as position markers on arbitrary waveforms.

Chapter 6

Sweep Operation

Introduction.....	6-2
Principles of Sweep Operation	6-2
Connections for Sweep Operation.....	6-2
Setting Sweep Parameters.....	6-3
Sweep Range	6-3
Sweep Time	6-4
Sweep Type	6-4
Manual Sweep	6-5
Sweep Spacing.....	6-6
Sweep Marker.....	6-6
Sweep Hold	6-6

Introduction

Principles of Sweep Operation

All standard and arbitrary waveforms can be swept with the exception of pulse, pulse-train and sequence. During sweep all waveforms are generated in DDS mode because this offers the significant advantage of phase-continuous sweeps over a very wide frequency range (up to $10^{10}:1$). However it must be remembered that the frequency is actually stepped, not swept linearly, and thought needs to be given as to what the instrument is actually doing when using extreme combinations of sweep range and time.

For DDS operation during sweep all waveforms must be 4096 points in length; this is the natural length for standard waveforms but all arbitrary waveforms are expanded or compressed in software to 4096 points when sweep is turned on. The expansion or compression leaves the original data unaffected.

Sweep mode is turned on and off by the `on` or `off` soft-key on the `SWEEP SETUP` screen (accessed by pressing the **SWEEP** front panel key), or by the `sweep` soft-key on the `MODE` screen. In multi-channel instruments two or more channels can be swept at once but one set of sweep parameters applies to all the swept channels.

When sweep is switched on the software creates a table of 2048 frequencies between, and including, the specified start and stop values. For sweep times of 1.03 s and above the sweep will step through all 2048 frequency values. Below 1.03 s, however, the frequency sweep will contain fewer steps because of the minimum 0.5 ms dwell at each step; at the shortest sweep time (30 ms) the sweep will contain only 60 steps.

Because any frequency used in sweep mode must be one of the tabled values, the centre frequency displayed (see *Sweep Range*) may not be the exact mid-point and markers (see *Sweep Marker*) may not be exactly at the programmed frequencies. The frequency resolution of the steps will be at its most coarse with wide sweeps at the fastest sweep rate.

Connections for Sweep Operation

Sweeps are generally used with an oscilloscope or hard-copy device to investigate the frequency response of a device. The **MAIN OUT** is connected to the device input and the device output is connected to an oscilloscope or, for slow sweeps, a recorder.

An oscilloscope or recorder can be triggered by connecting its trigger input to the generator's **SYNC OUT** socket. This defaults to `sweep sync` when sweep is turned on, going high at the start of sweep and low at the end of the sweep. The low period is sufficiently long to allow an oscilloscope to retrace.

To show a marker on the display instrument the rear panel **CURSOR/MARKER OUT** socket should be connected to a second channel. It can also be used in the case of an oscilloscope to modulate the Z-axis. See the *Sweep Marker* section below for information on setting the marker frequency. The cursor/marker polarity and level is set up on the `cursor/marker...` menu of the `UTILITY` screen, as described in chapter 14, *System Operations from the Utility Menu*.

For triggered sweeps you must provide a trigger signal, either electrically at the front panel **TRIG IN** socket, by a remote command or by manually pressing the **MAN TRIG** key. The **TRIG IN** function automatically defaults to external when you select triggered sweep. A sweep is initiated on the rising edge of the trigger signal.

The generator does not provide a ramp output for use with X-Y displays or recorders.

Setting Sweep Parameters

Pressing the **SWEEP** key (or the sweep setup... soft-key on the **MODE** screen) displays the **SWEEP SETUP** screen:

```
SWEEP SETUP:      off↕
↕range...        type...↕
↕time...         spacing...↕
↕manual...       marker...↕
```

Menus for setting up the range, time (sweep rate), type (continuous, triggered, etc.) spacing (linear or logarithmic) and marker position are all accessed from this screen using the appropriate soft-key. In addition the control screen for manual sweep (i.e. sweeping using the rotary control or cursor keys) is selected from this screen and sweep mode itself is turned on and off with alternate presses of the **on/off** soft-key.

Sweep can also be turned on by the **sweep** soft-key on the **MODE** screen. In multi-channel instruments two or more channels can be swept at once using the same sweep parameters. The channels to be swept are set on or off by selecting them in turn with the appropriate **SETUP** key and then using the **on/off** soft-key of the **SWEEP SETUP** screen.

On all the following menus, pressing the **done** soft-key returns the display to this **SWEEP SETUP** screen.

Sweep Range

Pressing the **range...** soft-key calls the **SWEEP RANGE** screen:

```
SWEEP RANGE:
↕start: 100.0      kHz
↕stop: 10.00      MHz
↕centr/span       done↕
```

The maximum sweep range for all waveforms is 1 mHz to 16 MHz, including triangle, ramp and square wave (which have different limits in unswept operation).

You can define the sweep range in terms either of the start and stop frequencies or of the centre frequency and span. **start** and **stop** soft-keys permit the two end points of the sweep to be set directly from the keyboard or by using the rotary control; the start frequency must be lower than the stop frequency (but see *Sweep Type* below for selecting the sweep direction).

Pressing the **centr/span** soft-key changes the screen to permit entry in terms of centre frequency and sweep span about that frequency; pressing the **start/stop** soft-key on that screen returns the display to the start and stop frequency form of entry.

Note that when the sweep is displayed in terms of centre frequency and span the span will always be the exact difference between start and stop frequencies but the centre frequency shown will be that of the frequency step nearest the true centre frequency, as described in the section above, *Principles of Sweep Operation*.

Sweep Time

Pressing the `time...` soft-key calls the `SWEEP TIME` screen:

```

SWEEP TIME:
  0.05 sec
  (steps=100)
                                done◇
  
```

The sweep time can be set from 0.03 to 999 s with 3-digit resolution by direct keyboard entry or by using the rotary control. As explained above, sweeps lasting less than 1.03 seconds will contain less than the maximum 2048 steps because of the minimum 0.5 ms dwell at each step. For this reason the number of steps in the sweep is displayed as a non-editable field below the sweep time.

Sweep Type

Pressing the `type` soft-key calls the `SWEEP TYPE` screen:

```

SWEEP TYPE:
◇continuous
◇direction: up
◇sync: on                                done◇
  
```

This screen is used to set the sweep mode (continuous; triggered; triggered, hold and reset; manual) and sweep direction.

Successive presses of the `direction` soft-key select one of the following sweep directions:

- `up` start frequency to stop frequency.
- `down` stop frequency to start frequency.
- `up/down` start frequency to stop frequency and back to start frequency.
- `down/up` stop frequency to start frequency and back to stop frequency.

The total sweep time is always that set on the `SWEEP TIME` screen, i.e. for `up/down` and `down/up` operation the sweep time in each direction is half the total. Similarly the total number of steps is the same for all choices, i.e. there will be half the number of steps in each direction for `up/down` and `down/up` operation. In the sweep mode descriptions which follow the direction is assumed to be `up` but all modes can be used with all sweep directions.

In `continuous` mode the generator sweeps continuously between the start and stop frequencies, triggered repetitively by an internal trigger generator whose frequency is determined by the sweep time setting. At the stop frequency the generator resets to the start frequency after a delay (nominally long enough for an oscilloscope to retrace), and begins a new sweep.

If `sync` is set to `on` (the default) the generator steps from the stop frequency to zero frequency and then starts the next sweep from the first point of the waveform, synchronized to the internally generated trigger signal.

This is useful because it forces the sweep always to start from the same point in the waveform. You should be aware that in this case the waveform discontinuity may be undesirable in some circumstances, for example in filter evaluation.

With `sync` is set to `off` the frequency steps directly and phase continuity is maintained from the stop frequency to the start frequency. Note, however, that the sweep is not synchronized to the software-generated trigger signal.

In `triggered` mode the generator holds the output at the start frequency until it recognizes a trigger, at which the frequency sweeps to the stop frequency, resets, and awaits the next trigger. If `sync` is set to `on` the frequency resets to zero frequency (i.e. no waveform) and starts a new sweep at the first point of the waveform when the next trigger is recognized. If `sync` is set to `off` the waveform resets to the start frequency and continues at that frequency until the next trigger initiates a new sweep.

In `trig'd, hold/reset` mode the generator holds the output at the start frequency until it recognizes a trigger; at which point the frequency sweeps to the stop frequency and holds. At the next trigger the output is reset to the start frequency where it is held until the next sweep is initiated by a further trigger. If `sync` is set to `off` the output operates exactly as described above; if `sync` is set to `on` the frequency goes to zero at the start and begins each new sweep at the first point of the waveform.

For both `triggered` and `trig'd, hold/reset` modes the **TRIG IN** input is automatically set to external. The trigger source can be the rising edge of an external signal applied to **TRIG IN**, a press of the **MAN TRIG** key on the front panel, or a remote command.

In `manual` mode the whole sweep process is controlled from the `MANUAL SWEEP` screen.

Manual Sweep

Pressing the `manual...` soft-key on the `SWEEP SETUP` screen calls the `MANUAL SWEEP FREQ` screen:

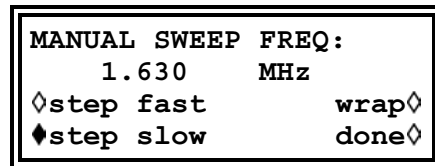

Before manual control can be used, you must select `manual` on the `SWEEP TYPE` screen. If `manual` has not been set, the message `mode is not manual` will be displayed instead of the frequency.

In `manual` mode the frequency can be stepped through the sweep range, defined on the `SWEEP RANGE` screen, by using the rotary control or cursor keys. Every point of the frequency table is stepped through if `step slow` is selected; if `step fast` is set then the frequency changes in multiple step increments. You can not select `step fast` when the number of steps in the table is small.

If `wrap` is set the sweep wraps-round from `start frequency` to `stop frequency` and vice-versa; if no `wrap` is set the sweep finishes at either the `start` or `stop frequency` depending on the direction of the rotary control or cursor keys.

Sweep Spacing

Pressing the `spacing...` soft-key on the `SWEEP SETUP` screen calls the `SWEEP SPACING` screen:

```

SWEEP SPACING:
♦logarithmic
◇linear
done◇

```

With `linear` selected the sweep changes the frequency at a linear rate; with `logarithmic` selected the sweep spends an equal time in each frequency decade.

Sweep Marker

Pressing the `marker...` soft-key on the `SWEEP SETUP` screen calls the `SWEEP MARKER FREQ` screen:

```

SWEEP MARKER FREQ:
program: 5.000 MHz
actual: 4.977 MHz
done◇

```

A new marker frequency can be programmed directly from the keyboard or by using the rotary control and cursor keys. Note that the marker frequency can only be one of the values in the sweep frequency table; any value in the sweep range can be entered but the actual value will be the nearest frequency in the table. When sweep is turned on, the actual marker frequency is shown in the non-editable field below the programmed frequency. For the default sweep setting of 100 kHz to 10 MHz in 50 ms (which is completed in 400 steps), the actual frequency of a 5 MHz marker is 4.977 MHz.

The marker duration is for the number of 0.5 ms intervals that the frequency remains at the marker value; for fast and/or wide sweeps this will often be the 0.5 ms minimum but for slow and/or narrow spans the marker may last many 0.5 ms intervals. To avoid anomalous conditions the marker will not be exactly placed at the start and stop frequencies even though it can be programmed to be so. The marker polarity and level is set up on the `cursor/marker...` menu of the `UTILITY` screen. For full details refer chapter 14, *System Operations from the Utility Menu*.

You can change the marker frequency can be changed while the sweep is on but since the table of frequency values is rebuilt with each change this can be a slow process, especially if the rotary control is used. You can achieve the same result more quickly by switching the sweep off, changing the marker, then switching the sweep back on.

Sweep Hold

The sweep can be held or restarted at any time at or from its current frequency by alternate presses of the **MAN HOLD** key or by a remote command. As with all other sweep controls, pressing **MAN HOLD** will halt the sweep on all channels for which sweep has been set on.

Chapter 7

Triggered Burst and Gate

Introduction.....	7-2
Internal Trigger Generator.....	7-2
External Trigger Input	7-3
Adjacent Channel Trigger Output	7-3
Triggered Burst.....	7-3
Trigger Source.....	7-4
Trigger Edge.....	7-4
Burst Count.....	7-4
Start Phase	7-5
Manual Initialization of Inter-channel Triggering.....	7-5
Gated Mode.....	7-6
Gate Source	7-6
Gate Polarity.....	7-6
Start Phase	7-6
Sync Out in Triggered Burst and Gated Mode	7-7

Introduction

Triggered burst and gated modes are selected from the `MODE` screen, called by the **MODE** key, as alternatives to the default continuous mode.

```

MODE:
◆continuous
◇gated          setup...◇
◇triggered     setup...◇

```

In triggered burst mode a defined number of cycles are generated following each trigger event. This mode is edge triggered.

In gated mode the generator runs whenever the gating signal is true. This mode is level sensitive.

Triggered burst mode can be controlled by either the internal trigger generator, an external trigger input, the internally-generated trigger out signal from an adjacent channel on a multi-channel instrument, by the front panel **MAN TRIG** key or by remote control.

Gated mode can be controlled by the internal trigger generator or by external trigger input.

In both modes the start phase, i.e. the starting point on the waveform cycle, can be specified.

Internal Trigger Generator

The period of the internal trigger generator is set with the `period` soft-key on the `TRIGGER IN` set-up screen called by the **TRIG IN** key:

```

TRIGGER IN:      force◇
◇source: internal
◇slope: positive
◆period: 2.00ms

```

The internal trigger generator divides down a crystal oscillator to produce a 1:1 square wave with a period from 0.01 ms (100 kHz) to 200 s (0.005 Hz). Generator period entries that cannot be exactly accommodated are accepted and rounded up to the nearest available value, e.g. 0.109ms is rounded to 0.11ms.

When triggered burst or gated modes are selected the **SYNC OUT** source automatically defaults to `trigger` which is the output of the internal trigger generator when internal triggering or gating is specified.

In triggered burst mode the selected edge of each cycle of the trigger generator is used to initiate a burst; the interval between bursts is therefore 0.01 ms to 200 s as set by the generator period.

In gated mode the output of the main generator is gated on while the internal trigger generator output is true; the duration of the gate is therefore 0.005 ms to 100 s, in step with trigger generator periods of 0.01 ms to 200 s.

External Trigger Input

External trigger or gate signals are applied to the front panel **TRIG IN** socket which has a TTL level (+1.5 V) threshold. In triggered burst mode the input is edge sensitive; the selected edge of each external trigger initiates the specified burst. In gated mode the input is level sensitive; the output of the main generator is on whilst the gate signal is true.

The minimum pulse width that can be used with **TRIG IN** in triggered burst and gated mode is 50 ns and the maximum repetition rate is 1 MHz. The maximum signal level that can be applied without damage is ± 10 V.

When triggered burst or gated modes are selected the **SYNC OUT** source automatically defaults to `trigger` which is always a positive-edged version of the external trigger or gate signal when external triggering or gating is specified.

Adjacent Channel Trigger Output

On multi-channel instruments the trigger out signal of an adjacent channel can be used as the control signal for a triggered burst. The channel numbering ‘wraps round’ such that channel 1 follows channel 4.

The source of the trigger out signal is selected by the `source` soft-key on the **TRIGGER OUT** screen called by the **TRIG OUT** key.

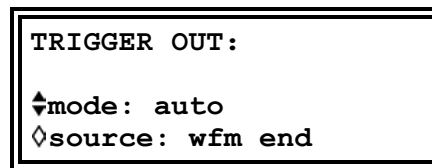

The `source` choices are as follows:

- `wfm end`: Waveform end; a positive-going pulse coincident with the end of a waveform cycle (and the start of the next).
- `pos'n marker`: Position marker; arbitrary waveforms only. Any point(s) on the main waveform may have marker bit(s) set high or low. No output if selected for a standard waveform.
- `seq sync`: Sequence sync; a positive-going pulse coincident with the end of a waveform sequence.
- `burst done`: A positive-going pulse coincident with the end of the last cycle of a burst.

The default choice is `wfm end` except when the channel is running a sequence in which case it becomes `seq sync`. To set the trigger out to anything other than its default it is necessary to change the mode from `auto` to `manual` using the `mode` soft-key.

Trigger out is an internal signal but, as with the other trigger sources, a positive-edged version is available at the triggered channel's **SYNC OUT** with its default source of `trigger` selected.

Triggered Burst

Triggered burst mode is turned on with the `triggered` soft-key on the **MODE** screen. The `setup...` soft-key on this screen accesses the **TRIGGER/GATE SETUP**

screen on which the burst count and start phase are set. The other trigger parameters are set on the **TRIGGER IN** set-up screen called by pressing the **TRIG IN** key.

```

TRIGGER IN:      force◊
◊source: internal
◊slope: positive
◆period: 2.00ms

```

Trigger Source

The trigger source can be selected with the `source` soft-key on the **TRIGGER IN** set-up screen to be `internal`, `external`, `manual` or (in the case of multi-channel instruments) either of the adjacent channels.

With `internal` selected the internal trigger generator is used to initiate a burst; this generator is set up as described in the previous section.

With `external` selected the specified edge of the signal at **TRIG IN** is used to initiate a burst.

With `chan x` selected (multi-channel instruments only) the trigger out signal from adjacent channel `x` is used to initiate a burst; the source of the trigger out signal on that channel `x` is set up as described in the previous section.

With `manual` selected as the source the only ways to initiate a burst are by pressing the **MAN TRIG** key or sending a remote command. In multi-channel instruments, pressing **MAN TRIG** will trigger all those channels for which `manual` has been selected as the source.

Trigger Edge

The `slope` soft-key is used to select the edge (`positive` or `negative`) of the external trigger signal used to initiate a burst. The default setting of `positive` should be used for triggering by the internal trigger generator or an adjacent channel's trigger out.

Note that the `trigger` signal from **SYNC OUT**, used for synchronizing the display of a triggered burst on an oscilloscope for example, is always positive-going at the start of the burst.

Burst Count

The number of complete cycles in each burst following the trigger is set from the **TRIGGER/GATE SETUP** screen, called by selecting `setup...` on the **MODE** screen:

```

TRIGGER/GATE SETUP:
◆burst cnt: 0000001
◊phase: +000.0°
(actual +000.0°)

```

The required count can be set by pressing the `burst cnt` soft-key followed by direct entries from the keyboard, or by using the rotary control. The maximum number of waveform cycles that can be counted is 1,048,575 ($2^{20}-1$).

Start Phase

The start phase, i.e. the point on the waveform cycle at which the burst starts, can be selected by pressing the `phase` soft-key followed by direct entries from the keyboard or by using the rotary control. Since the waveform cycle is always completed at the end of the burst the start phase is also the stop phase.

The phase can be set with a precision of 0.1° but the actual resolution is limited with some waveforms and at certain waveform frequencies as detailed below. To indicate when this is the case the actual phase is shown in brackets as a non-editable field below the programmed value.

To achieve start phase precision all waveforms are run in clock synthesis mode, i.e. as if they were arbitrary waveforms, when triggered burst is specified. This limits frequency resolution to 4 digits for all waveforms although the waveforms normally generated by DDS are still entered with 7-digit precision. Sine, cosine, haversine (etc.) waveforms are created as if they were arbitrary waveforms with the first point of the waveform exactly at the start phase. Each time the phase or frequency is changed the waveform is recalculated, and this can cause a slight lag if the parameters are changed quickly using the rotary control.

The phase resolution of true arbitrary waveforms is limited by the waveform length since the finest resolution is 1 clock cycle; thus waveforms with a length greater than 3600 points will have a resolution of 0.1° , but below this number of points the maximum resolution becomes 360° divided by the number of points.

Square waves, pulse, pulse trains and sequences have no start phase adjustment. Their phase is always fixed at 0° .

The start phase capabilities in triggered burst mode are summarized below:

Table 7-1. Phase Range and Resolution - Triggered Burst Mode

Waveform	Maximum Waveform Frequency	Phase Control Range and Resolution
Sine, cosine, haversine, havercosine	1 MHz	$\pm 360^\circ, 0.1^\circ$
Square	1 MHz	0° only
Triangle, Ramp, $\sin(x)/x$	100 kHz	$\pm 360^\circ, 0.1^\circ$
Pulse, Pulse Train	10 MHz	0° only
Arbitrary	40 Msamples/s clock	$\pm 360^\circ, 360^\circ$ divided by length or 0.1°
Sequence	40 Msamples/s clock	0° only

Manual Initialization of Inter-channel Triggering

If a multi-channel instrument is set up such that all channels are triggered by an adjacent one it is possible to have a stable condition where all channels are waiting for a trigger and the sequence of triggered bursts never starts. To overcome this problem any channel can be triggered manually and independently using the `force` soft-key on that

channel's TRIGGER IN screen. Select the channel to start the sequence with the appropriate **SETUP** key, select the TRIGGER IN screen with the **TRIG IN** key and press the `force` soft-key.

Gated Mode

Gated mode is turned on with the `gated` soft-key on the MODE screen. The `setup...` soft-key on this screen accesses the TRIGGER/GATE SETUP screen on which the start phase is set. The other parameters associated with gated mode are set on the TRIGGER IN set-up screen called by pressing the **TRIG IN** key.

```

TRIGGER IN:      force◊
◊source: internal
◊slope: positive
◆period: 2.00ms
  
```

Gate Source

The gate signal source can be selected with the `source` soft-key on the TRIGGER IN set-up screen to be `internal`, `external`, or (in the case of a multi-channel instrument) an adjacent channel.

With `internal` selected the internal trigger generator is used to gate the waveform; the duration of the gate is half the generator period. Refer to the section on the Internal Trigger Generator above for more information.

With `external` selected the gate duration is from the point (nominally +1.5 V) on the specified edge of the signal at the **TRIG IN** socket until the same level on the opposite edge.

With `chan x` selected the trigger out signal from the adjacent channel x is used to gate the waveform; the source of the trigger out signal on that channel x is set up as described in the previous section.

Gate Polarity

If `slope` on the TRIGGER IN set-up screen is set to `positive` the gate will open at the threshold on the rising edge and close on the threshold of the falling edge of an external gating signal. In other words the gate signal is true when the **TRIG IN** signal is high. If the `slope` is set `negative` the gate signal is true when the **TRIG IN** signal is low. The default setting of `positive` should be used for gating with the internal trigger generator or an adjacent channel's trigger out.

Start Phase

Press `setup...` on the MODE screen to access the TRIGGER/GATE SETUP screen on which the start phase can be set.

```

TRIGGER/GATE SETUP:
◆burst cnt: 000001
◊phase:   +000.0°
(actual  +000.0°)
  
```

The start phase, i.e. the point on the waveform cycle at which the gated waveform starts, can be selected by pressing the `phase` soft-key followed by direct entries from the keyboard or by using the rotary control. Since the waveform cycle is always completed at the end of the gated period the start phase is also the stop phase.

The phase can be set with a precision of 0.1° but the actual resolution is limited with some waveforms and at certain waveform frequencies as detailed below. To indicate when this is the case the actual phase is shown in brackets as a non-editable field below the programmed value.

To achieve start phase precision all waveforms are run in clock synthesis mode, i.e. as if they were arbitrary waveforms, when gated mode is specified. This limits frequency resolution to 4 digits for all waveforms although the waveforms normally generated by DDS are still entered with 7-digit precision. Sine, cosine, haversine (etc.) waveforms are created as if they were arbitrary waveforms with the first point of the waveform exactly at the start phase. Each time the phase or frequency is changed the waveform is recalculated, and this can cause a slight lag if the parameters are changed quickly using the rotary control.

The phase resolution of true arbitrary waveforms is limited by the waveform length since the maximum resolution is 1 clock; thus waveforms with a length greater than 3600 points will have a resolution of 0.1° , but below this number of points the maximum resolution becomes 360° divided by the number of points.

Square waves, pulse, pulse trains and sequences have no start phase adjustment. Their phase is always fixed at 0° .

Refer to the table in the *Triggered Burst* section above for a summary of start phase capabilities.

Sync Out in Triggered Burst and Gated Mode

When triggered burst or gated modes are selected the **SYNC OUT** source automatically defaults to `trigger`; this is a positive-edged signal synchronized to the actual trigger used whether internal (from the internal trigger generator or an adjacent channel) or external of either polarity.

Alternatively, **SYNC OUT** can be set to `burst done` on the `SYNC OUT` set-up screen; this provides a **SYNC OUT** signal which is low while the waveform is running and high at all other times.

Chapter 8

Tone Mode

Introduction..... 8-2
Tone Frequency 8-2
Tone Type..... 8-2
Tone Switching Source..... 8-3
DTMF Testing with a Multi-Channel Generator 8-4

Introduction

In Tone mode the output is stepped through a user-defined list of up to 16 frequencies under the control of the signal set by the `source` soft-key on the `TRIGGER IN` set-up screen. This signal can be the internal trigger generator, an external trigger input, the front panel **MAN TRIG** key or a remote command. On multi-channel instruments the control signal can also be the trigger out from an adjacent channel.

All standard and arbitrary waveforms can be used in tone mode with the exception of pulse, pulse-train and sequence. During tone mode all waveforms are generated in DDS mode for fast phase-continuous switching between frequencies. For DDS operation all waveforms must be 4096 points in length; this is the natural length for standard waveforms but all arbitrary waveforms are expanded or condensed in software to 4096 points when the tone list is built. This does not affect the original data.

Because DDS mode is used the frequency range for all waveforms is 1 mHz to 10 MHz in tone mode, including triangle, ramp and square wave, which have different limits in continuous operation.

Tone Frequency

Press the `tone setup...` soft-key on the `MODE` screen, called by pressing the **MODE** key. The `TONE` set-up screen will be displayed:

```
TONE          type: trig
◇2.000000 kHz #2
◆3.000000 kHz   del
◇end of list #4
```

Each frequency in the list can be changed by pressing the appropriate soft-key and entering the new value from the keyboard. The selected frequency can be deleted from the list by pressing the `del` (delete) soft-key. Additional frequencies can be added to the end of the list by selecting `end of list` with the appropriate soft-key and entering the new frequency from the keyboard.

The whole list can be scrolled back and forward through the display using the rotary control.

Tone Type

The `type` soft-key on the `TONE` set-up screen permits three types of tone switching to be specified.

With `type` set to `trig` the frequency changes after each occurrence of the signal edge specified in the `source` and `slope` fields on the `TRIGGER IN` screen, but only after completing the last cycle of the current frequency.

With `type` set to `gate` the frequency changes when the signal specified in the `source` field goes to the level specified in the `slope` field on the `TRIGGER IN` screen and continues until the level changes again, at which point the current cycle is completed. The output is then gated off until the next occurrence of the gating signal, at which point the next frequency in the list is gated on.

Thus the difference between triggered and gated tone changes is that in triggered mode the signal changes phase continuously from one frequency to the next at the waveform zero-crossing point immediately after the trigger signal, whereas in gated mode there can be an off (no signal) period between successive frequencies while the gate signal is not true.

With `type` set to `fsk` the frequency changes instantaneously (and phase-continuously) at each occurrence of the signal edge specified in the `source` and `slope` fields on the `TRIGGER IN` screen, without completing the current waveform cycle; this is true FSK (frequency shift keying) tone switching.

The following diagrams demonstrate the differences between trigger, gate and FSK tone switching for a list of two frequencies switched by a square wave (positive slope specified on the `TRIGGER IN` set-up).

The maximum recommended tone frequencies and trigger/gate switching frequencies for the three modes are as follows:

- GATE: Maximum tone frequency 50 kHz;
maximum switching frequency < lowest tone frequency.
- TRIGGER: Maximum tone frequency 50 kHz;
maximum switching frequency 1 MHz.
- FSK: Maximum tone frequency 1 MHz;
maximum switching frequency 1 MHz.

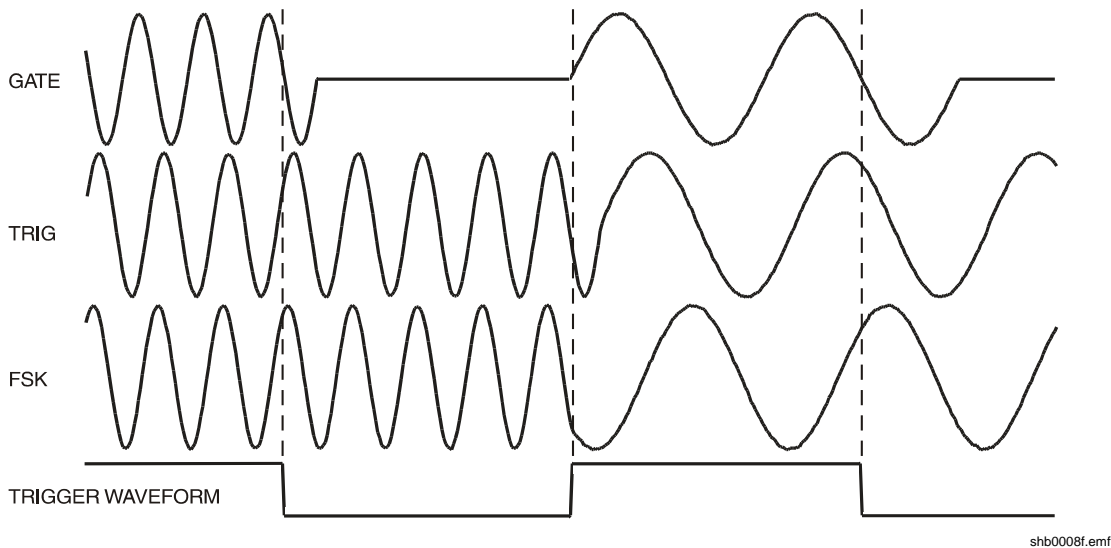

Figure 8-1. Tone Waveform Types

shb0008f.emf

Tone Switching Source

The signal which controls the frequency switching is that set by the `source` soft-key on the `TRIGGER IN` set-up screen. The `slope` field on the same screen sets the active polarity of that signal; when set to `positive` the rising edge of the trigger signal is active or the high level of the gating signal is true. The reverse is true for a `negative` setting. The signal selections available on the `source` soft-key are the internal trigger generator, an external trigger input, the front panel **MAN TRIG** key, a remote command and, for multi-channel instruments, the trigger output from an adjacent channel. A full explanation for each of these can be found in chapter 7, *Triggered Burst and Gate*.

DTMF Testing with a Multi-Channel Generator

An important use of tone mode is DTMF (Dual Tone Multiple Frequency) testing in which two channels are set up with equal length lists of different frequencies, triggered from a common signal. The outputs are summed together using the internal sum facility (see chapter 12, *Sum*). DTMF testing generally uses sine waves in the frequency range 600 Hz to 1.6 kHz.

It is also possible to set up DTMF testing using two single channel instruments triggered by a common external signal and summed using the external **SUM** capability.

Chapter 9

Arbitrary Waveform Generation

Introduction.....	9-2
Arb Waveform Terms.....	9-2
Arb Waveform Creation and Modification – General Principles	9-2
Selecting and Outputting Arbitrary Waveforms	9-3
Creating New Waveforms.....	9-4
Create Blank Waveform.....	9-4
Create Waveform Copy.....	9-5
Modifying Arbitrary Waveforms.....	9-6
Waveform Edit Cursor	9-6
Resize Waveform	9-6
Rename Waveform.....	9-7
Waveform Info	9-7
Delete Waveform.....	9-8
Edit Waveform	9-8
Point Edit.....	9-9
Line Edit.....	9-9
Wave Insert.....	9-9
Block Copy.....	9-10
Waveform Amplitude.....	9-11
Waveform Offset.....	9-11
Wave Invert	9-12
Position Markers.....	9-12
Arbitrary Waveform Sequence	9-13
Sequence Set-up	9-14
Frequency and Amplitude Control with Arbitrary Waveforms	9-15
Frequency.....	9-15
Amplitude.....	9-16
Sync Out Settings with Arbitrary Waveforms	9-16
Waveform Hold in Arbitrary Mode.....	9-16
Output Filter Setting	9-17

Introduction

Arbitrary (arb) waveforms are generated by sequentially addressing the RAM containing the waveform data with the arbitrary clock. The frequency of the arb waveform is determined both by the arb clock and the total number of data points in the cycle.

In this instrument an arb waveform can have up to 65,536 horizontal points. The vertical range is -2048 to +2047, corresponding to a maximum peak-peak output of 20 V. Up to 100 waveforms can be stored in the 256 kByte non-volatile RAM and each waveform may be given a name; the exact number that can be stored depends on the number of points in each waveform.

Arb waveforms can be created using basic front panel editing capabilities (particularly useful for modifying existing standard or arb waveforms) or by using waveform design software that enables the user to create waveforms from mathematical expressions, from combinations of other waveforms, or freehand. The appendix includes information about the software tools available.

Arb Waveform Terms

The following terms are used in describing arb waveforms:

Horizontal size.	The number of horizontal points is the time component of the waveform. The minimum size is 4 points and the maximum is 65,536 points.
Waveform address.	Each horizontal point on an arb waveform has a unique address. Addresses always start at 0000, thus the end address is always one less than the horizontal size.
Arb frequency	The arb frequency is the clock rate of the data RAM address counters and has a range of 0.1 Hz to 40 MHz on these instruments.
Waveform frequency.	The waveform frequency depends on both the arb frequency and the horizontal size; for example a 1000 point waveform clocked at an arb frequency of 40 MHz has a waveform frequency of $40 \times 10^6 / 1000 = 40$ kHz.
Data Value.	Each horizontal point in the waveform has an amplitude value in the range -2048 to +2047.
Arb waveform amplitude.	When playing arb waveforms the maximum output amplitude will depend on both the range of data values and the output amplitude setting. A waveform that contains data values ranging from -2048 to +2047 will produce a maximum output which is 100% of the programmed peak-to-peak amplitude; if the maximum range of the data values is only -1024 to +1023, for example, the maximum output will only be 50% of the programmed level.

Arb Waveform Creation and Modification – General Principles

Creating arb waveforms with the instrument alone consists of two main steps:

1. Creating a new blank waveform, or a copy of an existing one, and giving it a size and a name

2. Modifying that waveform using the various editing capabilities to get exactly the waveform required.

These steps are fully described in the *Creating New Waveforms* and *Modifying Arbitrary Waveforms* sections which follow.

Waveform creation using waveform design software also consists of two steps:

1. Creating the waveform using the software on a PC.
2. Downloading the waveform to the generator via the RS232 or GPIB interface.

Certain constraints apply to the overall operation of the generator during creation and modification of an arb waveform on the instrument; these ensure proper management of the arb waveforms and avoid contentions, particularly in multi-channel instruments. The constraints are mentioned in the individual sections which follow but are summarized here.

1. On multi-channel instruments all the channels must be running in continuous mode to allow arb creation or modification. Summing and modulation of channels is allowed.
2. Arb waveforms are created and mostly edited in the non-volatile backup memory; up to 100 waveforms can be stored subject to the memory limitation of 256 kBytes. Any of these waveforms can be called into a channel's memory by selecting them to run as an arb or as part of an arb sequence, up to the channel's limit of 65,536 points. During editing, changes are made to the waveform in non-volatile memory and are then copied to all the channels where that waveform is used. The exceptions to this are amplitude, offset and block copy changes which are initially made only to the waveform copy of the channel currently selected; the changes are copied to the non-volatile back-up memory (and then to any other channels using that waveform) when the parameter edit is confirmed with the `save` soft-key.
3. A waveform cannot be deleted from a channel's memory if it is running on that channel.
4. Waveforms must be deleted from the channel's memory before they can be deleted from the back-up memory.
5. If an arb waveform sequence is running no waveforms can be deleted from that channel, whether they are used in the sequence or not.
6. A waveform used by a non-active sequence can be deleted but the sequence will not subsequently run properly and should be modified to exclude the deleted waveform.

You will be reminded of the above constraints by a warning or error message in the display if you attempt an illegal operation.

Selecting and Outputting Arbitrary Waveforms

At switch-on, assuming factory default settings, any arbitrary waveforms already created will only be stored in the non-volatile back-up memory. To run an arbitrary waveform it is necessary to select it from the list in back-up memory.

Press the **ARB** key to see the list, on the `ARBS` screen, of all arbitrary waveforms held in back-up memory.

ARBS:	backup	mem◇
◇wv00	01024	
◇wv01	03782	
◇wv02	00500	

The rotary control or cursor keys can be used to scroll the full list backwards and forwards through the display. With the appropriate channel selected using its **SETUP** key press the soft-key beside the required waveform to load it into that channel's memory. Many waveforms can be loaded into and held in the channel's memory in this way, up to the 64k point limit. The last one selected will be the one currently output on that channel.

Once an arb waveform has been loaded into a channel it can also be selected to run from the STANDARD WAVEFORMS screen, accessed by pressing the **STD** key, by pressing the **arb** soft-key. If more than one arb waveform is held in the channel's memory the last one selected will be the one that is output. The complete list of waveforms held in a channel's memory can be viewed by pressing the top right soft-key on the ARBS screen; this causes the channel memory to be displayed instead of the backup memory, for example:

ARBS:	chan	mem◇
◇wv00	03872	
◇wv01	00128	

If the power-on setting has been set to restore last setup on the POWER ON SETTING screen the waveforms will be restored to the channel's memory at power-on. Refer to chapter 14, *System Operations from the Utility Menu* for more information.

The same arbitrary waveform can be selected to run on more than one channel; in this case, when it is edited in backup memory, the changes will also be applied to all copies of the waveform.

The following sections give full details as to how arbitrary waveforms are created and modified.

Creating New Waveforms

Pressing the **CREATE** key calls the CREATE NEW WAVEFORM screen.

CREATE NEW WAVEFORM
free memory: 258972
◇create blank...
◇create from copy...

Create Blank Waveform

Pressing the **create blank...** soft-key calls the menu:

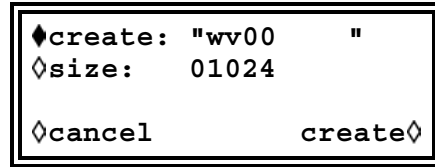

The top line contains the user-defined waveform name which can be up to 8 characters long. The instrument allocates a default name of `wv(n)` starting at `wv00`; the name can be edited by selecting the appropriate character position with the cursor keys and then setting the character with the rotary control which scrolls through all alphanumeric characters in sequence.

Pressing the `size` soft-key permits the waveform length to be entered directly from the keyboard or by using the rotary control and cursor keys. 1024 points is the default size and the range is from 4 to 65,536 points. Screen messages will tell you if you have attempted to set values less than 4 or greater than the remaining available backup memory. The waveform 'blank' is created in the non-volatile backup memory and the `free memory` field shows the remaining unused backup memory.

The `cancel` soft key causes the name to be kept without any allocation of memory space. Pressing the `create` soft key allocates both the name and the memory, and calls the `MODIFY` screen to permit waveform editing.

Create Waveform Copy

Pressing the `create` from `copy...` soft-key calls the following menu:

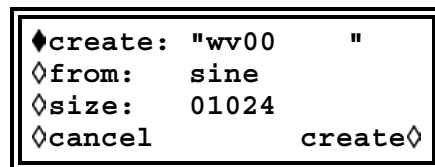

The user-defined name and waveform size can be entered after pressing the `create` and `size` soft-keys respectively, exactly as described in the previous section.

The source waveform which is to be copied can be selected by the `from` soft key; repeated presses of the key, cursor keys or using the rotary control will scroll through the list of all the available waveforms, including any other arbitrary waveforms already created.

The horizontal size of the waveform being copied does not have to be the same as the waveform being created. When the waveform is copied by pressing the `create` key, the software compresses or expands the source waveform to create the copy. When the source is expanded the copy has additional interpolated points; when the source is compressed it is possible to lose significant waveform, particularly from arb waveforms with narrow spikes if the compression ratio is large.

The `cancel` soft key causes the name to be kept without any allocation of memory space. Pressing the `create` soft key allocates both the name and the memory, and calls the `MODIFY` screen to permit waveform editing.

Modifying Arbitrary Waveforms

Certain restrictions apply to waveform modification. They are summarized at the head of this chapter.

Pressing the **MODIFY** front panel key, or the `create` soft-key on either of the `CREATE NEW WAVEFORM` menus calls the `MODIFY` screen:

```

┌───────────────────────────────────────────────────────────────────────────────────┐
│ ▲MODIFY:      vwv01                                                              │
│ ◇resize...      rename...◇                                                       │
│ ◇delete...      info...◇                                                         │
│ ◇edit waveform                                                                               │
└───────────────────────────────────────────────────────────────────────────────────┘

```

This screen gives access to a number of menus which permit the selected waveform to be resized, renamed, edited, etc. The arb waveform to be modified is selected using the rotary control or cursor keys to step through all possible choices; the current choice is displayed on the top line beside `MODIFY`.

Waveform Edit Cursor

During any arbitrary waveform modify procedure which involves setting waveform addresses, one or more waveform cursors can be output from the rear panel **CURSORMARKER OUT** socket. The waveform being edited must be running on the output currently selected by the channel **SETUP** keys. The amplitude, polarity and width of the cursor is set on the `cursor/marker...` menu of the `UTILITY` screen as described chapter 14, *System Operations from the Utility Menu*. The cursors are positioned at the start and stop addresses used for the various edit operations described below (one address per cursor only for point edit). The cursor signal can be displayed on a second channel of the oscilloscope or used to modulate the Z-axis to highlight the stop and start addresses.

Note that the addresses are retained when moving between edit functions. Thus if the stop and start addresses are set for waveform insert, the same addresses appear as the defaults when wave amplitude edit is selected, for example. The addresses can of course be changed subsequently.

Resize Waveform

Pressing the `resize...` soft-key on the `MODIFY` screen calls the `Resize` screen:

```

┌───────────────────────────────────────────────────────────────────────────────────┐
│ Resize:      vwv01                                                                │
│ (old size:  01024)                                                                │
│   new size:  01024                                                                │
│ ◇cancel      resize◇                                                             │
└───────────────────────────────────────────────────────────────────────────────────┘

```

Resize changes the number of points in the waveform. The new size can be larger or smaller than the old size. When the new size is larger the software adds additional interpolated points. When the new size is smaller points are removed. Reducing the waveform size may cause the waveform to lose significant data; be careful, because there is no "undo" for resize.

Resize is implemented by pressing the `resize` soft-key. The `cancel` soft-key leaves the size unchanged. Both soft keys return the display to the `MODIFY` screen.

Rename Waveform

Pressing the `rename...` soft-key on the `MODIFY` screen calls the `Rename` screen:

```

Rename:   vwv01
         as:  "myWave01"
◇cancel           rename◇
    
```

The new name can be entered below the original by selecting the appropriate character position with the cursor keys and then setting the character with the rotary control which scrolls through all the alphanumeric characters in sequence. The name can be up to eight characters long.

Rename is completed by pressing the `rename` soft-key. The `cancel` soft-key leaves the name unchanged. Both soft keys return the display to the `MODIFY` screen.

Waveform Info

Pressing the `info...` soft-key on the `MODIFY` screen calls the `info` screen.

```

Info vwv03           exit◇
length:  00128
chan:    3 4
seq:
    
```

The screen gives the name of the waveform, its length and the channels and sequences where it is used. The "where used" information is particularly important when executing waveform management operations such as delete.

Pressing `exit` returns the display to the `MODIFY` screen.

To view what waveforms are held in a particular channel memory, select the channel with its **SETUP** key, press the **UTILITY** key to view the `UTILITY MENU` and then press the `chan wfm info...` soft-key to get the `CHANNEL WFM INFO:` screen:

```

CHANNEL WFM INFO:
waveforms:  1
Free mem:   65436
                    exit◇
    
```

This shows the number of waveforms and the free memory on that channel. Press the `exit` soft-key to return to the `UTILITY MENU`.

Delete Waveform

Pressing the `delete...` soft-key displays a request for confirmation that the selected waveform is to be deleted from the backup memory.

```

Delete waveform
"wav01"
?
◊cancel          delete◊

```

Confirm deletion by pressing the `delete` soft-key which will return the display to the `MODIFY` screen with the next arb waveform automatically selected; the `cancel` soft key aborts the deletion.

A waveform cannot be deleted from the backup memory until it has first been deleted from all channel memories.

A waveform cannot be deleted from a channel's memory if it is being output on that channel. The waveform must first be deselected by selecting an alternative waveform. Make the new selection using either the `STANDARD WAVEFORMS` or the `ARBS` screen.

You will then be able to delete the waveform from the channel memory by selecting the `ARBS` screen for that channel.

```

ARBS:          chan mem◊
◊wav00        01024 del◊
◆wav01        03872
◊wav02        00500 del◊

```

A `del` soft-key will appear against those waveforms in the channels memory which are not in use. Press the appropriate `del` soft-key to delete the waveform from channel memory. You can then complete the deletion from backup memory as described above.

Edit Waveform

Pressing the `edit waveform...` soft-key calls the `EDIT FUNCTIONS` menu:

```

EDIT FUNCTIONS:
◊point edit...
◊line draw...
◊wave insert...◊

```

From this menu you can select functions which permit you to edit the waveform point-by-point (point edit), by drawing lines between two points (line draw) or by inserting all or part of an existing waveform into the waveform being edited (wave insert). In addition, sections of the waveform can be selected and their peak-to-peak level changed using wave amplitude, or their baseline can be changed using wave offset. Sections of the

waveform can be copied into itself (block copy) and position markers for use at **SYNC OUT** can also be defined.

Pressing the `exit` soft-key on any of these edit screens will return the display to the **EDIT FUNCTIONS** menu.

Point Edit

Press the `point edit...` soft-key to call the **POINT EDIT** screen:

```

POINT EDIT
  (addrs, value)
◆ (00512, +0500) ◆
◆exit      next point◆
    
```

To see the data value at a point, press the soft-key on the left adjacent to the numeric address and enter the point address directly from the keyboard or by using the rotary control. The current data value is displayed to the right of the address.

To change the value press the soft key on the right adjacent to the numeric value and enter the new value directly from the keyboard or by using the rotary control. Changing the data value automatically updates the waveform.

Pressing the `next point` soft-key automatically advances the address by one point.

Line Edit

Press the `line draw...` soft-key to call the **LINE** screen:

```

LINE (addrs, value)
◆frm (00512, +0500)◆
◆to (00750, +0412)◆
◆exit      draw line◆
    
```

The display shows a `frm` (from) and `to` address which will be the points between which a straight line will be created when the `draw line` soft-key is pressed. The default `frm` address is the first point on the waveform or the point most recently edited if point edit has been used.

Set the "from" address and value by pressing the appropriate soft-key and making an entry direct from the keyboard or by using the rotary control; repeat for the "to" address and value.

The linear interpolations will be calculated for the addresses between the two selected points when the `draw line` soft-key is pressed.

Wave Insert

Pressing `wave insert...` calls the wave insert screen:

```

↕wv01      →  wv02
◇ 00000 strt  00400 ◇
◇ 00512 stop  01000 ◇
◇exit        insert◇

```

Wave insert places waveforms between programmable start and stop points. Both standard and arbitrary waveforms can be inserted in the new waveform, with the exception of pulse, pulse-train and sequence.

You can insert a section of an arbitrary waveform, defined by the left-hand `strt` (start) and `stop` addresses, for example points 00000 to 00512 of `wv01` on the screen above. These start and stop addresses default to the start and stop addresses of the entire waveform being inserted, but you can adjust the addresses to define any section of the waveform.

Change the addresses by pressing the appropriate soft-key and making entries from the keyboard or by rotary control.

The destination of the selected section of the source waveform in the new waveform is defined by the right-hand `strt` and `stop` addresses. Again, change the addresses by pressing the appropriate soft-key and making entries from the keyboard or by rotary control.

The insertion is completed by pressing the `insert` soft-key.

If there is a size difference between the two sections of waveform then the software will expand or compress the source address space to fit the new waveform. As before, compressing the waveform may cause you to lose some significant data.

To insert sections of the current waveform within itself see the next section, *Block Copy*.

Block Copy

Pressing `block copy...` calls the `BLOCK COPY` screen:

```

BLOCK COPY:   execute◇
◆start: 00400  exit◇
◇stop: 01000  undo◇
◇dest: 00000  save◇

```

Block copy allows a section of the current waveform to be inserted within itself. The block to be inserted is defined by the `start` and `stop` addresses. Change the addresses by pressing the appropriate soft-key and making entries from the keyboard or by rotary control.

The destination address for the start of the section is set by pressing the `dest` soft-key and entering the address. The effect of making the block copy can then be previewed by pressing the `execute` soft-key.

Note that if there are not enough waveform points between the destination address and end of waveform to accommodate the copied section, the waveform being copied will simply be truncated. The copy can be removed by pressing the `undo` soft-key or by entering a new destination address.

Block copy edit operates on the version of the waveform in the channel currently selected by the channel **SETUP** keys, and the effect of the edit can be seen by selecting the waveform to run on that channel.

When your waveform is ready it can be saved by pressing the `save` soft-key; the action of saving modifies the waveform in the backup memory and also any other copies of the waveform in other channel memories. After the edited waveform has been saved the original waveform cannot be recovered.

Pressing the `exit` soft key returns to the `EDIT FUNCTIONS` screen without saving any changes.

Waveform Amplitude

Pressing the `wave amplitude` soft-key calls the `AMPLITUDE` screen:

```

    AMPLITUDE:      001.00◆
    ◇start: 00400
    ◇stop:  01000   undo◇
    ◇exit         save◇
    
```

The waveform amplitude can be changed on a section of the waveform defined by the `start` and `stop` addresses. Set the addresses by pressing the appropriate soft-key and making entries directly from the keyboard or by rotary control.

The data values over the specified section of the waveform can be multiplied by a factor of between 0.01 and 100.0 by making entries in the `AMPLITUDE` field. Press the appropriate soft-key and make entries directly from the keyboard or by using the rotary control. The amplitude changes on completion of the entry. Note that entries greater than 1.0 will cause clipping if the waveform already uses the full -2048 to +2047 data value range; the result is, however, still treated as a valid waveform. The original waveform can be restored by pressing the `undo` soft-key.

Amplitude edit operates on the version of the waveform in the channel currently selected by the channel **SETUP** keys; the effect of the edit can be seen by selecting the waveform to run on that channel. When the amplitude has been modified as required the new waveform can be saved by pressing the `save` soft key; the action of saving modifies the waveform in the backup memory and also any other copies of the waveform in other channel memories. After the edited waveform has been saved the original waveform cannot be recovered.

Pressing the `exit` soft key returns to the `EDIT FUNCTIONS` screen without saving any changes.

Waveform Offset

Pressing the `wave offset` soft-key calls the `WAVE OFFSET` screen.

```

    WAVE OFFSET:   +0000◆
    ◇start: 00400
    ◇stop:  01000   undo◇
    ◇exit         save◇
    
```

The waveform offset can be changed on a section of the waveform defined by the `start` and `stop` addresses. Set the addresses by pressing the appropriate soft-key and making entries directly from the keyboard or by using the rotary control.

The data values over the specified section of the waveform are offset by the value entered in the `WAVE OFFSET` field. Press the appropriate soft-key and make entries directly from the keyboard or by using the rotary control. Entries in the range -4096 to +4095 will be accepted; this permits, in the extreme, waveform sections with values at the -2048 limit to be offset to the opposite limit of +2047. Warnings are given when the offset causes clipping, although the entry is still accepted. The original waveform can be restored by pressing the `undo` soft-key.

Offset edit operates on the version of the waveform in the channel currently selected by the channel **SETUP** keys; the effect of the edit can be seen by selecting the waveform to run on that channel. When the offset has been modified as required the new waveform can be saved by pressing the `save` soft key; the action of saving modifies the waveform in the backup memory and also any other copies of the waveform in other channel memories. After the edited waveform has been saved the original waveform cannot be recovered.

Pressing the `exit` soft key returns to the `EDIT FUNCTIONS` screen without saving any changes.

Wave Invert

Pressing the `wave invert` soft-key calls the `INVERT` screen:

```
INVERT:      wv02
◆start adrs: 00512
◇stop adrs:  00750
◇exit        invert◇
```

The inversion can be applied to a section of the waveform defined by the `start` and `stop` addresses. Set the addresses by pressing the appropriate soft-key and making entries directly from the keyboard or by using the rotary control.

The data values over the specified section of the waveform are inverted about 0000 each time the `invert` soft-key is pressed.

Press `exit` to return to the `EDIT FUNCTIONS` screen.

Position Markers

Pressing the `position markers...` soft-key calls the `POSITION MARKER EDIT` screen:

```
POSITION MARKER EDIT
adrs: 00000      <0>◇
◇patterns...
◇exit          clear all◇
```

Position markers are output from the **SYNC OUT** socket when the source `src` is set to `pos'n marker` on the `SYNC OUTPUT SETUP` screen.

Position markers can be set at any or all of the addresses of a waveform either individually, using the `adrs` (address) soft-key, or as a pattern, using the `patterns...` menu.

A marker can be set directly at an address by pressing the `adrs` soft-key followed by a keyboard entry. Pressing the right-hand soft-key on the `adrs` line then toggles the marker setting between `<1>` and `<0>`. The address can be changed by incrementing with the `adrs` key, by using the rotary control, or by further keyboard entries; marker settings are changed at each new address with the right-hand soft-key. Markers show immediately they are changed.

Alternatively, markers can be input as patterns by using the `patterns...` sub-menu:

```

PATTERN:      00000000...
◊start:      00000
◊stop:       01023
◊exit:       do pattern◊
```

The start and stop addresses of the markers within the waveform are set using the `start` and `stop` soft-keys respectively followed by a direct keyboard entry or by using the rotary control.

The pattern itself is set in the top line of the display; press the soft-key to the right of `PATTERN:` and enter the sequence of 1s and 0s using **1** and **0** from the keyboard (which auto-increments to the next character) or with the rotary control (using the cursor keys to move the edit cursor along the pattern).

The pattern consists of 16 values; if the cursor keys are used to skip over some character positions these will automatically be filled with the value of the last one specified to the left.

The pattern is entered repeatedly across the whole range defined by the start and stop addresses when the `do pattern` soft-key is pressed; pressing `exit` returns to the POSITION MARKER EDIT screen without implementing the pattern.

Pressing the `clear all` soft-key displays a request for confirmation that all markers should be cleared from the waveform. Pressing `clear` cancels all the markers and returns the display to POSITION MARKER EDIT; pressing `cancel` aborts the clear.

Arbitrary Waveform Sequence

Up to 16 arbitrary waveforms may be linked in a sequence. Each waveform can have a loop count of up to 32,768 and the whole sequence can run continuously or be looped up to 1,048,575 times using the triggered burst mode.

Pressing the **SEQUENCE** key calls the initial `SEQUENCE` screen:

```

SEQUENCE (segs= 1)
◊sequence setup...

◊stop                               run◊
```

A previously defined sequence can be run and stopped from this screen using the `run` and `stop` soft-keys. The sequence can also be switched on from the `STANDARD WAVEFORMS` screen with the `sequence` soft-key.

The `segs=` field shows the number of segments in the sequence; there is always at least 1 segment.

Sequence Set-up

Pressing the `sequence setup...` soft-key on the `SEQUENCE` screen (or the `setup...` soft-key next to `sequence` on the `STANDARD WAVEFORMS` screen) calls the sequence set up screen:

```

◇seg: 2                off◇
◆wfm wv03
◇step on: count
◇cnt: 00001          done◇

```

Repeated presses of the `seg` soft-key steps the display through the set-ups of each of the 16 segments of the sequence. With the exception of segment 1 which is always on (and therefore has no on-off soft-key) the 16 segment set-ups are identical in format. When segment 1 is displayed the `segs=` field shows the total number of segments in the current sequence.

The segment to be set up is selected with the `seg` soft-key; the 16 segments can be selected in sequence with repeated presses of the soft-key or by using the rotary control.

Once the segment to be edited has been set the waveform for that segment is selected with the `wfm` (waveform) soft-key; the list of all arbitrary waveforms already created is stepped through with repeated presses of the `wfm` soft-key or by using the rotary control.

The criterion for stepping between waveform segments is set by the `step on` soft-key. The default setting is `step on: count` which means that the waveform will step on to the next segment after the number of waveform cycles specified in the `cnt` (count) field; up to 32,768 cycles can be set with `cnt` selected, using direct keyboard entries or by rotary control.

Alternatively, the `step on` criterion can be set to `trig edge` or `trig level` in the `step on` field; trigger edge or trigger level can be mixed with count (i.e. some segments can step on count, others on the specified trigger condition) but trigger edge cannot be mixed with trigger level in the same sequence.

If `trig edge` is selected the sequence starts running at the first waveform segment when sequence is set to `run` and steps to the following segments in turn at each subsequent trigger. The trigger source can be any of the settings selected on the `TRIGGER IN` set-up screen (called by the **TRIG IN** key); these are described fully in chapter 7, *Triggered Burst and Gate*. At each trigger the current waveform cycle plus one further whole cycle are completed before the waveform of the next segment is started.

If `trig level` is selected the sequence runs continuously through each segment in turn (one cycle per segment) while the trigger level is true. When the trigger level goes false the waveform currently selected runs continuously until the level goes true again at which point the sequence again runs continuously through each segment in turn. The trigger level source can be any of the settings selected on the `TRIGGER IN` set-up

screen with the exception of the **MAN TRIG** key (which when pressed can only produce an edge, not a level).

Providing the `step on:` field is set to `count` for all segments the waveform sequence can also be run in gated and triggered burst modes in the same way as simple waveforms. Refer to chapter 7, *Triggered Burst and Gate* for full details.

The individual segments of the sequence can be turned on or off with the `on-off` soft-key. Note that turning a segment off will automatically set all subsequent segments off; turning a segment on will also turn on any others between segment 1 and itself that were previously off. Segment 1 is always on.

When the whole sequence is defined the set-up is constructed by pressing the `done` soft-key which returns the display to the initial `SEQUENCE` screen. The sequence can be run and stopped from this screen with the `run` and `stop` soft-keys respectively.

Frequency and Amplitude Control with Arbitrary Waveforms

Frequency and Amplitude control work in essentially the same way as for standard waveforms with the following minor differences.

Frequency

Pressing the **FREQ** key with an arbitrary waveform selected calls the `ARBITRARY FREQUENCY` screen:

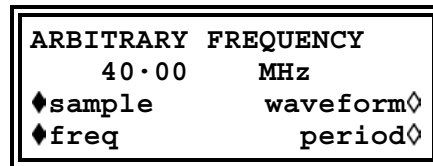

You can set either the frequency or the period, as before, by pressing the `freq` or `period` soft-key respectively. Note that the frequency and period resolution in arbitrary mode is only 4 digits because clock synthesis generation is used. The *Principles of Operation* section in chapter 4, *Initial Operation*, provides an explanation of the synthesis technique used.

Additionally, for arbitrary waveforms, frequency or period can be set in terms of the sample clock frequency, by pressing the `sample` soft-key, or in terms of the waveform frequency, by pressing the `waveform` soft-key. The relationship between them is

$$\text{waveform frequency} = \text{sample frequency} \text{ divided by waveform size.}$$

Frequency and period entries are made directly from the numeric keypad or by using the rotary control in the usual way.

Pressing the **FREQ** key with sequence selected calls the `SEQ CLOCK FREQUENCY` screen:

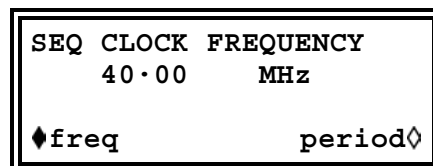

Frequency or period can now only be set in terms of the clock frequency. Frequency and period entries are made directly from the numeric keypad or by using the rotary control in the usual way.

Amplitude

Pressing the **AMPL**itude key with an arbitrary waveform selected calls the `AMPLITUDE` screen:

```
AMPLITUDE:
+20.0 Vpp
◆Vpp
load:hiZ◇
```

This differs from the `AMPLITUDE` screen for standard waveforms in that amplitude can now only be entered in volts peak-to-peak.

Note that the peak-to-peak amplitude set on this screen will only be output if the arbitrary waveform has addresses with values which reach -2048 and +2047; if the maximum value range is -1024 to +1023 for example then the output range with the instrument set to 20 V p-p will only be 10 V p-p.

Sync Out Settings with Arbitrary Waveforms

The default setting for sync out when arbitrary waveforms are selected is `waveform sync`; this is a pulse that starts coincident with the first point of the waveform and is a few points wide.

If a waveform sequence has been selected then sync out defaults to `sequence sync`; this is a waveform which goes low during the last cycle of the last waveform in a sequence and is high at all other times. When sequence is used in triggered burst mode the burst count is a count of the number of complete sequences.

Waveform Hold in Arbitrary Mode

Arbitrary waveforms can be paused and restarted on any channel by using the front panel **MAN HOLD** key or a signal applied to the rear panel **HOLD IN** socket.

On multi-channel instruments the channels which are to be held by the **MAN HOLD** key or **HOLD IN** socket must first be enabled using the `ARB HOLD INPUT` screen, accessed by pressing the **HOLD** key:

```
ARB HOLD INPUT:
status: no hold
◆mode: disabled
```

Each channel is selected in turn using the channel **SETUP** keys and set using the `mode` soft-key; the mode changes between `disabled` and `enabled` with alternate key presses.

Pressing the front panel **MAN HOLD** key stops the waveform at the current level on all enabled channels; pressing **MAN HOLD** a second time restarts the waveform from that level. If the `ARB HOLD INPUT` screen is currently selected the `status` field will change from `no hold` to `manual hold` while the waveform is paused.

A logic low or switch closure at the rear panel **HOLD IN** socket also stops the waveform at the current level on all enabled channels; a logic high or switch opening restarts the waveform from that level. If the `ARB HOLD INPUT` screen is currently selected the `status` field will change from `no hold` to `ext. hold` while the waveform is paused.

If, while the waveform is held by either of the above means, the **MAN TRIG** key is pressed the waveform is reset to its first point; the waveform will restart from this point when **MAN HOLD** is pressed again or a high is applied to the rear panel **HOLD IN** socket.

Output Filter Setting

The output filter type is automatically chosen by the software to give the best signal quality for the selected waveform. The choice can, however, be overridden by the user and this may be a frequent requirement with arbitrary waveforms.

To change the filter settings, press the **FILTER** key to call the `FILTER SETUP` screen:

```

FILTER SETUP

mode: auto
type: 10MHz elliptic
```

The default `mode` is `auto` which means that the software selects the most appropriate filter. With the setting on `auto` the `type` can be changed manually but the choice will revert to the automatic selection as soon as any relevant parameter is changed.

To override the automatic choice press the `mode` soft-key to select `manual`.

The four filter choices, which are either automatically selected or set manually with the type soft-key, are as follows:

- 10 MHz elliptic: The automatic choice up to 10 MHz for sine, cosine, haversine, havercosine, $\sin(x)/x$ and triangle. Would be the better choice for arb waveforms with an essentially sinusoidal content.
- 16 MHz elliptic: The automatic choice above 10 MHz for sine, cosine, haversine and havercosine. Not recommended for any other waveforms.
- 10 MHz Bessel: The automatic choice for positive and negative ramps, arb and sequence.
- No filter: The automatic choice for square wave, pulse and pulse trains. May be the best choice for arb waveforms with an essentially rectangular content.

Chapter 10

Pulse and Pulse-trains

Introduction.....	10-2
Pulse Set-up	10-2
Pulse-Train Set-up	10-4
Waveform Hold in Pulse and Pulse-Train Modes	10-6

Introduction

Pulse and pulse-trains are both selected and set-up from independent menus on the STANDARD WAVEFORMS screen called by pressing the **STD** key. Pulse and pulse-trains have similar timing set-ups and considerations but pulses are always unipolar, with a maximum amplitude of 10 V p-p, whereas pulse-trains can be bipolar, with a maximum amplitude of 20 V p-p.

Pulse Set-up

Pulse waveforms are turned on with the `pulse` soft-key on the STANDARD WAVEFORMS screen. Pressing the `setup...` soft-key beside `pulse` calls the first of the pulse set-up screens:

```

Enter pulse period:
  100.0 us
◇exit                next◇
  
```

The pulse period can be set between 100.0 ns and 100 s, with 4-digit resolution, by direct entries from the numeric keypad or by using the rotary control. Pressing the `next` soft-key calls the pulse width screen:

```

Enter pulse width:
program 50.00 us
(actual 50.00 us)
◇exit                next◇
  
```

The width can be entered directly from the numeric keypad or by using the rotary control. Any value in the range 25.00 ns to 99.99 s can be programmed but the `actual` value may differ because of the considerations discussed below; for this reason the `actual` pulse width is shown below the `program` width.

Pressing the `next` soft-key calls the pulse delay screen:

```

Enter pulse delay:
program 0.000 ns
(actual 0.000 ns)
◇exit                done◇
  
```

This is very similar to the pulse width screen and, again, the `actual` delay is shown below the `program` delay. The delay value that can be entered must be in the range \pm (pulse period -1 point); positive values delay the pulse output with respect to waveform sync from **SYNC OUT**; negative values cause the pulse to be output before the waveform sync.

Pressing the `done` soft-key on this screen returns the display to the STANDARD WAVEFORMS screen.

The means by which pulse period is set-up in the hardware requires an understanding because it affects the setting resolution of both pulse width and delay. Pulse is actually a particular form of arbitrary waveform made up of between 4 and 50,000 points; each point has a minimum time of 25.00 ns corresponding to the fastest clock frequency of 40 MHz.

At short pulse periods, i.e. for waveforms with a small number of points, the setting resolution is, however, much better than 25.00 ns because the time-per-point is adjusted as well as the number of points; since the pulse width and delay are also defined in terms of the same point time, varying the time-per-point affects their resolution.

For example, if the period is set to 500 ns, the minimum pulse width, when set to 25.00 ns, will in fact be 25.00 ns; 20 points at 25.00 ns each exactly defines the 500 ns period. However, if the period is set to 499.0 ns, 20 points at the minimum point time of 25.00 ns will be too long so 19 points are used and the point time is adjusted to 26.26 ns (499.0/19); 26.26 ns is now the increment size used when changing the pulse width and delay.

For periods above 1.25 ms the maximum number of points in the waveform (50,000) becomes the factor determining pulse width and delay resolution. For example, with the period set to 100 ms, the smallest pulse width and delay increment is 2 μ s (100 ms/50,000). This may appear to cause significant errors at extreme settings (for example, setting 100 ns in the above case will still give an actual width of 2 μ s) but in practical terms a 1 in 50,000 resolution (0.002%) is normally acceptable.

The pulse period can be adjusted irrespective of the pulse width and delay setting (for example it can be set smaller than the programmed pulse width) because, unlike a conventional pulse generator, pulse width and delay are adjusted proportionally as the period is changed. For example, if, from the default pulse settings of 100 μ s period and 50 μ s width, the period is changed to 60 μ s the pulse width *actual* changes to 30 μ s even though the *program* width is still 50 μ s. To get a 50 μ s width with the period at 60 μ s the width must be re-entered as 50 μ s after the period has been changed.

Period can also be changed from the PULSE PERIOD screen, called by pressing the **FREQ** key with pulse mode selected:

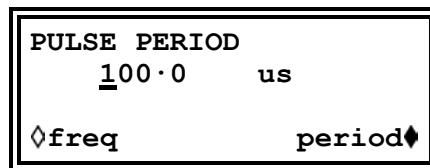

The new setting can be entered either as a period in the way already described or as a frequency by first pressing the *freq* soft-key. However, changing the period or frequency from this screen is slightly different from changing period on the *pulse setup* screen. When changing from this screen the number of points in the waveform is never changed (just as with a true arb) which means that the shortest period that can be set is the number of waveform points times 25.00 ns. To achieve faster frequencies (up to the specification limit) the period must be changed from the pulse set-up screen; changing the frequency from this screen causes the number of points to be reduced as the period is reduced (for periods less than 1.25 ms).

Pulse-Train Set-up

Pulse-trains are turned on with the `pulse-train` soft key on the STANDARD WAVEFORMS screen; pressing the `setup...` soft-key beside `pulse-train` calls the first of the set-up screens:

```

Enter no of pulses
in train (1-10):
      2
◇done                next◇
  
```

The number of screens used for the set-up depends on the number of pulses in the pulse-train. The first three screens define the parameters that apply to the whole pattern (number of pulses, overall pulse-train period and baseline voltage). Subsequent screens define the pulse level, width and delay for each pulse in turn (three screens for pulse 1, then three screens for pulse 2, etc.).

Pressing the `next` soft key on any screen calls the next set-up screen, finally returning the display to the STANDARD WAVEFORMS screen from which pulse-train can be turned on and off.

Pressing the `done` soft key returns the display directly to the STANDARD WAVEFORMS screen from any set-up screen.

The pulse-train is built only after the `next` soft key is pressed following the final parameter set-up screen, or whenever `done` is pressed (always assuming a change has been made).

The first screen, shown above, sets the number of pulses (1-10) in the pattern; enter the number of pulses directly from the numeric keypad or by using the rotary control.

Pressing `next` calls the pulse train period screen:

```

Enter pulse train
period:
      100·0us
◇done                next◇
  
```

The period can be set, with 4-digit resolution, from 100.00 ns to 100 s by direct numeric keypad entries or by using the rotary control.

Pressing `next` calls the baseline voltage screen, the last of the general set-up screens:

```

Enter the baseline
voltage:
      0·000 V
◇done                next◇
  
```

The baseline is the signal level between the end of one pulse and the start of the next, i.e. it is the level at which all pulses start and finish. The baseline can be set between -5.0 V and +5.0 V by direct numeric keypad entries or by using the rotary control.

Note that the actual baseline level at the output will only be as set in this field if the output amplitude is set to maximum (10 V p-p into 50 Ω) on the `AMPLITUDE` screen and terminated in 50 Ω. The amplitude control scales the baseline setting, so that if, for example, the amplitude were set to 5 V p-p into 50 Ω then the actual baseline range would be -2.5 V to +2.5 V for set values of -5.0 V to +5.0 V.

Note also that the output levels are doubled when the output is not terminated.

Pressing `next` on this screen calls the first of 3 screens for the first pulse in the pattern:

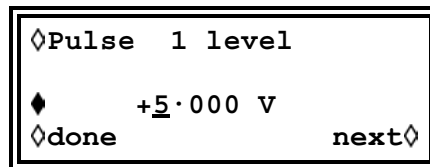

The pulse level can be set on this screen between -5.0 V and +5.0 V by direct numeric keypad entries or by using the rotary control. As with the baseline level described above the set pulse levels are only output if the amplitude setting is set to maximum (10 V p-p into 50 Ω) on the `AMPLITUDE` screen and terminated in 50 Ω. Adjusting the amplitude scales both the peak pulse levels and the baseline together, thus keeping the pulse shape in proportion as the amplitude is changed, exactly as for arb waveforms.

Note also that the output levels are doubled when the output is not terminated.

By pressing the `Pulse` soft-key on this (and subsequent) screens, the pulse to be edited can be directly selected using the numeric keypad or the rotary control. This is useful for editing a particular pulse in a long pulse train without needing to step through all the earlier pulses.

Pressing `next` then calls the pulse width screen for the first pulse:

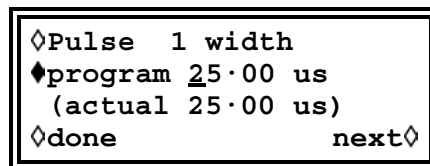

The width can be entered directly from the numeric keypad or by using the rotary control. Any value in the range 25.00 ns to 99.99 s can be programmed but the `actual` value may differ; for this reason the `actual` pulse width is shown below the `program` width. The variation between `program` and `actual` will only really be noticeable for very short pulse-train periods (only a few points in the pulse-train) and very long periods (each of the 50,000 points has a long dwell time) for exactly the same reasons as described in the *Pulse Set-up* section.

Pressing `next` calls the pulse delay screen for the first pulse:

```

◇Pulse 1 delay
◆program +0.000 ns
  (actual +0.000 ns)
◇done                next◇

```

The pulse delay is entered in the same way as the pulse width and, again, the actual delay is shown below the program delay for the same reasons. The delay value that can be entered must be in the range \pm (pulse-train period -1 point); positive values delay the pulse with respect to waveform sync from **SYNC OUT**; negative values cause the pulse to be output before the waveform sync.

Pressing `next` on this screen calls the first of the three screens for setting the parameters of Pulse 2, and so on through all the pulses in the pulse-train. In this way all parameters of all pulses are set. The pulse-train is built when `next` is pressed on the last screen of the last pulse or when `done` is pressed on any screen.

You must be careful to ensure that the set widths and delays of the individual pulses are compatible with each other and with the overall pulse-train period. Thus delays must not be such that pulses overlap each other and the delays plus widths must not exceed the pulse-train period; unpredictable results will occur if these rules are not followed.

Once the pulse-train has been defined the period can be adjusted irrespective of the pulse width and delay settings for the individual pulses because, unlike a conventional pulse generator, the individual pulse widths and delays are adjusted proportionally to the period as the period is changed.

Period can also be changed from the `PULSE-TRN PERIOD` screen called by pressing the **FREQ** key with pulse-train mode selected:

```

PULSE-TRN PERIOD
  100.0us
◇done                next◇

```

The new setting can be entered either as a period in the way already described, or as a frequency by first pressing the `freq` soft-key. However, changing the period or frequency from this screen is slightly different from changing the period on the `pulse-train setup` screen. When changing from this screen the number of points in the waveform is never changed (just as with a true arb) which means that the shortest period that can be set is the number of waveform points times 25.00 ns. To achieve higher frequencies (up to the specification limit) the period must be changed from the pulse set-up screen; changing the frequency from this screen causes the number of points to be reduced as the period is reduced (for periods less than 1.25 ms).

Waveform Hold in Pulse and Pulse-Train Modes

Pulse and pulse-train waveforms can be paused and re-started on any channel by using the front panel **MAN HOLD** key or a signal applied to the rear panel **HOLD IN** socket.

On multi-channel instruments the channels which are to be held by the **MAN HOLD** key or **HOLD IN** socket must first be enabled using the `ARB HOLD INPUT` screen, accessed by pressing the **HOLD** key:

```
ARB HOLD INPUT:  
  
status: no hold  
mode: disabled
```

Each channel is selected in turn using the channel **SETUP** keys and set using the mode soft-key. The mode changes between disabled and enabled with alternate key presses.

Pressing the front panel **MAN HOLD** key stops the waveform at the current level on all enabled channels; pressing **MAN HOLD** a second time restarts the waveform from that level. If the ARB HOLD INPUT screen is currently selected the status field will change from no hold to manual hold while the waveform is paused.

A logic low or switch closure at the rear panel **HOLD IN** socket also stops the waveform at the current level on all enabled channels; a logic high or switch opening restarts the waveform from that level. If the ARB HOLD INPUT screen is currently selected the status field will change from no hold to ext hold while the waveform is paused.

Chapter 11

Modulation

Introduction.....	11-2
External Modulation	11-2
External VCA	11-2
External SCM	11-3
Internal Modulation	11-3

Introduction

You can use both internal and external modulation sources. External modulation can be applied to any or all channels. Internal modulation uses the previous channel as the modulation source; for example channel 2 can be used to modulate channel 3. Clearly, internal modulation is not available on channel 1 or on a single channel instrument.

The external modulation mode can be either VCA (voltage controlled amplitude) or SCM (suppressed carrier modulation). The internal modulation mode can be either true AM (amplitude modulation) or SCM.

Modulation modes share some of the generator's inter-channel resources with sum modes; as a result there are some restrictions on using modulation and sum together but they are generally outside the range of common-sense applications. To better understand these constraints the following sections (and chapter 12, *Sum*) should be read with reference to the block diagrams in appendix F. These show the control signals in a single channel and the inter-channel connections.

The block diagrams also show the inter-channel trigger connections described in chapter 7, *Triggered Burst and Gate*; in general, inter-channel triggering is possible simultaneously with modulation but few combinations are of real use.

External Modulation

Pressing the **MODULATION** key calls the `MODULATION` set-up screen:

```

MODULATION
↑source: ext
◇type: VCA
  
```

The `source` soft-key steps the modulation choice between `off`, `external` and `CHx` where `x` is the number of the previous channel; this last choice is not available on single channel instruments or on channel 1 of multi-channel instruments.

With `ext` selected the modulation can be switched between `VCA` and `SCM` with alternate presses of the `type` soft-key. Both types of external modulation can be used with internal or external sum.

External modulation can be applied to any or all channels.

External VCA

Select `VCA` with the `type` soft-key on the `MODULATION` screen. Connect the modulating signal to the **EXT MODULATION** socket (nominally 1 k Ω input impedance). A positive voltage increases the channel output amplitude and a negative voltage decreases the amplitude. Note that clipping will occur if the combination of channel amplitude setting and VCA signal attempts to drive the output above 20 V p-p open-circuit voltage.

External AM is achieved by setting the channel to the required output level and applying the modulation signal (which can be ac coupled if required) at the appropriate level to obtain the modulation depth required. If the channel output level is changed the amplitude of the modulating signal must also be changed to maintain the same modulation depth.

The VCA signal is applied to the amplifier chain prior to the output attenuators. The amplifier itself is controlled over a limited range (approximately 10 dB); the full amplitude range of the channel is achieved by switching in up to five 10 dB attenuation stages. Peak modulation cannot exceed the maximum of the range within which the channel output has been set by choice of amplitude setting. Whereas with internal AM the generator gives warnings when the combination of modulation depth and amplitude setting cause waveform clipping (see *Internal Modulation* below), it is up to the user to observe the waveforms when using externally-driven VCA and to make adjustments to prevent clipping. Note that it is not possible to give a simple guide as to where the range clipping limits are because the use of dc offset, for example, changes them.

Within each 10 dB attenuator step the maximum output setting of the channel at which clipping is avoided is reduced from the range maximum to half this value as the modulation is increased from 0 to 100 %. 100 % modulation will be achieved at this mid-range setting with an external VCA signal of approximately 1 V p-p. The frequency range for the modulating signal is DC to 100 kHz.

It is also possible to modulate a dc level from the generator with a signal applied to the **EXT MODULATION** socket, as follows:

Set the generator to external trigger on the TRIGGER IN set-up screen but do not apply a trigger signal to the TRIG IN socket; select square in the STANDARD WAVEFORMS screen. The MAIN OUT socket now provides a constant voltage which is the peak positive voltage defined by the current amplitude setting. Pressing the ± key with AMPLITUDE displayed will set the level to the peak negative voltage. This DC level can now be modulated by the signal applied to the **EXT MODULATION** input.

External SCM

Select SCM with the type soft-key on the MODULATION screen. Connect the modulating signal to the **EXT MODULATION** input (nominally 1 kΩ input impedance). With no signal the carrier is fully suppressed; a positive or negative level change at the modulation input increases the amplitude of the carrier. Note that clipping will occur if the SCM signal attempts to drive the output above the 20 V p-p open-circuit voltage limit.

Peak modulation, i.e. maximum carrier amplitude (20 V p-p), is achieved with an external SCM level of approximately ±1 V, i.e. a 2 V p-p signal. The modulation frequency range is DC to 100 kHz.

When external SCM is selected for a channel the amplitude control of that channel is disabled. The AMPLITUDE set-up screen shows the message fixed by SCM.

Internal Modulation

Only the multi-channel instruments (models 282 and 284) can make use of internal modulation; the single-channel model 281 has no internal modulation capability.

Pressing the **MODULATION** key calls the MODULATION set-up screen.

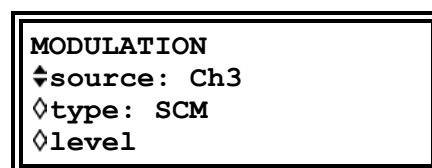

The `source` soft-key steps the modulation choice between `off`, `external` and `CHx` where `x` is the number of the previous channel.

With `CHx` selected the modulation can be switched between `AM` and `SCM` with alternate presses of the `type` soft-key.

When `AM` is selected the screen has an additional soft-key labeled `depth`; selecting this key permits the modulation depth to be set directly from the keyboard or by the rotary control.

Warnings are given when either a modulation depth or output amplitude change has caused clipping; the new setting is accepted but one of the two parameters must be changed to eliminate clipping.

When `SCM` is selected the screen has an additional soft-key labeled `level`; selecting this key permits the peak carrier output level to be set directly from the keyboard or by the rotary control. The maximum output level that can be set is 10 V p-p.

When internal `SCM` is selected for a channel both the amplitude control of that channel and of the previous channel (which is the modulation source) are disabled. The `AMPLITUDE` set-up screen of the channel being modulated shows the message `fixed by SCM`. The `AMPLITUDE` screen of the previous channel shows the message `Set by CHx mod.` and its status screen shows the message `➔x` to indicate that it is being used as a source for channel `x`.

Internal modulation can not be used with internal or external sum.

Chapter 12 **Sum**

Introduction.....	12-2
External Sum.....	12-2
Internal Sum.....	12-3

Introduction

Both internal and external sum can be selected; summing can be used to add noise to a waveform, for example, or to add two signals for DTMF (dual tone multiple frequency) testing.

External sum can be applied to any or all channels. Internal sum uses the previous channel as the source, so that for example channel 2 can be added into channel 3; internal sum is not available on channel 1 or on a single channel instrument.

Summing shares some of the generator's inter-channel resources with the modulation modes; as a result neither internal nor external sum can be used with internal modulation but external modulation is still possible with sum.

To better understand the constraints, the following sections (and chapter 11, *Modulation*) should be read with reference to the block diagrams in appendix F. These show the control signals in a single channel and the inter-channel connections.

These diagrams also show the inter-channel trigger connections described in chapter 7, *Triggered Burst and Gate*; in general, inter-channel triggering is possible simultaneously with summing.

External Sum

In sum mode an external signal applied to the **SUM** input is summed with the waveform(s) on the specified channel(s). The same sum input signal can be used at different amplitudes with each of the channels with which it is summed.

Pressing the **SUM** key calls the `SUM` set-up screen:

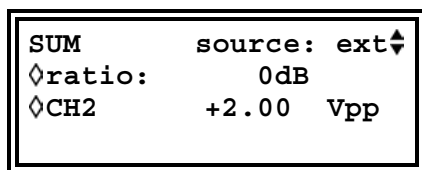

Pressing the `source` soft-key steps the sum sources between `off`, `external` and `CHx` where `x` is the number of the previous channel.

With `ext` selected the screen is as shown above. The level of the **SUM** can be adjusted independently for the selected channel by pressing the `ratio` soft-key; use the rotary knob or cursor keys to set the **SUM** input attenuation for that channel from 0 to -50 dB in 10 dB steps. This facility permits the same **SUM** signal to be used at different levels with each channel.

Clipping will occur if the sum input level attempts to drive the channel amplitude above the maximum 20 V p-p open-circuit voltage. However, the relationship between the **SUM** input and the maximum summed output depends not only on the sum input level but also on the channel's own amplitude setting. This is because the sum input is applied to the amplifier chain prior to the output attenuators. The amplifier itself is controlled over a limited range (approximately 10 dB) and the full amplitude range of the channel is achieved by switching in up to five 10 dB attenuation stages. The summed output cannot exceed the maximum of the range within which the channel output has been set by choice of amplitude setting. Whereas with internal sum the generator gives warnings when the combination of sum input and amplitude would cause waveform clipping (see *Internal Sum* below), it is the responsibility of the user to observe the waveforms when using external sum and to make adjustments if the waveform is clipped. Note that it is not

possible to give a simple guide as to where the range breakpoints are because the use of dc offset, for example, changes these points.

Within each range a **SUM** signal of approximately 2 V p-p will force the channel output from the range minimum to the range maximum; if the channel amplitude is set to mid-range then the **SUM** signal needed to force the output to range maximum is halved to approximately 1 V p-p.

To facilitate the setting of appropriate sum and amplitude levels the output amplitude of the selected channel can also be changed from the **SUM** set-up screen. Press the **CHx** soft-key and adjust the amplitude with direct keyboard entries or by using the rotary control.

External sum cannot be used with internal modulation.

Internal Sum

Only the multi-channel instruments (models 282 and 284) can make use of internal sum; the single-channel model 281 has no internal sum capability.

Pressing the **SUM** key calls the **SUM** set-up screen:

SUM	source: CH1 ↕
◇ratio:	1.00000
◇CH2	+2.00 Vpp
◇CH1	+2.00 Vpp

Pressing the **source** soft-key steps the sum source between **off**, **external** and **CHx** (where **x** is the number of the previous channel). **CHx** is the source of the internal sum signal.

With **CHx** selected for internal sum the screen is as shown above. The amplitude of both the summing channel, **CHx+1**, and the internal sum signal, **CHx**, are shown in the display, together with the **ratio** in which they are combined. All three parameters can be selected with the appropriate soft-key and set directly from the keyboard or by using the rotary control. Changing any one parameter will also adjust one of the other two; for example adjusting the amplitude of either channel will cause the displayed ratio to change.

The value shown in the **ratio** field is the **CHx** amplitude divided by the **CHx+1** amplitude. Adjusting the ratio value directly changes the amplitude of the sum input signal, **CHx**, not the channel's output amplitude. When a value is entered into the **ratio** field it is initially accepted as entered but may then change slightly to reflect the actual ratio achieved with the nearest sum input amplitude that could be set for the given channel output amplitude.

Warnings are given when either a ratio, sum input or output amplitude change is attempted which would cause the channel's output to be driven into clipping.

In general it is recommended that the amplitude of the sum input is smaller than the channel amplitude, i.e. the ratio is less than or equal to 1; ratio values can be set from very small signal levels up to unity. If the sum input is greater than the channel amplitude there will be combinations when the ratio can be set to a little greater than 1. Note that the software will always accept an entry, make the calculation and, if the combination is not possible, return the instrument to its last legitimate setting.

The amplitude of the channel being used for the internal sum signal can still be adjusted on its own **AMPLITUDE** set-up screen; its status screen shows the message **→x** to indicate that it is being used as a source for channel x.

Internal sum cannot be used with internal modulation.

Chapter 13

Synchronization

Introduction.....	13-2
Inter-Channel Synchronization	13-2
Synchronizing Principles.....	13-2
Master-Slave Allocation.....	13-2
Phase-setting between Channels.....	13-3
Other Phase-Locking Considerations	13-4
Synchronizing Two Generators	13-5
Synchronizing Principles.....	13-5
Connections for Synchronization	13-5
Generator Set-ups	13-5
Synchronizing	13-7

Introduction

Two or more channels in one multi-channel generator can be synchronized together and precise phase differences can be set between the channels. Two separate generators can also be synchronized, giving a maximum of 8 channels that can be operated synchronously.

Inter-Channel Synchronization

This section covers the use of a multi-channel instrument to produce two or more synchronous signals, and certain restrictions which apply to some specific waveform and frequency combinations.

Synchronizing Principles

Frequency locking is achieved by using the clock output from a master channel to drive the clock inputs of one or more slave channels. Any one channel can be the master and any or all the others can be slaves; master, slaves and independent channels can be mixed on the same instrument.

When frequency locking is switched on, an internal lock signal from the CPU locks the channels at the specified inter-channel phase and re-locks them automatically every time the frequency is changed. The clock and internal lock signals are shown in the *Inter-Channel Block Diagram* in appendix F. Channels to be locked together must all be operated in continuous mode.

For DDS-generated waveforms (refer to *Principles of Operation* in chapter 4) it is the 27.4878 MHz signal that is distributed from the master to the slaves, and channels can in principle be frequency-locked with any frequency combination. However, the number of cycles between the phase-referenced points will be excessively large unless the ratio is a small rational number; for example a 2 kHz signal could be locked usefully with 10 kHz, 50 kHz, 100 kHz, etc., but not with 2.001 kHz.

For clock synthesized waveforms it is the PLL clock of the master which is distributed from master to slaves; the clock frequency for master and slaves is therefore always the same. The number of points comprising the waveforms should also be the same to ensure that the waveforms themselves appear locked.

From the foregoing it is clear that only DDS slaves can be locked to a DDS master and only clock synthesized slaves can be locked to a clock synthesized master. In practice the constraints described are not severe as the most common use of synchronization is to provide outputs of the same waveform at the same frequency, or a harmonic of it, often with controlled phase offsets.

Master-Slave Allocation

Press the front panel **INTER CH**annel key to call up the inter-channel set-up screen.

```

mode: indep
phase: +000.0°
(actual: +000.0°)
status: off      view
  
```

The mode soft-key can be used to select between independent, master, master/freq and slave; the default mode is independent. Only one

`master` can be set. (More than one master can be selected but when locking is turned on with the `status` soft-key the set-up will be rejected.) `Master/freq` selects the master and sets frequency-tracking; for this to be operational the master and slave(s) must be set to the same frequency when locking is turned on. In this mode, when the frequency of the master is changed the frequency of the slaves also changes and the slaves are re-locked to the master.

`Master/freq` is the default mode when the waveforms are clock synthesized (arbs, pulses, etc); if `master` has been set instead the mode will automatically change to `master/freq` when locking is turned on. The frequency of clock synthesized waveform slaves always therefore tracks the master. Finally, `slave` selects those channel(s) which are to be locked to the master.

At any time, pressing the `view` soft-key gives a graphical view of the master-slave set-up, for example:

CH➔	1	2	3	4
indep	-	-	-	<input type="checkbox"/>
master	<input type="checkbox"/>	-	-	-
slave	-	<input type="checkbox"/>	<input type="checkbox"/>	- exit◊

Channel locking is turned on or off with the `status` soft-key. Any illegal setting combinations will result in an error message when an attempt is made to turn status on. Any of the following conditions will cause an error (see also *Synchronizing Principles* above for a discussion of the set-up constraints):

1. More than one master channel is enabled.
2. No master channel is enabled.
3. The locked channels contain a mixture of DDS and PLL generated waveforms.
4. Frequency tracking is enabled (mode: `master/freq`) but the frequencies are not the same on all channels. If PLL waveforms are locked the mode will be forced to frequency tracking.
5. A locked channel is not set to continuous mode.
6. An attempt is made to turn on phase lock with a frequency set too high. Note that the maximum frequency for phase-locked DDS operation is 10MHz.
7. An attempt is made to set the frequency too high during phase lock. This error does not set phase lock to off, the system simply inhibits the setting of the incorrect frequency.

In addition to the illegal setting combinations there are further considerations which affect the phase resolution and accuracy between channels; see below.

Phase-setting between Channels

The inter-channel set-up screen also has a field for setting up the phase of the slaves with respect to the master:

```

mode: indep
phase: +000.0°
(actual: +000.0°
status: off      view

```

Selecting the `phase` soft-key allows the phase to be set by direct keyboard entry or by rotary control. Setting the phase of a slave positive advances the waveform of the slave with respect to the master; setting it negative delays the slave with respect to the master.

The phase of each slave channel can be set independently. The phase of the master can also be set, although this function is intended primarily for use in phase-locking between two generators. If both the master and the slaves are set to $+90^\circ$, say, on the same generator then the waveforms will all be in phase again; if the master is set to $+90^\circ$ and the slaves set to -90° the master and slave waveforms will be 180° out of phase.

DDS-generated waveforms can be phase-locked with 0.1° resolution up to their maximum available frequency; sine, cosine, haversine and havercosine are limited to 10 MHz in phase-locked mode.

The phase-locking resolution of arbitrary waveforms will be less than 0.1° for waveforms of less than 3600 points. The phase is fixed at 0° for pulses, pulse-trains and sequences.

Below is a summary of the phase control and frequency range for different waveforms.

Waveform	Max waveform frequency	Phase control range, resolution
Sine, cosine, haversine, havercosine	10 MHz	$\pm 360^\circ$, 0.1°
Square	16 MHz	0° only
Triangle	100 kHz	$\pm 360^\circ$, 0.1°
Ramp	100 kHz	$\pm 360^\circ$, 0.1°
Sin(x)/x	100 kHz	$\pm 360^\circ$, 0.1°
Pulse & Pulse Train	10 MHz	$\pm 360^\circ$, $360^\circ \div \text{length}$ or 0.1°
Arbitrary	40 MS/s clock	$\pm 360^\circ$, $360^\circ \div \text{length}$ or 0.1°
Sequence	40 MS/s clock	0° only

When phase-locking is turned on with the status soft-key the slaves are re-locked automatically after every phase or frequency setting change.

Further considerations are listed below.

Other Phase-Locking Considerations

The *Master-Slave Allocation* and *Phase Setting between Channels* sections contain tables of specific limitations on the selection of frequency, waveform type and phase-setting range and resolution. The following four points should also be considered.

1. The waveform filters introduce a frequency-dependent delay above about 1 MHz; this will affect the accuracy of the phase between locked waveforms at different frequencies.
2. Square waves, which are 2-point clock synthesized waveforms, will not reliably lock to other clock synthesized waveforms.

3. Pulse and pulse train waveforms will lock to other pulse and pulse-trains (and to each other) but should be built with equal periods.
4. Arb waveforms should be the same length (although this requirement is not forced and violations do not create error messages).

Synchronizing Two Generators

This section covers the use of two generators to produce two or more synchronous signals. It is possible to link more than two generators in this way but the results are not guaranteed.

Synchronizing Principles

Frequency locking is achieved by using the clock output from the master generator to drive the clock inputs of a slave. The additional connection of an initializing **SYNC** signal permits the slave to be synchronized such that the phase relationship between master and slave outputs is that specified on the slave generator's inter-channel set-up screen.

Synchronization is only possible between generators when the ratio of the master and slave frequencies is rational, e.g. 3 kHz can be synchronized with 2 kHz but not with 7 kHz.

Special considerations arise with waveforms generated by clock synthesis mode (square wave, arbitrary, pulse, pulse-train and sequence) because of the relatively poor precision with which the frequency is actually derived in the hardware. With these waveforms, frequencies with an apparently rational relationship (e.g. 3:1) may be individually synthesized such that the ratio is not close enough to e.g. 3:1 to maintain phase lock over a period of time; the only relationships guaranteed to be realized precisely are $2^n:1$ because the division stages in clock synthesis mode are binary.

A further complication arises with arb waveforms because waveform frequency depends on both waveform size and clock frequency (waveform frequency = clock frequency divided by waveform size). The important relationship with arbs is the ratio of clock frequencies and the above considerations on precision apply to them. The most practical use of synchronization will be to provide outputs at the same frequency, or maybe harmonics, but with phase differences.

Connections for Synchronization

The clock connection arrangement is for the rear panel **REF CLOCK IN/OUT** of the master, which will be set to `phase lock master`, to be connected directly to the **REF CLOCK IN/OUT** socket of the slave, which will be set to `phase lock slave`.

Similarly the synchronizing connection is from any **SYNC OUT** of the master (which all default to `phase lock`) to the **TRIG IN** socket of the slave.

Generator Set-ups

Each generator can have its main parameters set to any values, with the exception that the ratio of frequencies between master and slave must obey the rules above; and each generator can be set to any waveform (but see the section on Synchronizing Principles above). Best results will be achieved if the constraints forced on inter-channel synchronization are adopted for inter-generator synchronization.

The master has its **CLOCK IN/OUT** set to `phase lock master` on the `REF. CLOCK I/O SETUP` menu called by the `ref. clock i/o` soft-key on the

UTILITY screen. Refer to chapter 14, *System Operations from the Utility Menu* for additional information.

```
REF  CLOCK I/O SETUP
◇input
◇output
▽phase lock slave
```

Repeated presses of the phase lock soft-key toggle between master and slave.

The slave is set to slave. Setting the slave generator to phase lock slave forces the slave's mode to continuous and defaults all the **SYNC OUT** outputs to phase lock. Only one of the **SYNC OUTs** is needed for inter-generator synchronization; the others may be reset to other functions if required. The phase relationship between the slave and the master is set on the inter-channel set-up screen of the slave, accessed by pressing the **INTER CH**annel key.

```
▽mode: indep
◇phase: +000.0°
      (actual: +000.0°
◇status: off      view◇
```

The phase of the slave generator is set by adjusting the phase of the master channel on the slave generator's inter-channel set-up screen exactly as described above for phase setting between the channels of a multi-channel instrument. The same section also covers the set-up for the phase(s) of the slave channel(s) on the slave generator.

When a single-channel generator (which has no inter-channel set-up key or screen) is the slave, its phase is set using the **TRIGGER/GATE SETUP** screen. The Trigger Phase section of the Triggered Burst and Gate chapter covers this process.

The convention adopted for the phase relationship between generators is the same as that used between channels, i.e. a positive phase setting advances the slave generator with respect to the master and a negative setting delays the slave generator. The status of the slave generator on the inter-channel set-up screen must be set to **on** (this is automatic on a single channel instrument).

Hardware delays become increasingly significant as frequency increases causing additional phase delay between the master and slaves. However, these delays can be largely nulled-out by backing off the phase settings of the slaves.

Typically these hardware delays are as follows:

DDS waveforms: <± 25 ns <1° to 100 kHz

Clock Synthesized waveforms: <300 ns <1° to 10 kHz.

Clearly a multi-channel generator gives much closer inter-channel phase-locking and is the recommended method for up to 4 channels.

Synchronizing

Having made the connections and set up the generators as described in the preceding paragraphs, synchronization is achieved by pressing the **MAN TRIG** key of the slave. Once synchronized any change to the set-up will require resynchronization with the **MAN TRIG** key again.

Chapter 14

System Operations from the Utility Menu

Introduction.....	14-2
Storing and Recalling Set-ups.....	14-2
Channel Waveform Information.....	14-2
Warnings and Error messages.....	14-3
Remote Interface Set-up	14-3
Reference Clock In/Out Setting	14-3
Cursor/Marker Output.....	14-3
Power On Setting	14-4
System Information.....	14-4
Calibration	14-5
Copying Channel Set-ups	14-5

Introduction

Pressing the **UTILITY** key calls a list of menus which give access to various system operations including storing and recalling set-ups from non-volatile memory, error messages, power-on settings and calibration.

Storing and Recalling Set-ups

Complete waveform set-ups can be stored to or recalled from non-volatile RAM using the menus called by the `store...` and `recall...` soft-keys.

Pressing the `store...` soft-key (or the **STORE** front panel key, in the case of multi-channel instruments) calls the store screen:

```
Save to store No: 1
◇execute
```

Nine stores are available, numbered 1 to 9 inclusive. Select the store using the rotary control or direct keyboard entry and press `execute` to implement the store function.

Pressing `recall...` (or the **RECALL** front panel key) calls the recall screen:

```
Recall store No: 1
◇set defaults
◇execute
```

In addition to the user-defined stores, the factory defaults can be reloaded by pressing the `set defaults` soft-key. Note that loading the defaults does not change any arbitrary waveforms, the set-ups stored in memories 1 to 9, or the RS232/GPIB interface settings.

Channel Waveform Information

Information about each channel's waveform memory can be viewed by pressing the `chan wfm info...` soft-key:

```
CHANNEL WFM INFO:
waveforms: 1
free mem: 65436
exit◇
```

For each channel selected (using the channel **SETUP** keys), the number of waveforms and the free memory on that channel are shown.

Warnings and Error messages

The default set-up is for all warning and error messages to be displayed and for a beep to sound with each message. This set-up can be changed on the `error...` menu:

```

◇error beep: ON
◇error message: ON
⚡warn beep: ON
◇warn message: ON
    
```

Each feature can be turned `ON` or `OFF` with alternate presses of the appropriate soft-key.

The last two error messages can be viewed by pressing the `last error...` soft-key. Each message has a number and the full list appears in appendix B. See also *Warnings and Error Messages* in chapter 5, *Standard Waveform Operation*.

Remote Interface Set-up

Pressing `remote...` calls the `REMOTE SETUP` screen which permits RS232 or GPIB choice and the selection of address and Baud rate. Full details are given in chapter 16, *Remote Operation*.

Reference Clock In/Out Setting

The function of the rear panel **REF CLOCK IN/OUT** socket is set on the `REF. CLOCK I/O` screen, called by pressing the `ref. clock i/o` soft-key:

```

REF. CLOCK I/O:
◆input
◇output
◇phase lock
    
```

The default setting is for the socket to be set to `input`, i.e. an input for an external 10 MHz reference clock. When set to `input` the system is automatically switched over to the external reference when an adequate signal level (TTL/CMOS threshold) is detected at the **REF CLOCK IN/OUT** socket but will continue to run from the internal clock in the absence of such a signal.

With the clock set to `output` a buffered version of the internal 10 MHz clock is made available at the socket.

With `phase lock` selected the socket can be set to be a `master` or a `slave` when used for synchronizing (phase-locking) multiple generators. Refer to chapter 13, *Synchronization* for full details.

Cursor/Marker Output

Pressing the `cursor/marker...` soft-key calls the `CURSOR/MARKER OUTPUT` screen:

```

CURSOR/MARKER OUTPUT
◆amplitude: 2V
◇polarity: negative
◇cursor width: 1

```

The cursor/marker signal is output from the rear panel **CURSOR/MARKER OUT** socket. It is used as a marker in sweep mode or as a cursor in arbitrary waveform mode. It can be used to modulate the Z-axis of an oscilloscope or be displayed on a second oscilloscope channel.

With `amplitude` selected the cursor/marker level can be set between 2 and 14 V in 2 V steps. With `polarity` selected the polarity can be set `positive` or `negative`. With `polarity` set to `positive` the cursor/marker is a positive-going pulse from the 0 V baseline; with `polarity` set to `negative` the cursor/marker is a negative-going pulse from the 2 to 14V set amplitude level; i.e. `negative` gives an inverted signal.

When used as a sweep marker (with sweep mode selected) the width is determined by the time spent at the marker frequency. See the section headed *Sweep Marker* in chapter 6, *Sweep* for full details.

When used as a cursor during arbitrary waveform editing (with `edit waveform` selected on the `MODIFY` screen) the width can be adjusted by repeated presses of the `cursor width` soft-key or by using the rotary control. The width is adjustable so that the cursor can still be made visible even with long arbitrary waveforms. The width is always an odd number of waveform points increasing in steps of 2 points (1, 3, 5, 7, etc.). A `width` setting of 1 corresponds to 1 waveform point, `width: 2` is 3 points, `width: 3` is 5 points and so on up to `width: 30` which is 59 points.

Power On Setting

Pressing the `power on...` soft-key calls the `POWER ON SETTING` screen:

```

POWER ON SETTING
◇default values
◇restore last setup
◆recall store no. 1

```

The setting loaded can be selected with the appropriate soft key to be `default values` (the default setting), `restore last setup` (i.e. the settings at power down are restored at power up) or any of the settings stored in non-volatile memories 1 to 9. `Default values` restores the factory default settings, described in the appendix.

System Information

The `system info...` soft-key calls the `SYSTEM INFO` screen which shows the instrument name and software revision. When `system info...` is pressed a checksum is also calculated on the firmware EPROM and the result displayed; this can be used when a software fault is suspected to check that the contents of the EPROM have not been corrupted.

Calibration

Pressing the `calibration` soft key calls the calibration routine, described in chapter 15, *Calibration*.

Copying Channel Set-ups

An easy way of copying complete channel set-ups (waveform, frequency, amplitude, etc.) is accessed by pressing the **COPY CHannel** key:

```
copy channel: 1
↕to channel: 2
◇execute
```

The first line of the screen shows which channel is currently selected with the channel **SETUP** keys. Pressing the `to channel:` soft-key steps the channel number through all the other channels of the instrument.

Select the channel to be changed and make the copy by pressing the `execute` soft-key.

Chapter 15

Calibration

- Introduction..... 15-2
- Equipment Required 15-2
- Calibration Procedure 15-2
 - Setting the Password..... 15-2
 - Password Access to Calibration 15-3
 - Changing the Password 15-3
- Calibration Routine..... 15-3
- Remote Calibration 15-5

Introduction

All parameters can be calibrated without opening the instrument case; the generator offers 'closed-box' calibration. All adjustments are made digitally with calibration constants stored in EEPROM. The calibration routine requires only a digital voltmeter (DVM) and a frequency counter and takes no more than a few minutes.

The crystal in the timebase is pre-aged but a further ageing of up to ± 5 ppm can occur in the first year. Since the ageing rate decreases exponentially with time it is an advantage to recalibrate after the first six month's use. Apart from this it is unlikely that any other parameters will need adjustment.

Calibration should be carried out only after the generator has been operating for at least 30 minutes in normal ambient conditions.

Equipment Required

1. 3½ digit DVM with 0.25% dc accuracy and 0.5% ac accuracy at 1 kHz.
2. Frequency counter capable of measuring 10.00000 MHz.

The DVM is connected to the **MAIN OUT** of each channel in turn and the counter to any **SYNC OUT**.

Frequency meter accuracy will determine the accuracy of the generator's clock setting and should ideally be ± 1 ppm.

Calibration Procedure

The calibration procedure is accessed by pressing the `calibration...` soft-key on the `UTILITY` screen.

```

CALIBRATION SELECTED
  Are you sure ?
◇password...      tests...◇
◇exit             continue◇
  
```

The software provides for a 4-digit password in the range 0000 to 9999. The password is used to protect against accidental or unauthorized access to the calibration procedure. If the password is left at the factory default of 0000 no messages are shown and calibration can proceed as described in the *Calibration Routine* section below; only if a non-zero password has been set will the user be prompted to enter the password.

Setting the Password

On opening the calibration screen press the `password...` soft-key to show the password screen:

```

ENTER NEW PASSWORD
  ----
  
```

Enter a 4-digit password from the keyboard; the display will show the message NEW PASSWORD STORED! for two seconds and then revert to the UTILITY menu. If any keys other than 0-9 are pressed while entering the password the message ILLEGAL PASSWORD! will be shown.

The password is held in EEPROM and will not be lost when the memory battery back-up is lost. In the event of the password being forgotten, contact the manufacturer for help in resetting the instrument.

Password Access to Calibration

With the password set, pressing calibration... on the UTILITY screen will now show:



When the correct password has been entered from the keyboard the display changes to the opening screen of the calibration routine and calibration can proceed as described below. If an incorrect password is entered the message INCORRECT PASSWORD! is shown for two seconds before the display reverts to the UTILITY menu.

Changing the Password

With the opening screen of the calibration routine displayed after correctly entering the password, the password can be changed by pressing the password... soft-key and following the procedure described above. If the password is set back to the factory default value 0000, password protection is removed.

Calibration Routine

The calibration procedure is entered by pressing continue on the opening calibration screen; pressing exit returns the display to the UTILITY menu.

Pressing tests... calls a menu of basic hardware checks used at production test; these are largely self-explanatory but details can be found in the *Service Manual* if required. At each step the display changes to prompt the user to adjust the rotary control or cursor keys, until the reading on the specified instrument is at the value given. The cursor keys provide coarse adjustment, and the rotary control fine adjustment.

Pressing next increments the procedure to the next step; pressing CE decrements back to the previous step. Alternatively, pressing exit returns the display to the last calibration screen at which the user can choose to either save new values, recall old values or calibrate again.

The first two displays (CAL 00 and CAL 01) specify the connections and adjustment method. The next display (CAL 02) allows the starting channel to be chosen; this allows quick access to any particular channel. To calibrate the complete instrument choose the default setting of CH1. The subsequent displays, CAL 03 to CAL 55, permit all adjustable parameters to be calibrated.

The full procedure is as follows:

CAL 03	CH1 DC offset zero	Adjust for 0 V \pm 5 mV
CAL 04	CH1 DC offset at + full scale	Adjust for +10 V \pm 10 mV
CAL 05	CH1 DC offset at - full scale	Check for -10 V \pm 3%
CAL 06	CH1 Multiplier zero	Adjust for minimum voltage (AC)
CAL 07	CH1 Multiplier offset	Adjust for 0 V \pm 5 mV
CAL 08	CH1 Waveform offset	Adjust for 0 V \pm 5 mV
CAL 09	CH1 Output level at full-scale	Adjust for 10 V \pm 10 mV
CAL 10	CH1 20 dB attenuator	Adjust for 1 V \pm 1 mV
CAL 11	CH1 40 dB attenuator	Adjust for 0.1 V \pm 1 mV
CAL 12	CH1 10 dB attenuator	Adjust for 2.236 V AC \pm 10 mV
CAL 13	CH1 Not used	
CAL 14	CH1 Not used	
CAL 15	CH1 Not used	
CAL 16	CH2 DC offset zero	Adjust for 0 V \pm 5 mV
CAL 17	CH2 DC offset at + full-scale.	Adjust for +10 V \pm 10 mV
CAL 18	CH2 DC offset at - full-scale	Check for -10 V \pm 3%
CAL 19	CH2 Multiplier zero	Adjust for minimum voltage (AC)
CAL 20	CH2 Multiplier offset	Adjust for 0 V \pm 5 mV
CAL 21	CH2 Waveform offset	Adjust for 0 V \pm 5 mV
CAL 22	CH2 Output level at full-scale	Adjust for 10 V \pm 10 mV
CAL 23	CH2 20 dB attenuator	Adjust for 1 V \pm 1 mV
CAL 24	CH2 40 dB attenuator	Adjust for 0.1 V \pm 1 mV
CAL 25	CH2 10 dB attenuator	Adjust for 2.236 V AC \pm 10 mV
CAL 26	CH2 Sum offset	Adjust for 0 V \pm 5 mV
CAL 27	CH2 SCM level at full-scale	Adjust for 5 V \pm 5 mV
CAL 28	CH2 AM level at full-scale	Adjust for 10 V \pm 10 mV
CAL 29	CH3 DC offset zero	Adjust for 0 V \pm 5 mV
CAL 30	CH3 DC offset at + full scale	Adjust for +10 V \pm 10 mV
CAL 31	CH3 DC offset at - full scale	Check for -10 V \pm 3%
CAL 32	CH3 Multiplier zero	Adjust for minimum voltage (AC)
CAL 33	CH3 Multiplier offset	Adjust for 0 V \pm 5 mV
CAL 34	CH3 Waveform offset	Adjust for 0 V \pm 5 mV
CAL 35	CH3 Output level at full-scale	Adjust for 10 V \pm 10 mV
CAL 36	CH3 20dB attenuator	Adjust for 1 V \pm 1 mV
CAL 37	CH3 40dB attenuator	Adjust for 0.1 V \pm 1 mV
CAL 38	CH3 10dB attenuator	Adjust for 2.236 V AC \pm 10 mV
CAL 39	CH3 Sum offset	Adjust for 0 V \pm 5 mV
CAL 40	CH3 SCM level at full-scale	Adjust for 5 V \pm 5 mV
CAL 41	CH3 AM level at full-scale	Adjust for 10 V \pm 10 mV
CAL 42	CH4 DC offset zero	Adjust for 0 V \pm 5 mV
CAL 43	CH4 DC offset at + full scale	Adjust for +10 V \pm 10 mV
CAL 44	CH4 DC offset at - full scale	Check for -10 V \pm 3%
CAL 45	CH4 Multiplier zero	Adjust for minimum voltage (AC)
CAL 46	CH4 Multiplier offset	Adjust for 0 V \pm 5 mV
CAL 47	CH4 Waveform offset	Adjust for 0 V \pm 5 mV
CAL 48	CH4 Output level at full-scale	Adjust for 10 V \pm 10 mV
CAL 49	CH4 20dB attenuator	Adjust for 1 V \pm 1 mV
CAL 50	CH4 40dB attenuator	Adjust for 0.1 V \pm 1 mV
CAL 51	CH4 10dB attenuator	Adjust for 2.236 V AC \pm 10 mV

CAL 52	CH4 Sum offset	Adjust for 0 V \pm 5 mV
CAL 53	CH4 SCM level at full-scale	Adjust for 5 V \pm 5 mV
CAL 54	CH4 AM level at full-scale	Adjust for 10 V \pm 10 mV
CAL 55	Clock calibrate	Adjust for 10-00000 MHz at SYNC OUT .

Remote Calibration

Calibration of the instrument may be performed over the RS232 or GPIB interface. To completely automate the process the DVM and frequency meter will also need to be remotely controlled and the controller will need to run a calibration program specific to this instrument.

The remote calibration commands allow a simplified version of manual calibration to be performed by issuing commands from the controller. The controller must send the CALADJ command repeatedly and read the DVM or frequency meter until the required result for the selected calibration step is achieved. The CALSTEP command is then issued to accept the new value and move to the next step.

While in remote calibration mode very little error checking is performed and it is the controller's responsibility to ensure that everything progresses correctly. Only the following commands should be used during calibration.

Important note

Using any other commands while in calibration mode may give unpredictable results and could cause the instrument to lock up, requiring the power to be cycled to regain control.

CALIBRATION <cpd> [,nrf]	The calibration control command. <cpd> can be one of three sub-commands:
START	Enter calibration mode; this command must be issued before any other calibration commands will be recognized.
SAVE	Finish calibration, save the new values and exit calibration mode.
ABORT	Finish calibration, do not save the new values and exit calibration mode.
	<nrf> represents the calibration password. The password is only required with CALIBRATION START and then only if a non-zero password has been set from the instrument's keyboard. The password will be ignored, and will give no errors, at all other times. It is not possible to set or change the password using remote commands.
CALADJ <nrf>	Adjust the selected calibration value by <nrf>. The value must be in the range -100 to +100. Once an adjustment has been completed and the new value is as required the CALSTEP command must be issued for the new value to be accepted.
CALSTEP	Step to the next calibration point.

For general information on remote operation and remote command formats, refer to chapter 16, *Remote Operation*.

Chapter 16

Remote Operation

Introduction.....	16-2
Address and Baud Rate Selection.....	16-2
Remote/Local Operation.....	16-2
RS232 Interface.....	16-3
RS232 Interface Connector.....	16-3
Single Instrument RS232 Connections.....	16-3
Addressable RS232 Connections.....	16-3
RS232 Character Set.....	16-4
Addressable RS232 Interface Control Codes.....	16-4
Full List of Addressable RS232 Interface Control Codes.....	16-6
GPIB Interface.....	16-6
GPIB Subsets.....	16-6
GPIB IEEE Std. 488.2 Error Handling.....	16-6
GPIB Parallel Poll.....	16-7
Status Reporting.....	16-7
Standard Event Status and Standard Event Status Enable Registers.....	16-7
Status Byte Register and Service Request Enable Register.....	16-8
Power on Settings.....	16-9
Remote Commands.....	16-10
RS232 Remote Command Formats.....	16-10
GPIB Remote Command Formats.....	16-10
Command List.....	16-11
Channel Selection.....	16-11
Frequency and Period.....	16-12
Amplitude and DC Offset.....	16-12
Waveform Selection.....	16-12
Arbitrary Waveform Create and Delete.....	16-13
Arbitrary Waveform Editing.....	16-14
Waveform Sequence Control.....	16-17
Mode Commands.....	16-17
Input/Output control.....	16-18
Modulation Commands.....	16-19
Phase Locking Commands.....	16-19
Status Commands.....	16-19
Miscellaneous Commands.....	16-21
Remote Command Summary.....	16-22

Introduction

The instrument can be remotely controlled via its RS232 or GPIB interfaces. When using RS232 it can either be the only instrument connected to the controller or it can be part of an addressable RS232 system which permits up to 32 instruments to be addressed from one RS232 port.

Some of the following sections are general and apply to all 3 modes (single instrument RS232, addressable RS232 and GPIB); others are clearly only relevant to a particular interface or mode. It is only necessary to read the general sections plus those specific to the intended remote control mode.

Address and Baud Rate Selection

For successful operation, each instrument connected to the GPIB or addressable RS232 system must be assigned a unique address and, in the case of addressable RS232, all must be set to the same Baud rate.

The instrument's remote address for operation on both the RS232 and GPIB interfaces is set via the `remote` menu on the **UTILITY** screen.

```

REMOTE :
↑interface: RS232
◇address:   05
◇baud rate: 9600
  
```

With `interface` selected with the `interface` soft-key, the selection can be toggled between RS232 and GPIB with alternate presses of the soft-key, the cursor keys or by using the rotary control.

With `address` selected, the soft-key, cursor keys or rotary control can be used to set the address.

With `baud rate` selected, the soft-key, cursor keys or rotary control can be used to set the baud rate for the RS232 interface.

When operating on the GPIB all device operations are performed through a single primary address; no secondary addressing is used. Note also that GPIB address 31 is not allowed by the IEEE 488 standards but it is possible to select it as an RS232 address.

Remote/Local Operation

At power-on the instrument will be in the local state with the **REMOTE** lamp off. In this state all keyboard operations are possible. When the instrument is addressed to listen and a command is received the remote state will be entered and the **REMOTE** lamp will illuminate. In this state the keyboard is locked out and remote commands only will be processed. The instrument may be returned to the local state by pressing the **LOCAL** key; however, the effect of this action will remain only until the instrument is addressed again or receives another character from the interface, when the remote state will once again be entered.

RS232 Interface

RS232 Interface Connector

The 9-way D-type serial interface connector is located on the instrument rear panel. The pin connections are as shown in chapter 3, *Connections*, table 3-1.

Single Instrument RS232 Connections

For single instrument remote control only pins 2, 3 and 5 are connected to the PC. However, for correct operation links must be made in the connector at the PC end between pins 1, 4 and 6 and between pins 7 and 8, as shown below. Pins 7 and 8 of the instrument must not be connected to the PC. This means you should not use a fully wired 9-way cable.

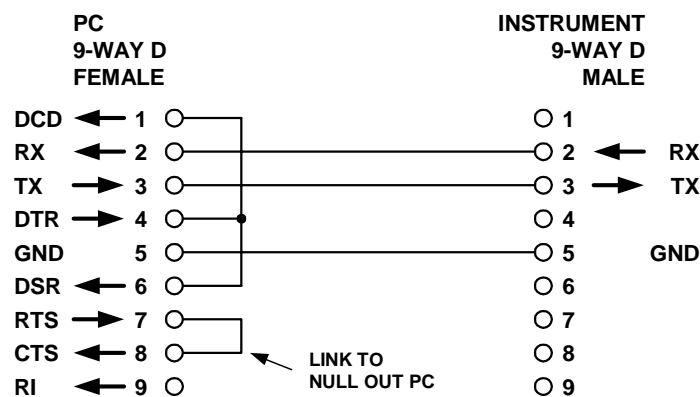

Figure 16-1. Single Instrument RS232 Connections

shb0009f.emf

Baud Rate is set as described above; the other parameters are fixed as follows:

Start Bits: 1
Data Bits: 8
Parity: None
Stop Bits: 1

Addressable RS232 Connections

For addressable RS232 operation pins 7, 8 and 9 of the instrument connector are also used.

Using a simple cable assembly you can make a 'daisy chain' connection system between any number of instruments up to the maximum of 32, as shown below:

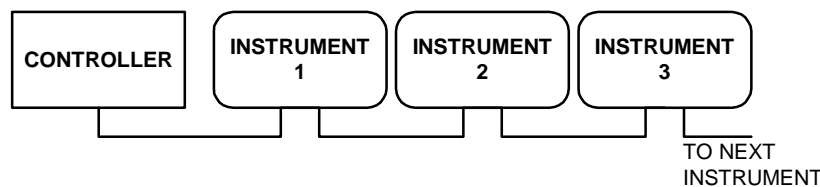

Figure 16-2. RS232 Daisy-Chain Instruments

shb0010f.emf

The daisy chain consists of the transmit data (TXD), receive date (RXD) and signal ground lines only. There are no control/handshake lines. This makes XON/XOFF protocol essential and allows the inter-connection between instruments to contain just 3 wires. The wiring of the adaptor cable is shown below:

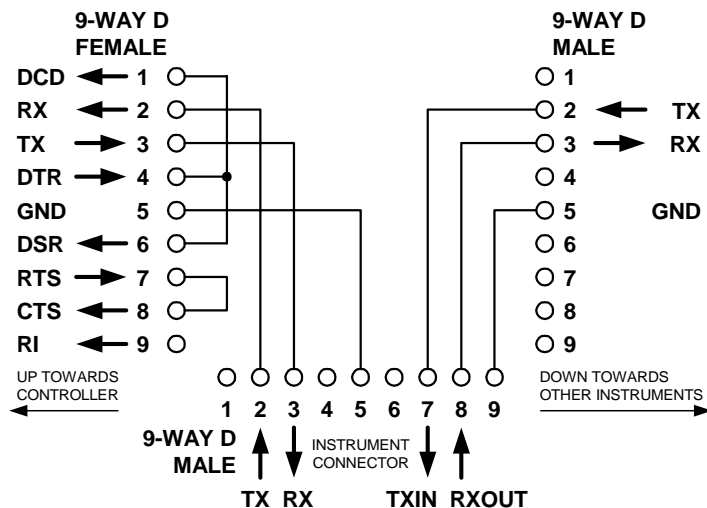

Figure 16-3. RS232 Daisy-Chain Connector Wiring

shb0011f.emf

All instruments on the interface must be set to the same baud rate and all must be powered on, otherwise instruments further down the daisy chain will not receive any data or commands.

The other parameters are fixed as follows:

- Start Bits: 1
- Data Bits: 8
- Parity: None
- Stop Bits: 1

RS232 Character Set

Because of the need for XON/XOFF handshaking it is only possible to send ASCII coded data; binary blocks are not allowed. Bit 7 of ASCII codes is ignored, i.e. assumed to be low. No distinction is made between upper and lower case characters in command mnemonics and they may be freely mixed. The ASCII codes below 20H (space) are reserved for addressable RS232 interface control. (In this manual 20H means 20 in hexadecimal.)

Addressable RS232 Interface Control Codes

All instruments intended for use on the addressable RS232 bus use the following set of interface control codes. Codes between 00H and 1FH which are not listed here as having a particular meaning are reserved for future use and will be ignored. Mixing interface control codes inside instrument commands is not allowed except as stated below for CR and LF codes and for XON and XOFF codes.

When an instrument is first powered on it will automatically enter the non-addressable mode. In this mode the instrument will not respond to any address commands. This allows the instrument to function as a normal RS232 controllable device. The non-addressable mode may be locked by sending the Lock Non-Addressable mode control code, 04H. The controller and instrument can now freely use all 8 bit codes and binary

blocks but all interface control codes are ignored. To return to addressable mode the instrument must be powered off.

To enable addressable mode after an instrument has been powered on the Set Addressable Mode control code, 02H, must be sent. This will then enable all instruments connected to the addressable RS232 bus to respond to all interface control codes. To return to non-addressable mode the Lock Non-Addressable mode control code must be sent which will disable addressable mode until the instruments are powered off.

Before you can send a command to an instrument it must be addressed to listen by sending the Listen Address control code, 12H, followed by a single character which has the lower 5 bits corresponding to the unique address of the required instrument. Thus the codes A-Z (or a-z) give the addresses 1-26 inclusive while @ is address 0 and so on. Once addressed to listen the addressed instrument will read and act upon any commands sent until the listen mode is cancelled.

Because of the asynchronous nature of the interface it is necessary for the controller to be informed that an instrument has accepted the listen address sequence and is ready to receive commands. The controller will therefore wait for the addressed instrument to provide the Acknowledge code, 06H, before sending any commands. The controller should time-out and try again if no Acknowledge is received within 5 seconds.

Listen mode will be cancelled on receipt of any of the following interface control codes:

- 12H Listen Address followed by an address not belonging to this instrument.
- 14H Talk Address for any instrument.
- 03H Universal Unaddress control code.
- 04H Lock Non-Addressable mode control code.
- 18H Universal Device Clear.

Before a response can be read from an instrument it must be addressed to talk by sending the Talk Address control code, 14H, followed by a single character which has the lower 5 bits corresponding to the unique address of the required instrument, as for the listen address control code above. Once addressed to talk the instrument will send the response message it has available, if any, and then exit the talk addressed state. Only one response message will be sent each time the instrument is addressed to talk.

Talk mode will be cancelled by any of the following interface control codes being received:

- 12H Listen Address for any instrument.
- 14H Talk Address followed by an address not belonging to this instrument.
- 03H Universal Unaddress control code.
- 04H Lock Non-Addressable mode control code.
- 18H Universal Device Clear.

Talk mode will also be cancelled when the instrument has completed sending a response message or has nothing to say.

The interface code 0AH (LF) is the universal command and response terminator; it must be the last code sent in all commands and will be the last code sent in all responses.

The interface code 0DH (CR) may be used as required to aid the formatting of commands; it will be ignored by all instruments. Most instruments will terminate responses with CR followed by LF.

The interface code 13H (XOFF) may be sent at any time by a listener (instrument or controller) to suspend the output of a talker. The listener must send 11H (XON) before the talker will resume sending. This is the only form of handshake control supported by the addressable RS232 mode.

Full List of Addressable RS232 Interface Control Codes

02H	Set Addressable Mode.
03H	Universal Unaddress control code.
04H	Lock Non-Addressable mode control code.
06H	Acknowledge that listen address received.
0AH	Line Feed (LF); used as the universal command and response terminator.
0DH	Carriage Return (CR); formatting code, otherwise ignored.
11H	Restart transmission (XON).
12H	Listen Address - must be followed by an address belonging to the required instrument.
13H	Stop transmission (XOFF).
14H	Talk Address - must be followed by an address belonging to the required instrument.
18H	Universal Device Clear.

GPIB Interface

The 24-way GPIB connector is located on the instrument rear panel. The pin connections are as specified in IEEE Std. 488.1-1987 and the instrument complies with IEEE Std. 488.1-1987 and IEEE Std. 488.2-1987.

GPIB Subsets

This instrument contains the following IEEE 488.1 subsets:

Source Handshake	SH1
Acceptor Handshake	AH1
Talker	T6
Listener	L4
Service Request	SR1
Remote Local	RL1
Parallel Poll	PP1
Device Clear	DC1
Device Trigger	DT1
Controller	C0
Electrical Interface	E2

GPIB IEEE Std. 488.2 Error Handling

The IEEE 488.2 `UNTERMINATED` error (addressed to talk with nothing to say) is handled as follows. If the instrument is addressed to talk and the response formatter is inactive and the input queue is empty then the `UNTERMINATED` error is generated. This will cause the Query Error bit to be set in the Standard Event Status Register, a value of 3 to be placed in the Query Error Register and the parser to be reset.

The IEEE 488.2 `INTERRUPTED` error is handled as follows. If the response formatter is waiting to send a response message and a `<PROGRAM MESSAGE TERMINATOR>` has been read by the parser or the input queue contains more than one `END` message then the instrument has been `INTERRUPTED` and an error is generated. This will cause the Query Error bit to be set in the Standard Event Status Register, a value of 1 to be placed in the Query Error Register and the response formatter to be reset thus clearing the output queue. The parser will then start parsing the next `<PROGRAM MESSAGE UNIT>` from the input queue.

The IEEE 488.2 `DEADLOCK` error is handled as follows. If the response formatter is waiting to send a response message and the input queue becomes full then the instrument enters the `DEADLOCK` state and an error is generated. This will cause the Query Error

bit to be set in the Standard Event Status Register, a value of 2 to be placed in the Query Error Register and the response formatter to be reset thus clearing the output queue. The parser will then start parsing the next <PROGRAM MESSAGE UNIT> from the input queue.

The section below on Status Reporting provides further information on these three error handling processes.

GPIB Parallel Poll

Complete parallel poll capabilities are offered on this generator. The Parallel Poll Enable Register is set to specify which bits in the Status Byte Register are to be used to form the `ist` local message. The Parallel Poll Enable Register is set by the `*PRE <nrf>` command and read by the `*PRE?` command. The value in the Parallel Poll Enable Register is ANDed with the Status Byte Register; if the result is zero then the value of `ist` is 0; otherwise the value of `ist` is 1.

The instrument must also be configured so that the value of `ist` can be returned to the controller during a parallel poll operation. The instrument is configured by the controller sending a Parallel Poll Configure command (PPC) followed by a Parallel Poll Enable command (PPE). The bits in the PPE command are as follows:

bit 7 =	x	don't care
bit 6 =	1	parallel poll enable
bit 5 =	1	
bit 4 =	0	
bit 3 =	sense	sense of the response bit; 0 = low, 1 = high
bit 2 =	?	bit position of the response
bit 1 =	?	
bit 0 =	?	

For example: to return the RQS bit (bit 6 of the Status Byte Register) as a 1 when true and a 0 when false in bit position 1 in response to a parallel poll operation, send the following commands

`*PRE 64<pmt>`, then `PPC` followed by `69H (PPE)`

The parallel poll response from the generator will then be 00H if RQS is 0 and 01H if RQS is 1.

During parallel poll response the DIO interface lines are resistively terminated (passive termination). This allows multiple devices to share the same response bit position in either wired-AND or wired-OR configuration, see IEEE 488.1 for more information.

Status Reporting

This section describes the complete status model of the instrument. Note that some registers are specific to the GPIB section of the instrument and are of limited use in an RS232 environment.

Standard Event Status and Standard Event Status Enable Registers

These two registers are implemented as required by the IEEE std. 488.2.

Any bits set in the Standard Event Status Register which correspond to bits set in the Standard Event Status Enable Register will cause the ESB bit to be set in the Status Byte Register.

The Standard Event Status Register is read and cleared by the `*ESR?` command. The Standard Event Status Enable register is set by the `*ESE <nrf>` command and read by the `*ESE?` command.

Bit 7	Power On. Set when power is first applied to the instrument.
Bit 6	Not used.
Bit 5	Command Error. Set when a syntax type error is detected in a command from the bus. The parser is reset and parsing continues at the next byte in the input stream.
Bit 4	Execution Error. Set when an error is encountered while attempting to execute a completely parsed command. The appropriate error number will be reported in the Execution Error Register.
Bit 3	Not used.
Bit 2	Query Error. Set when a query error occurs. The appropriate error number will be reported in the Query Error Register as listed below. <ol style="list-style-type: none"> 1. Interrupted error 2. Deadlock error 3. Unterminated error
Bit 1	Not used.
Bit 0	Operation Complete. Set in response to the <code>*OPC</code> command.

Status Byte Register and Service Request Enable Register

These two registers are implemented as required by the IEEE std. 488.2.

Any bits set in the Status Byte Register which correspond to bits set in the Service Request Enable Register will cause the `RQS/MSS` bit to be set in the Status Byte Register, thus generating a Service Request on the bus.

The Status Byte Register is read either by the `*STB?` command, which will return `MSS` in bit 6, or by a Serial Poll which will return `RQS` in bit 6. The Service Request Enable register is set by the `*SRE <nrf>` command and read by the `*SRE?` command.

Bit 7	Not used.
Bit 6	<code>RQS/MSS</code> . This bit, as defined by IEEE Std. 488.2, contains both the Requesting Service message and the Master Status Summary message. <code>RQS</code> is returned in response to a Serial Poll and <code>MSS</code> is returned in response to the <code>*STB?</code> command.
Bit 5	<code>ESB</code> . The Event Status Bit. This bit is set if any bits set in the Standard Event Status Register correspond to bits set in the Standard Event Status Enable Register.
Bit 4	<code>MAV</code> . The Message Available Bit. This will be set when the instrument has a response message formatted and ready to send to the controller. The bit will be cleared after the Response Message Terminator has been sent.
Bit 3	Not used.
Bit 2	Not used.
Bit 1	Not used.
Bit 0	Not used.

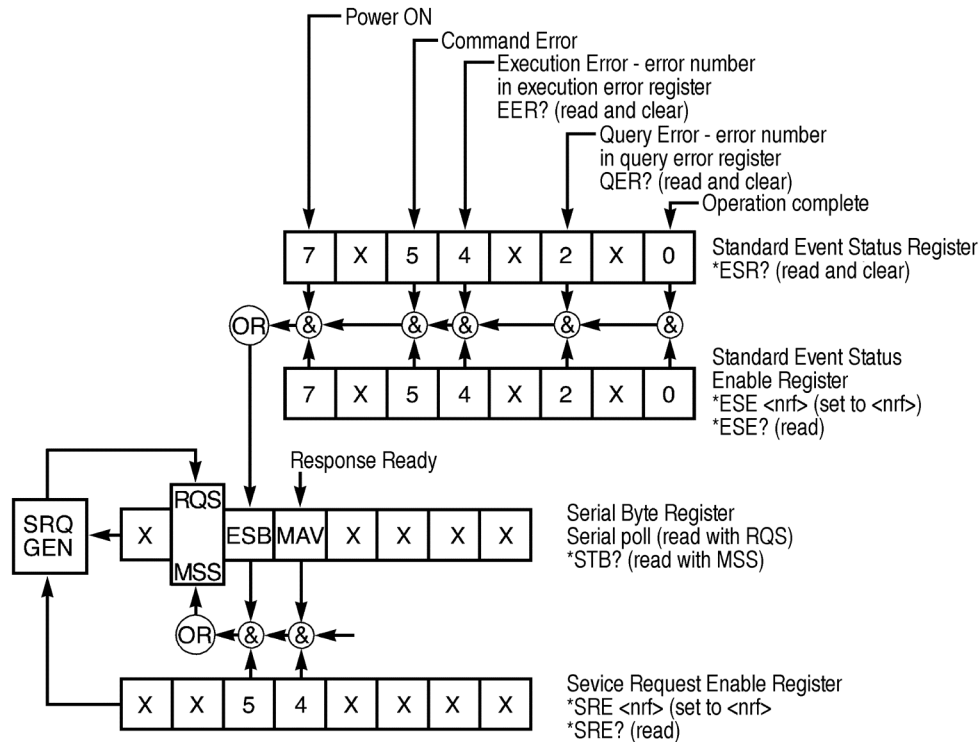

Figure 16-4. Status Model

shb0012f.gif

Power on Settings

The following instrument status values are set at power on:

Status Byte Register	= 0
Service Request Enable Register †	= 0
Standard Event Status Register	= 128 (pon bit set)
Standard Event Status Enable Register †	= 0
Execution Error Register	= 0
Query Error Register	= 0
Parallel Poll Enable Register †	= 0

† Registers marked thus are specific to the GPIB section of the instrument and are of limited use in an RS232 environment.

The instrument will be in local state with the keyboard active.

The instrument parameters at power on are determined on the POWER ON SETTING screen accessed from the UTILITY menu. If restore last setup or recall store no. nn has been set and a defined state is required by the controller at start up then the command *RST should be used to load the system defaults.

If for any reason an error is detected at power up in the non-volatile ram a warning will be issued and all settings will be returned to their default states as for a *RST command.

Remote Commands

RS232 Remote Command Formats

Serial input to the instrument is buffered in a 256 byte input queue which is filled, under interrupt, in a manner transparent to all other instrument operations. The instrument will send XOFF when approximately 200 characters are in the queue. XON will be sent when approximately 100 free spaces become available in the queue after XOFF was sent. This queue contains raw (un-parsed) data which is parsed as it is required. Commands and queries are executed in order and the parser will not start a new command until any previous command or query is complete.

In non-addressable RS232 mode responses to commands or queries are sent immediately; there is no output queue. In addressable mode the response formatter will wait, indefinitely if necessary, until the instrument is addressed to talk and the complete response message has been sent, before allowing the parser to start the next command in the input queue.

Commands must be sent as specified in the commands list and must be terminated with the command terminator code 0AH (line feed, LF). Commands may be sent in groups with individual commands separated from each other by the code 3BH (semicolon). The group must be terminated with command terminator 0AH (line feed, LF).

Responses from the instrument to the controller are sent as specified in the commands list. Each response is terminated by 0DH (carriage return, CR) followed by 0AH (line feed, LF).

<WHITE SPACE> is defined as character codes 00H to 20H inclusive with the exception of those which are specified as addressable RS232 control codes.

<WHITE SPACE> is ignored except in command identifiers (thus, for example, *C LS is not equivalent to *CLS).

The high bit of all characters is ignored.

The commands are not case-sensitive.

GPIB Remote Command Formats

GPIB input to the instrument is buffered in a 256 byte input queue which is filled, under interrupt, in a manner transparent to all other instrument operations. The queue contains raw (un-parsed) data which is taken by the parser as required. Commands (and queries) are executed in order and the parser will not start a new command until any previous command or query is complete. There is no output queue which means that the response formatter will wait, indefinitely if necessary, until the instrument is addressed to talk and the complete response message has been sent before the parser is allowed to start the next command in the input queue.

Commands are sent as <PROGRAM MESSAGES> by the controller, each message consisting of zero or more <PROGRAM MESSAGE UNIT> elements separated by <PROGRAM MESSAGE UNIT SEPARATOR> elements.

A <PROGRAM MESSAGE UNIT> is any of the commands in the remote commands list.

A <PROGRAM MESSAGE UNIT SEPARATOR> is the semi-colon character ';' (3BH).

<PROGRAM MESSAGES> are separated by <PROGRAM MESSAGE TERMINATOR> elements which may be any of the following:

- NL The new line character (0AH)
- NL^END The new line character with the END message
- ^END The END message with the last character of the message

Responses from the instrument to the controller are sent as <RESPONSE MESSAGES>. A <RESPONSE MESSAGE> consists of one <RESPONSE MESSAGE UNIT> followed by a <RESPONSE MESSAGE TERMINATOR>.

A <RESPONSE MESSAGE TERMINATOR> is the new line character with the END message NL^END.

Each query produces a specific <RESPONSE MESSAGE> which is listed along with the command in the remote commands list.

<WHITE SPACE> is ignored except in command identifiers (thus, for example, *C L S is not equivalent to *CLS).

<WHITE SPACE> is defined as character codes 00H to 20H inclusive with the exception of the NL character (0AH).

The high bit of all characters is ignored.

The commands are not case-sensitive.

Command List

This section lists all commands and queries implemented in this instrument. The commands are listed in alphabetical order within the function groups.

Note that there are no dependent parameters, coupled parameters, overlapping commands, expression program data elements or compound command program headers; each command is completely executed before the next command is started. All commands are sequential and the operation complete message is generated immediately after execution in all cases.

The following nomenclature is used:

- <rmt> <RESPONSE MESSAGE TERMINATOR>
- <cpd> <CHARACTER PROGRAM DATA>: a short mnemonic or string such as ON or OFF.
- <nrf> A number in any format. For example, 12, 12.00, 1.2e1 and 120e-1 are all accepted as the number 12. Any number, when received, is converted to the required precision consistent with the use, then rounded up to obtain the value of the command.
- <nrl> A number with no fractional part, i.e. an integer.
- [...] Any item(s) enclosed in these square brackets are optional parameters. If they enclose more than one item then all or none of the items are required.

The commands which begin with an asterisk (*) are those specified by IEEE Std. 488.2 as Common Commands. All will function when used on the RS232 interface but some have little applicability here.

Channel Selection

Most commands act on a particular channel of the generator. The following command is used to select the required channel. Subsequent commands will change only the specified parameter on the selected channel.

SETUPCH <nrf> Select channel <nrf> as the destination for subsequent commands. The value of <nrf> ranges from 1 to the highest channel number in the instrument.

Frequency and Period

These commands set the frequency or period of the generator main output and are equivalent to pressing the **FREQ** key and editing that screen.

WAVFREQ <nrf> Set the waveform frequency to <nrf> Hz.

WAVPER <nrf> Set the waveform period to <nrf> sec.

CLKFREQ <nrf> Set the arbitrary sample clock freq to <nrf> Hz.

CLKPER <nrf> Set the arbitrary sample clock period to <nrf> sec.

Amplitude and DC Offset

AMPL <nrf> Set the amplitude to <nrf> in the units as specified by the AMPUNIT command.

AMPUNIT <cpd> Set the amplitude units to <VPP>, <VRMS> or <DBM>.

ZLOAD <cpd> Set the output load, which the generator is to assume for amplitude and dc offset entries, to <50> (50 Ω), <600> (600 Ω) or <OPEN>.

DCOFFS <nrf> Set the dc offset to <nrf> Volts.

Waveform Selection

WAVE <cpd> Select the output waveform as <SINE>, <SQUARE>, <TRIANG>, <DC>, <POSRMP>, <NEGRMP>, <COSINE>, <HVSIN>, <HVCOS>, <SINC>, <PULSE>, <PULSTRN>, <ARB> or <SEQ>.

PULSPER <nrf> Set the pulse period to <nrf> sec.

PULSWID <nrf> Set the pulse width to <nrf> sec.

PULSDLY <nrf> Set the pulse delay to <nrf> sec.

PULTRNLEN <nrf> Set the number of pulses in the pulse-train to <nrf>.

PULTRNPER <nrf> Set the pulse-train period to <nrf> sec.

PULTRNBASE <nrf> Set the pulse-train base line to <nrf> Volts.

PULTRNLEV <nrf1>,<nrf2> Set the level of pulse-train pulse number <nrf1> to <nrf2> Volts.

PULTRNWID <nrf1>, <nrf2>	Set the width of pulse-train pulse number <nrf1> to <nrf2> sec.
PULTRNDLY <nrf1>, <nrf2>	Set the delay of pulse-train pulse number <nrf1> to <nrf2> sec.
PULTRNMAKE	Make the pulse-train and run it - similar to the WAVE PULSTRN command.
ARB <cpd>	Select an arbitrary waveform for output. <cpd> must be the name of an existing arbitrary waveform. Backup memory is always used as the source of the arb. The arb will be copied to the channel memory if necessary.
ARBLISTCH?	Returns a list of all arbitrary waveforms in the channel's memory. Each will return a name and length in the following form <cpd>, <nr1>. The list will end with <rmt>.
ARBLIST?	Returns a list of all arbitrary waveforms in backup memory. Each will return a name and length in the following form <cpd>, <nr1>. The list will end with <rmt>.

Arbitrary Waveform Create and Delete

Care should be take to ensure that all channels in the instrument are running in CONTINUOUS mode before using commands from this section. Failure to observe this restriction may give unexpected results.

ARBDELETE <cpd>	Delete the arbitrary waveform <cpd> from backup memory.
ARBCLR <cpd>	Delete the arb <cpd> from channel memory. The backup memory is not changed.
ARBCREATE <cpd>, <nrf>	Create a new, blank arbitrary waveform with name <cpd> and length <nrf> points.
ARBDEFCSV <cpd>, <nrf>, <csv ascii data>	Define a new or existing arbitrary waveform with name <cpd> and length <nrf> and load with the data in <csv ascii data>.
	If the arbitrary waveform does not exist it will be created. If it does exist the length will be checked against that specified and a warning will be issued if they are different.
	The edit limits will be set to the extremes of the waveform.
	The data consists of ascii coded values, in the range -2048 to +2047, for each point. The values are separated by a comma

```
ARBDEF <cpd>, <nrf>,
<bin data block>
```

character and the data ends with <pmt>. If less data is sent than the number of points in the waveform the old data is retained from the point where the new data ends. If more data is sent the surplus is discarded.

Define a new or existing arbitrary waveform with name <cpd> and length <nrf> and load with the data in <bin data block>.

If the arbitrary waveform does not exist it will be created. If it does exist the length will be checked against that specified and a warning will be issued if they are different.

The edit limits will be set to the extremes of the waveform.

The data consists of two bytes per point with no characters between bytes or points. The point data is sent high byte first. The data block has a header which consists of the # character followed by several ascii-coded numeric characters. The first of these defines the number of ascii characters to follow and the following characters define the length of the binary data in bytes.

If less data is sent than the number of points in the waveform the old data is retained from the point where the new data ends. If more data is sent the surplus is discarded.

This command cannot be used over the RS232 interface since it contains a binary data block.

Arbitrary Waveform Editing

Care should be taken to ensure that all channels in the instrument are running in CONTINUOUS mode before using commands from this section. Failure to observe this restriction may give unexpected results.

```
ARBEDLMTS <nrf1>, <nrf2>
```

Set the limits for the arbitrary waveform editing functions to start at <nrf1> and stop at <nrf2>.

If both values are set to 0 the commands which use them will automatically place them at the start and end points of the relevant waveform. This automatic mode will remain in effect until the ARBEDLMTS command is issued again with nonzero values. The automatic mode is always selected at power up.

ARBDATACSV <cpd>,
<csv ascii data>

Load data to an existing arbitrary waveform.

<cpd> must be the name of an existing arbitrary waveform.

The data consists of ascii coded values, in the range --2048 to +2047, for each point. The values are separated by a comma character and the data ends with <pmt>.

The data is entered into the arbitrary waveform between the points specified by the ARBEDLMTS command. If less data is sent than the number of points between the limits the old data is retained from the point where the new data ends. If more data is sent the surplus is discarded.

ARBDATA <cpd>,
<bin data block>

Load data to an existing arbitrary waveform.

<cpd> must be the name of an existing arbitrary waveform.

The data consists of two bytes per point with no characters between bytes or points. The point data is sent high byte first. The data block has a header which consists of the # character followed by several ascii coded numeric characters. The first of these defines the number of ascii characters to follow and these following characters define the length of the binary data in bytes.

The data is entered into the arbitrary waveform between the points specified by the ARBEDLMTS command.

If less data is sent than the number of points between the limits the old data is retained from the point where the new data ends. If more data is sent the surplus is discarded.

This command cannot be used over the RS232 interface since it contains a binary data block.

ARBDATACSV? <cpd>

Returns the data from an existing arbitrary waveform.

<cpd> must be the name of an existing arbitrary waveform. The data consists of ascii coded values as specified for the ARBDATACSV command. The data is sent from the arbitrary waveform between the points specified by the ARBEDLMTS command.

ARBDATA? <cpd>	<p>Returns the data from an existing arbitrary waveform.</p> <p><cpd> must be the name of an existing arbitrary waveform.</p> <p>The data consists of binary coded values as specified for the ARBDATA command. The data is sent from the arbitrary waveform between the points specified by the ARBEDLMTS command.</p> <p>This command cannot be used over the RS232 interface since it contains a binary data block.</p>
ARBRESIZE <cpd>, <nrf>	Change the size of arbitrary waveform <cpd> to <nrf>.
ARBRENAME <cpd1>, <cpd2>	Change the name of arbitrary waveform <cpd1> to <cpd2>.
ARBPOINT <cpd>, <nrf1>, <nrf2>	Set the waveform point at address <nrf1> in arbitrary waveform <cpd> to <nrf2>.
ARBLINE <cpd>, <nrf1>, <nrf2>, <nrf3>, <nrf4>	Draw a line in arbitrary waveform <cpd> from start address and data <nrf1> and <nrf2> to stop address and data <nrf3> and <nrf4>.
ARBINSSTD <cpd1>, <cpd2>, <nrf1>, <nrf2>	<p>Insert the standard waveform <cpd2> into the arbitrary waveform <cpd1> from start address <nrf1> to stop address <nrf2>.</p> <p><cpd2> must be one of <SINE>, <SQUARE>, <TRIANG>, <DC>, <POSRMP>, <NEGRMP>, <COSINE>, <HAVSIN>, <HAVCOS>, or <SINC> and <cpd1> must be an existing arbitrary waveform.</p>
ARBINSARB <cpd1>, <cpd2>, <nrf1>, <nrf2>	<p>Insert the arbitrary waveform <cpd2> into arbitrary waveform <cpd1>.</p> <p>Use that part of <cpd2> specified by the ARBEDLMTS command and insert from start address <nrf1> to the stop address <nrf2>.</p> <p><cpd1> and <cpd2> must both be existing arbitrary waveforms but they cannot be the same waveform.</p>
ARBCOPY <cpd>, <nrf1>, <nrf2>, <nrf3>	Block copy in arbitrary waveform <cpd> the data in the address range <nrf1> to <nrf2> to destination address <nrf3>.

ARBAMPL <cpd>, <nrf1>, <nrf2>, <nrf3>	Adjust the amplitude of arbitrary waveform <cpd> in the address range <nrf1> to <nrf2> by the factor <nrf3>.
ARBOFFSET <cpd>, <nrf1>, <nrf2>, <nrf3>	Move the data in arbitrary waveform <cpd> in the address range <nrf1> to <nrf2> by the offset <nrf3>.
ARBINVERT <cpd>, <nrf1>, <nrf2>	Invert arbitrary waveform <cpd> in the address range <nrf1> to <nrf2>.
ARBLLEN? <cpd>	Returns the length, in points, of the arbitrary waveform <cpd>. If the waveform does not exist the return value will be 0.
POSNMKRCLR <cpd>	Clear all position markers from arbitrary waveform <cpd>.
POSNMKRSET <cpd>, <nrf>	Set the position marker at address <nrf> in arbitrary waveform <cpd> to 1 (high).
POSNMKRRES <cpd>, <nrf>	Clear the position marker at address <nrf> in arbitrary waveform <cpd> to 0 (low).
POSNMKRPAT <cpd1>, <nrf1>, <nrf2>, <cpd2>	Put the pattern <cpd2> into the arbitrary waveform <cpd1> from start address <nrf1> to stop address <nrf2>. The pattern may contain up to 16 entries of '1' or '0'; no other characters are allowed.

Waveform Sequence Control

SEQWFM <nrf>, <cpd>	Set the 'waveform' parameter for sequence segment <nrf> to <cpd>. <cpd> must be the name of an existing arbitrary waveform.
SEQSTEP <nrf>, <cpd>	Set the 'step on' parameter for sequence segment <nrf> to <COUNT>, <TRGEDGE> or <TRGLEV>.
SEQCNT <nrf1>, <nrf2>	Set count for sequence segment <nrf1> to <nrf2>.
SEQSEG <nrf>, <cpd>	Set the status of sequence segment <nrf> to <ON> or <OFF>.

Mode Commands

MODE <cpd>	Set the mode to <CONT>, <GATE>, <TRIG>, <SWEEP> or <TONE>.
BSTCNT <nrf>	Set the burst count to <nrf>.
PHASE <nrf>	Set the generator phase to <nrf> degrees. This parameter is used for phase locking and trigger/gate mode start/stop phase.

TONEEND <nrf>	Delete tone frequency number <nrf>, thus defining the end of the list.
TONEFREQ <nrf1>, <nrf2>, <nrf3>	Set tone frequency number <nrf1> to <nrf2> Hz. The third parameter sets the tone type; 1 will give trig, 2 will give FSK, any other value gives gate.
SWPSTARTFRQ <nrf>	Set the sweep start frequency to <nrf> Hz.
SWPSTOPFRQ <nrf>	Set the sweep stop frequency to <nrf> Hz.
SWPCENTFRQ <nrf>	Set the sweep centre frequency to <nrf> Hz.
SWPSPAN <nrf>	Set the sweep frequency span to <nrf> Hz.
SWPTIME <nrf>	Set the sweep time to <nrf> sec.
SWPTYPE <cpd>	Set the sweep type to <CONT>, <TRIG>, <THLDRST> or <MANUAL>.
SWPDIRN <cpd>	Set the sweep direction to <UP>, <DOWN>, <UPDN> or <DNUP>.
SWPSYNC <cpd>	Set the sweep sync <ON> or <OFF>.
SWPSPACING <cpd>	Set the sweep spacing to <LIN> or <LOG>.
SWPMKR <nrf>	Set the sweep marker to <nrf> Hz.
SWPMANUAL <cpd>	Set the sweep manual parameters to <UP>, <DOWN>, <FAST>, <SLOW>, <WRAPON> or <WRAPOFF>.

Input/Output control

OUTPUT <cpd>	Set the main output <ON>, <OFF>, <NORMAL> or <INVERT>.
SYNCOUT <cpd>	Set the sync output <ON>, <OFF>, <AUTO>, <WFMSYNC>, <POSNMKR>, <BSTDONE>, <SEQSYNC>, <TRIGGER>, <SWPTRG> or <PHASLOC>.
TRIGOUT <cpd>	Set the trig output to <AUTO>, <WFMEND>, <POSNMKR>, <SEQSYNC> or <BSTDONE>.
TRIGIN <cpd>	Set the trig input to <INT>, <EXT>, <MAN>, <PREV>, <NEXT>, <POS> or <NEG>.
TRIGPER <nrf>	Set the internal trigger generator period to <nrf> sec.

FORCETRIG Force a trigger to the selected channel. Will function with any trigger source except MANUAL specified.

Modulation Commands

MOD <cpd> Set the modulation source to <OFF>, <EXT> or <PREV>.

MODTYPE <cpd> Set the modulation type to <AM> or <SCM>.

AMDEPTH <nrf> Set the depth for amplitude modulation to <nrf> %.

SCMLEVEL <nrf> Set the level for SCM to <nrf> Volts.

SUM <cpd> Set the sum source to <OFF>, <EXT> or <PREV>.

SUMATN <cpd> Set the sum input attenuator to <0dB>, <10dB>, <20dB>, <30dB>, <40dB> or <50dB>.

SUMRATIO <nrf> Set the sum ratio to <nrf>.

Phase Locking Commands

REFCLK <cpd> Set the **REF CLOCK IN/OUT** to <IN>, <OUT>, <MASTER> or <SLAVE>.

ABORT Aborts an external phase locking operation.

PHASE <nrf> Set the generator phase to <nrf> degrees. This parameter is used for phase locking and trigger/gate mode start/stop phase.

LOCKMODE <cpd> Set the channel lock mode to <INDEP>, <MASTER>, <FTRACK> or <SLAVE>.

LOCKSTAT <cpd> Set the inter-channel lock status to <ON> or <OFF>.

Status Commands

*CLS Clear status. Clears the Standard Event Status Register, Query Error Register and Execution Error Register. This indirectly clears the Status Byte Register.

*ESE <nrf> Set the Standard Event Status Enable Register to the value of <nrf>.

*ESE? Returns the value in the Standard Event Status Enable Register in <nrl> numeric format. The syntax of the response is <nrl><rmt>.

*ESR?	Returns the value in the Standard Event Status Register in <nr1> numeric format. The register is then cleared. The syntax of the response is <nr1><rmt>.
*IDN?	Returns the instrument identification. The exact response is determined by the instrument configuration and is of the form <NAME>, <model>, 0, <version><rmt> where <NAME> is the manufacturer's name, <MODEL> defines the type of instrument and <VERSION> is the revision level of the software installed.
*IST?	Returns ist local message as defined by IEEE Std. 488.2. The syntax of the response is 0<rmt>, if the local message is false or 1<rmt>, if the local message is true.
*OPC	Sets the Operation Complete bit (bit 0) in the Standard Event Status Register. This will happen immediately the command is executed because of the sequential nature of all operations.
*OPC?	Query Operation Complete status. The syntax of the response is 1<rmt>. The response will be available immediately the command is executed because of the sequential nature of all operations.
*PRE <nrf>	Set the Parallel Poll Enable Register to the value <nrf>.
*PRE?	Returns the value in the Parallel Poll Enable Register in <nr1> numeric format. The syntax of the response is <nr1><rmt>.
*SRE <nrf>	Set the Service Request Enable Register to <nrf>.
*SRE?	Returns the value of the Service Request Enable Register in <nr1> numeric format. The Syntax of the response is <nr1><rmt>.
*STB?	Returns the value of the Status Byte Register in <nr1> numeric format. The syntax of the response is <nr1><rmt>.
*WAI	Wait for Operation Complete true. As all commands are completely executed before the next is started this command takes no additional action.
*TST?	The generator has no self-test capability and the response is always 0<rmt>.
EER?	Query and clear execution error number register. The response format is nr1<rmt>.

QER? Query and clear query the error number register. The response format is nr1<rmt>.

Miscellaneous Commands

*LRN? Returns the complete set-up of the instrument as a hexadecimal character data block. To re-install the set-up the block should be returned to the instrument exactly as it is received.
The syntax of the response is LRN <Character data><rmt>.
The settings in the instrument are not affected by execution of the *LRN? command.

LRN <character data> Install data for a previous *LRN? command.

*RST Resets the instrument parameters to their default values (see Appendix).

*RCL <nrf> Recalls the instrument set up contained in store number <nrf>. Valid store numbers are 0 - 9. Recalling store 0 sets all parameters to the default settings (see Appendix).

*SAV <nrf> Saves the complete instrument set up in the store number <nrf>. Valid store numbers are 1 - 9.

*TRG This command is the same as pressing the **MAN TRIG** key. Its effect will depend on the context in which it is asserted. The interface command Group Execute Trigger (GET) will perform the same action as *TRG.

COPYCHAN <nrf> Copy the parameters from the current set-up channel to channel <nrf>.

HOLD <cpd> Set hold mode <ON>, <OFF>, <ENAB> or <DISAB>. The ON or OFF forms are the same as pressing the **MAN HOLD** key. The ENAB and DISAB forms are channel specific and enable or disable the action of the **MAN HOLD** key or **HOLD** input.

FILTER <cpd> Set the output filter to <AUTO>, <EL10>, <EL16>, <BESS> or <NONE>.

BEEPMODE <cpd> Set beep mode to <ON>, <OFF>, <WARN>, or <ERROR>.

BEEP Sound one beep.

LOCAL Returns the instrument to local operation and unlocks the keyboard.
Will not function if LLO is in force.

Refer to chapter15, *Calibration*, for remote calibration commands.

Remote Command Summary

Table 16-1. Remote Command Summary

*CLS	Clear status.
*ESE <nrf>	Set the Standard Event Status Enable Register to the value of <nrf>.
*ESE?	Returns the value in the Standard Event Status Enable Register in <nr1> numeric format.
*ESR?	Returns the value in the Standard Event Status Register in <nr1> numeric format.
*IDN?	Returns the instrument identification.
*IST?	Returns <i>ist</i> local message as defined by IEEE Std. 488.2.
*LRN?	Returns the complete set up of the instrument as a hexadecimal character data block approximately 842 bytes long.
*OPC	Sets the Operation Complete bit (bit 0) in the Standard Event Status Register.
*OPC?	Query operation complete status.
*PRE <nrf>	Set the Parallel Poll Enable Register to the value <nrf>.
*PRE?	Returns the value in the Parallel Poll Enable Register in <nr1> numeric format.
*RCL <nrf>	Recalls the instrument set up contained in store number <nrf>.
*RST	Resets the instrument parameters to their default values.
*SAV	Saves the complete instrument set up in the store number <nrf>. Valid store numbers are 1 - 9.
*SRE <nrf>	Set the Service Request Enable Register to <nrf>.
*SRE?	Returns the value of the Service Request Enable Register in <nr1> numeric format.
*STB?	Returns the value of the Status Byte Register in <nr1> numeric format.
*TRG	This command is the same as pressing the MAN TRIG key.
*TST?	The generator has no self-test capability and the response is always 0<rmt>.
*WAI	Wait for operation complete true. Executed before the next operation is started

ABORT	Aborts a phase locking operation.
AMDEPTH <nrf>	Set the depth for amplitude modulation to <nrf> %.
AMPL <nrf>	Set the amplitude to <nrf> in the units as specified by the AMPUNIT command.
AMPUNIT <cpd>	Set the amplitude units to <VPP>, <VRMS> or <DBM>.
ARB <cpd>	Select an arbitrary waveform for output.
ARBAMPL <cpd>, <nrf1>, <nrf2>, <nrf3>	Adjust the amplitude of arbitrary waveform <cpd> from start address <nrf1> to stop address <nrf2> by the factor <nrf3>.
ARBCLR <cpd>	Delete the arb <cpd> from channel memory.
ARBCOPY <cpd>, <nrf1>, <nrf2>, <nrf3>	Block copy in arbitrary waveform <cpd> the data from start address <nrf1> to stop address <nrf2> to destination address <nrf3>.
ARBCREATE <cpd>, <nrf>	Create a new, blank arbitrary waveform with name <cpd> and length <nrf> points.
ARBDATA <cpd>, <bin data block>	Load data to an existing arbitrary waveform.
ARBDATA? <cpd>	Returns the data from an existing arbitrary waveform.
ARBDATACSV <cpd>, <csv ascii data>	Load data to an existing arbitrary waveform.
ARBDATACSV? <cpd>	Returns the data from an existing arbitrary waveform.
ARBDEF <cpd>, <nrf>, <bin data block>	Define a new or existing arbitrary waveform with name <cpd> and length <nrf> and load with the data in <bin data block>.
ARBDEFCSV <cpd>, <nrf>, <csv ascii data>	Define a new or existing arbitrary waveform with name <cpd> and length <nrf> and load with the data in <csv ascii data>.
ARBDELETE <cpd>	Delete the arbitrary waveform <cpd>.
ARBEDLIMITS <nrf1>, <nrf2>	Set the limits for the arbitrary waveform editing functions to start at <nrf1> and stop at <nrf2>.
ARBINSARB <cpd1>, <cpd2>, <nrf1>, <nrf2>	Insert the arbitrary waveform <cpd2> into arbitrary waveform <cpd1>. Use that part of <cpd2> specified by the ARBLIMITS command and insert from start address <nrf1> to stop address <nrf2>.

ARBINSSTD <cpd1>, <cpd2>, <nrf1>, <nrf2>	Insert the standard waveform <cpd2> into the arbitrary waveform <cpd1> from start address <nrf1> to stop address <nrf2>.
ARBINVERT <cpd>, <nrf1>, <nrf2>	Invert arbitrary waveform <cpd> between start address <nrf1> and stop address <nrf2>.
ARBLLEN? <cpd>	Returns the length, in points, of the arbitrary waveform <cpd>.
ARBLINE <cpd>, <nrf1>, <nrf2>, <nrf3>, <nrf4>	Draw a line in arbitrary waveform <cpd> from start address/data <nrf1>/<nrf2> to stop address/data <nrf3>/<nrf4>.
ARBLIST?	Returns a list of all arbitrary waveforms in backup memory, each will return a name and length in the form <cpd>, <nr1>.
ARBLISTCH?	Returns a list of all arbitrary waveforms channel memory, each will return a name and length in the form <cpd>, <nr1>.
ARBOFFSET <cpd>, <nrf1>, <nrf2>, <nrf3>	Move the data in arbitrary waveform <cpd> from start address <nrf1> to stop address <nrf2> by the offset <nrf3>.
ARBPOINT <cpd>, <nrf1>, <nrf2>	Set the waveform point at address <nrf1> in arbitrary waveform <cpd> to <nrf2>.
ARBRENAME <cpd1>, <cpd2>	Change the name of arbitrary waveform <cpd1> to <cpd2>.
ARBRESIZE <cpd>, <nrf>	Change the size of arbitrary waveform <cpd> to <nrf>.
BEEP	Set beep mode to <ON>, <OFF>, <WARN>, or <ERROR>.
BEEPMODE <cpd>	Sound one beep.
BSTCNT <nrf>	Set the burst count to <nrf>.
CLKFREQ <nrf>	Set the arbitrary sample clock freq to <nrf> Hz.
CLKPER <nrf>	Set the arbitrary sample clock period to <nrf> sec.
COPYCHAN <nrf>	Copy the parameters from the current set-up channel to channel <nrf>.
DCOFFS <nrf>	Set the dc offset to <nrf> Volts.
EER?	Query and clear execution error number register.
FILTER <cpd>	Set the output filter to <AUTO>, <EL10>, <EL16>, <BESS> or <NONE>.
FORCETRIG	Force a trigger to the selected channel.
HOLD <cpd>	Set hold mode <ON>, <OFF>, <ENAB> or <DISAB>.

LOCKMODE <cpd>	Set the channel lock mode to <INDEP>, <MASTER>, <FTRACK> or <SLAVE>.
LOCKSTAT <cpd>	Set the channel lock status to <ON> or <OFF>.
LOCAL	Returns the instrument to local operation and unlocks the keyboard. Will not function if LLO is in force.
LRN <character data>	Install data for a previous *LRN? command.
MOD <cpd>	Set the modulation source to <OFF>, <EXT> or <PREV>.
MODE <cpd>	Set the mode to <CONT>, <GATE>, <TRIG>, <SWEEP> or <TONE>.
MODTYPE <cpd>	Set the modulation type to <AM> or <SCM>.
OUTPUT <cpd>	Set the main output <ON>, <OFF>, <NORMAL> or <INVERT>.
PHASE <nrf>	Set the slave generator phase to <nrf> degrees.
POSNMKRCLR <cpd>	Clear all position markers from arbitrary waveform <cpd>.
POSNMKRPAT <cpd1>, <nrf1>, <nrf2>, <cpd2>	Put the pattern <cpd2> into the arbitrary waveform <cpd1> from start address <nrf1> to stop address <nrf2>.
POSNMKRRES <cpd>, <nrf>	Clear the position marker at address <nrf> in arbitrary waveform <cpd> to 0 (low).
POSNMKRSET <cpd>, <nrf>	Set the position marker at address <nrf> in arbitrary waveform <cpd> to 1 (high).
PULSDLY <nrf>	Set the pulse delay to <nrf> sec.
PULSPER <nrf>	Set the pulse period to <nrf> sec.
PULSWID <nrf>	Set the pulse width to <nrf> sec.
PULTRNBASE <nrf>	Set the pulse-train base line to <nrf> Volts.
PULTRNDLY <nrf1>, <nrf2>	Set the delay of pulse-train pulse number <nrf1> to <nrf2> sec.
PULTRNLEN <nrf>	Set the number of pulses in the pulse-train to <nrf>.
PULTRNLEV <nrf1>, <nrf2>	Set the level of pulse-train pulse number <nrf1> to <nrf2> Volts.
PULTRNMAKE	Make the pulse-train and run it - similar to the WAVE PULSTRN command.
PULTRNPER <nrf>	Set the pulse-train period to <nrf> sec.
PULTRNWID <nrf1>, <nrf2>	Set the width of pulse-train pulse number <nrf1> to <nrf2> sec.

QER?	Query and clear query error number register.
REFCLK <cpd>	Set the ref. clock BNC connector to <IN>, <OUT>, <MASTER> or <SLAVE>.
SCMLEVEL <nrf>	Set the level for SCM to <nrf> Volts.
SETUPCH <nrf>	Select channel <nrf>
SEQCNT <nrf1>,<nrf2>	Set count for sequence segment <nrf1> to <nrf2>.
SEQSEG <nrf>,<cpd>	Set the status of sequence segment <nrf> to <ON> or <OFF>.
SEQSTEP <nrf>,<cpd>	Set the 'step on' parameter for sequence segment <nrf> to <COUNT>, <TRGEDGE> or <TRGLEV>.
SEQWFM <nrf>,<cpd>	Set the 'waveform' parameter for sequence segment <nrf> to <cpd>.
SUM <cpd>	Set the sum source to <OFF>, <EXT> or <PREV>.
SUMATN <cpd>	Set the sum input attenuator to <0dB>, <10dB>, <20dB>, <30dB>, <40dB> or <50dB>.
SUMRATIO <nrf>	Set the sum ratio to <nrf>.
SWPCENTFRQ <nrf>	Set the sweep centre frequency to <nrf> Hz.
SWPDIRN <cpd>	Set the sweep direction to <UP>, <DOWN>, <DNUP> or <UPDN>.
SWPMANUAL <cpd>	Set the sweep manual parameters to <UP>, <DOWN>, <FAST>, <SLOW>, <WRAPON> or <WRAPOFF>.
SWPMKR <nrf>	Set the sweep marker to <nrf> Hz.
SWPSPACING <cpd>	Set the sweep spacing to <LIN> or <LOG>.
SWPSPAN <nrf>	Set the sweep frequency span to <nrf> Hz.
SWPSTARTFRQ <nrf>	Set the sweep start frequency to <nrf> Hz.
SWPSTOPFRQ <nrf>	Set the sweep stop frequency to <nrf> Hz.
SWPSYNC <cpd>	Set the sweep sync <ON> or <OFF>.
SWPTIME <nrf>	Set the sweep time to <nrf> sec.
SWPTYPE <cpd>	Set the sweep type to <CONT>, <TRIG>, <THLDRST> or <MANUAL>.

SYNCOUT <cpd>	Set the sync output <ON>, <OFF>, <AUTO>, <WFMSYNC>, <POSNMKR>, <BSTDONE>, <SEQSYNC>, <TRIGGER>, <SWPTRG> or <PHASLOC>.
TONEEND <nrf>	Delete tone frequency number <nrf> thus defining the end of the list.
TONEFREQ <nrf1>, <nrf2>, <nrf3>	Set tone frequency number <nrf1> to <nrf2> Hz. The third parameter sets the tone type; 1 will give trig, 2 will give FSK, any other value gives gate.
TRIGIN <cpd>	Set the trig input to <INT>, <EXT>, <MAN>, <PREV>, <NEXT>, <POS> or <NEG>.
TRIGOUT <cpd>	Set the trig output to <AUTO>, <WFMENTD>, <POSNMKR>, <SEQSYNC> or <BSTDONE>.
TRIGPER <nrf>	Set the internal trigger generator period to <nrf> sec.
VAIN <cpd>	Set the MODULATION or SUM input to <VCA>, <SUM> or <OFF>.
WAVE <cpd>	Select the output waveform as <SINE>, <SQUARE>, <TRIANG>, <DC>, <POSRMP>, <NEGRMP>, <COSINE>, <HAVSIN>, <HAVCOS>, <SINC>, <PULSE>, <PULSTRN>, <ARB> or <SEQ>.
WAVFREQ <nrf>	Set the waveform frequency to <nrf> Hz.
WAVPER <nrf>	Set the waveform period to <nrf> sec.
ZLOAD <cpd>	Set the output load, which the generator is to assume for amplitude and dc offset entries, to <50> (50 Ω), <600> (600 Ω) or <OPEN>.

Chapter 17

Maintenance

Introduction..... 17-2
Cleaning..... 17-2

Introduction

The manufacturers or their agents overseas will provide a repair service for any unit developing a fault.

Where owners wish to undertake their own maintenance work, this should only be done by skilled personnel in conjunction with the service manual.

Cleaning

If the instrument requires cleaning use a cloth that is only lightly dampened with water or a mild detergent.



To avoid the possibility of electric shock or damage to the instrument, never allow water to get inside the case.



To avoid possible damage to the instrument, never use a solvent to clean it.

Appendices

Appendix	Title	Page
A	Mains Operating Voltage	A-1
B	Warning and Error Messages	B-1
C	SYNC OUT Automatic Settings	C-1
D	Factory System Defaults	D-1
E	Waveform Manager Plus.....	E-1
F	Block Diagrams.....	F-1
G	Front and Rear Panel Drawings	G-1

Appendix A

Mains Operating Voltage

Mains Operating Voltage

Before connecting the instrument to an ac outlet, check that the instrument operating voltage marked on the rear panel is correct for the local supply.



Warning

To avoid the possibility of electric shock, always ensure the instrument is disconnected from the ac supply before opening the case.

If it is necessary to change the operating voltage, proceed as follows:

1. Disconnect the instrument from all voltage sources.
2. Remove the screws which retain the top cover and lift off the cover.
3. Change the transformer connections following the appropriate diagrams below.
4. Refit the cover and the secure with the same screws.
5. To comply with safety standard requirements the operating voltage marked on the rear panel must be changed to clearly show the new voltage setting.
6. Change the fuse to one of the correct rating according to the table below:

Table 1-1. Approved Fuse Types

	Single-channel model 281	Two- and Four-channel models 282/284
For 230 V operation	250 mA (T) 250 V HRC	1 A (T) 250 V HRC
For 100 V or 115 V operation	500 mA (T) 250 V HRC	2 A (T) 250 V HRC

To replace the fuse, disconnect the mains lead from the inlet socket and withdraw the fuse drawer below the socket pins. Change the fuse and replace the drawer.

The use of makeshift fuses and the short-circuiting of the fuse holder are prohibited.

Single Channel Model 281

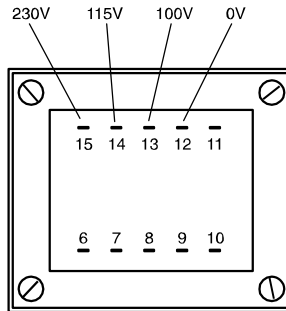

Figure 1-1. Mains Transformer Connections - Model 281

shb0001f.emf

for 230 V operation, connect the live (brown) wire to pin 15
for 115 V operation, connect the live (brown) wire to pin 14
for 100 V operation, connect the live (brown) wire to pin 13

Two- and Four-Channel Models 282 and 284

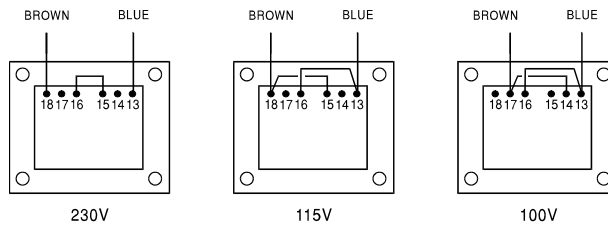

Figure 1-2. Mains Transformer Connections - Models 282 and 284

for 230 V operation, link pins 15 and 16
for 115 V operation, link pins 13 and 16, link pins 15 and 18
for 100 V operation, link pins 13 and 16, link pins 14 and 17

Appendix B

Warning and Error Messages

Warning and Error Messages

Warning messages are given when a setting may not give the expected result, e.g. DC Offset attenuated by the output attenuator when a small amplitude is set; the setting is, however, implemented.

Error messages are given when an illegal setting is attempted; the previous setting is retained.

The last two warning/error messages can be reviewed by selecting LAST ERROR from the UTILITY screen, the latest is reported first.

Warning and error messages are reported with a number on the display; only the number is reported via the remote control interfaces.

The following is a complete list of messages as they appear on the display.

Warning Messages

- 00 No errors or warnings have been reported
- 13 DC offset changed by amplitude
- 14 Offset + SUM + level may cause clipping
- 23 Offset will clip the waveform
- 24 Instrument not calibrated
- 30 Amplitude will clip the waveform
- 42 Trigger source is fixed to external in SWP/SLAVE mode
- 43 Arb repeated in two seq segs so SEQ SYNC may not be correct
- 59 Trigger slope is fixed to positive in SWEEP/SLAVE mode
- 81 The programmed mod depth cannot be set

83 Numeric value too large - switching to sample period

Error Messages

- 101 Frequency out of range for the selected waveform
- 102 Sample clock frequency required exceeds 40 MHz
- 103 Sample clock frequency required is less than 0.1 Hz
- 104 Pulse/pulse-train period out of range for current set-up
- 105 Pulse width cannot be greater than the period
- 106 Absolute value of pulse delay must be < period
- 107 Pulse width cannot be less than 25 ns
- 108 Maximum output level exceeded
- 109 Minimum output level exceeded
- 110 Minimum dc offset value exceeded
- 111 Maximum dc offset value exceeded
- 112 The value entered is out of range
- 115 There are no arb waveforms defined Use WAVEFORM CREATE
- 116 Cannot delete arb while it is selected for any output chan
- 117 Arb name exists, names must be unique
- 118 Arb waveform length exceeds available memory
- 119 Arb waveform length cannot be less than four points
- 121 Start address error: must be in the range $0 \leq n \leq \text{stop addr}$
- 122 Stop address error: must be in the range $\text{strt} \leq n \leq \text{wfm len}$
- 125 No GPIB available
- 127 System ram error check battery
- 128 Point value error: must be in the range $-2048 \leq n \leq +2047$
- 129 Wave offset error: must be in the range $-4096 \leq n \leq +4095$
- 131 Wave amplitude error must be in the range $0 \leq n \leq 100$
- 132 Block dest error: must be in the range $0 \leq n \leq \text{wfm len}-4$
- 133 Sequence count value exceeds the maximum of 32,768
- 134 Sequence count value cannot be less than 1
- 135 Trigger generator maximum period is 200 s
- 136 Trigger generator minimum period is 10 us
- 138 Burst count value exceeds the maximum of 1,048,575
- 139 Burst count value cannot be less than 1
- 140 Trig/Gate freq too high. Max=1 MHz. Continuous mode set
- 141 Selected function is illegal in tone mode TONE MODE CANCELLED!
- 144 Selected combination of function and mode is illegal

- 145 Selected mode is not available when phase lock master or slave
- 146 Cannot delete arbs while a sequence is running
- 147 Current set-up requires an arb wfm which does not exist
- 148 Trig/gate mode and seq step value cause a trigger conflict
- 149 Seq step value can't mix edge and level between segments
- 150 Number of pulses in train must be between 1 and 10
- 151 Pulse train base level must be >-5.0 V and <+5.0 V
- 152 Pulse level must be >-5.0 V and <+5.0 V
- 153 Pulse number must be between 1 and 10
- 154 Sweep frequency values must be 0.001 mHz to 16 MHz
- 155 Sweep start freq must be less than stop freq
- 156 Sweep stop freq must be greater than start freq
- 157 Sweep time value is out of range $0.03 \text{ s} < n < 99 \text{ s}$
- 158 Sweep marker value is out of range $0.001 \text{ Hz} < n < 16 \text{ MHz}$
- 160 Not locked. This error indicates that a phase locking operation has failed.
- 161 Illegal phase value
- 178 SUM ratio is not possible within level constraints
- 179 SUM and internal MOD cannot be active together
- 180 Modulation depth or SCM level is out of range
- 182 This channel's waveform ram is full
- 184 SUM or Modulation conflict
- 186 Inter channel lock not possible. Lock status is off.

This error may occur for several reasons. In each case there is a conflict of the phase locking settings. In most cases the status of the phase lock is set to off. Any of the following conditions will cause this error:

1. More than one master channel is enabled.
2. No master channel is enabled.
3. The locked channels contain a mixture of DDS and PLL generated waveforms.
4. Frequency tracking is enabled (mode: master/freq) but the frequencies are not the same on all channels. If PLL waveforms are locked the mode will be forced to frequency tracking.
5. A locked channel is not set to continuous mode.
6. An attempt is made to turn on phase lock with a frequency set too high. Note that the maximum frequency for phase locked DDS operation is 10 MHz.
7. An attempt is made to set the frequency too high during phase lock. This error does not set phase lock to off, the system simply inhibits the setting of the incorrect frequency.

Remote Warnings

72 Length is different to that in the ARBDEF (CSV) command

Remote Errors

- 120 Waveform limit value out of range
- 126 Illegal store number requested
- 162 Byte value outside the range 0 to 255
- 163 Specified arb name does not exist
- 164 Command illegal in sweep or tone mode
- 165 Cannot set waveform frequency or period for a sequence
- 166 Cannot set sample frequency or period for std waveforms
- 167 dBm output units assume a 50 Ohm termination
- 168 Specified units illegal for the selected waveform
- 169 Command not available for RS232
- 170 Length value error in binary block
- 171 Illegal value in arbitrary data
- 173 Illegal tone number
- 174 Illegal sequence segment number
- 175 Cannot insert arb into itself
- 176 Pattern value is illegal or pattern too long
- 177 Illegal remote calibration command.
- 185 Command not available while sweeping.

Appendix C

SYNC OUT Automatic Settings

SYNC OUT Automatic Settings

The following automatic source (src) settings are made when auto mode is selected on the SYNC OUTPUT SETUP screen.

MODE	WAVEFORM	Waveform Sync	Position Marker	Burst Done	Sequence Sync	Trigger	Sweep Trigger	Phase Lock
Continuous	Standard	✓						
	Arbitrary	✓						
	Sequence				✓			
Gate/Trig	All					✓		
Sweep	All						✓	
Tone	All					✓		
Ext. phase	Sequence				✓			
Lock Master	All others							✓

Appendix D

Factory System Defaults

Factory System Defaults

The factory system defaults are listed in full below. They can be recalled by pressing **RECALL** followed by `set defaults` or by the remote command `*RST`. All channels will be receive the same set-up. All channels default to the same settings.

Main Parameters

Std. Wave:	Sine
Frequency:	10 kHz
Output:	+2.0 V p-p; Output Off
DC Offset:	0 V
Zout:	HiZ

Gate/Trigger Parameters

Source:	Internal
Period:	1 ms
Slope:	Positive
Burst Count:	1
Phase	0 deg

Modulation Parameters

Source:	Off
Type:	AM/VCA
Depth:	30 %
Sum:	Off

Sweep Parameters

Begin Frequency:	100 kHz
End Frequency:	10 MHz
Marker Frequency:	5 MHz
Direction:	Up

Spacing:	Log
Sweep Time:	50 ms
Type:	Continuous

Sequence

All segments set as follows:

Status:	Off except segment 1
Wfm:	First arb
Step ON	Count
Count:	1
Arbitrary	All unaffected by reset or *RST

Other

Filter	Auto
Sync Out	Auto

Appendix E

Waveform Manager Plus

Arbitrary Waveform Creation and Management Software

The Waveform Manager Plus program allows construction, editing, exchange, translation and storage of many types of waveform data. It is compatible with many popular DSOs and waveform generation products.

Waveforms may be generated by equation entry, freehand drawing, combining existing waveforms or any combinations of these methods.

Data upload and download are possible via RS232 (COM1 to COM4) or GPIB subject to a compatible GPIB card being correctly installed and configured in your PC.

Both upload and download of waveform data are possible and, where applicable, data exchange via 3.5 inch floppy disks in the Tektronix *.ISF format is available.

Text data may be read from the Windows clipboard and used to create a waveform. The text data format is very free and will allow most lists of numbers, with or without intervening text, to be read as waveform data points. Waveform data may also be pasted to the clipboard for insertion into other programs.

Waveforms are displayed in fully scaleable windows and may be manipulated graphically. Any number of waveforms in any of the supported types may be displayed simultaneously.

On-line help is available in three ways.

1. The help menu contains a contents option from which you can go to any section of the on-line help file or browse particular areas or the whole file. It is also possible to use the Index and Find operations of the Windows help system to search for items which are not listed directly in the contents section.
2. Some dialog boxes have a Help button which, when clicked, will open the on-line help file at the section containing the description of that dialog box.
3. From most windows/dialogues the F1 key will open the help file at the relevant section.

Waveform Manager allows you to keep waveforms for different projects separate from each other on your hard drive. A project may be placed anywhere, in any directory (folder) and all waveform files for that project will be stored in a structure below that directory. A project is identified by a user defined name. Each project maintains its own library of expressions.

Appendix F Block Diagrams

Block Diagrams

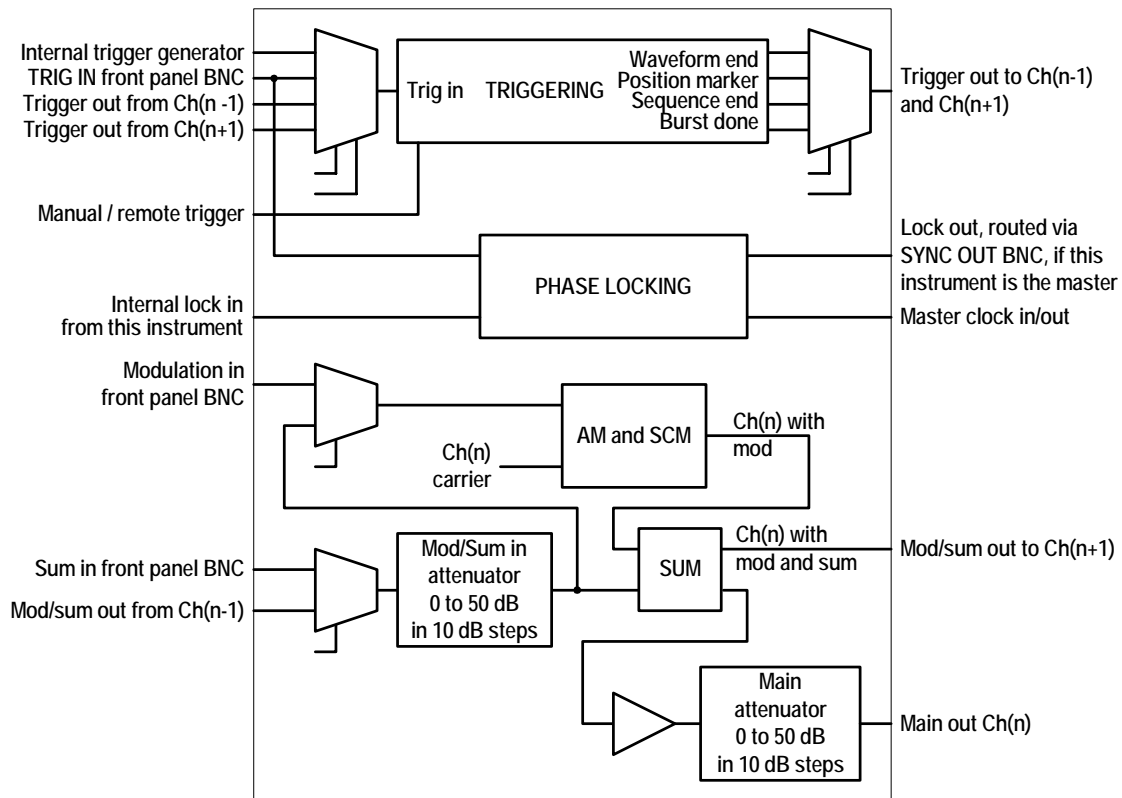

Figure 6-1. Block Diagram: Single Channel

shb0016f.emf

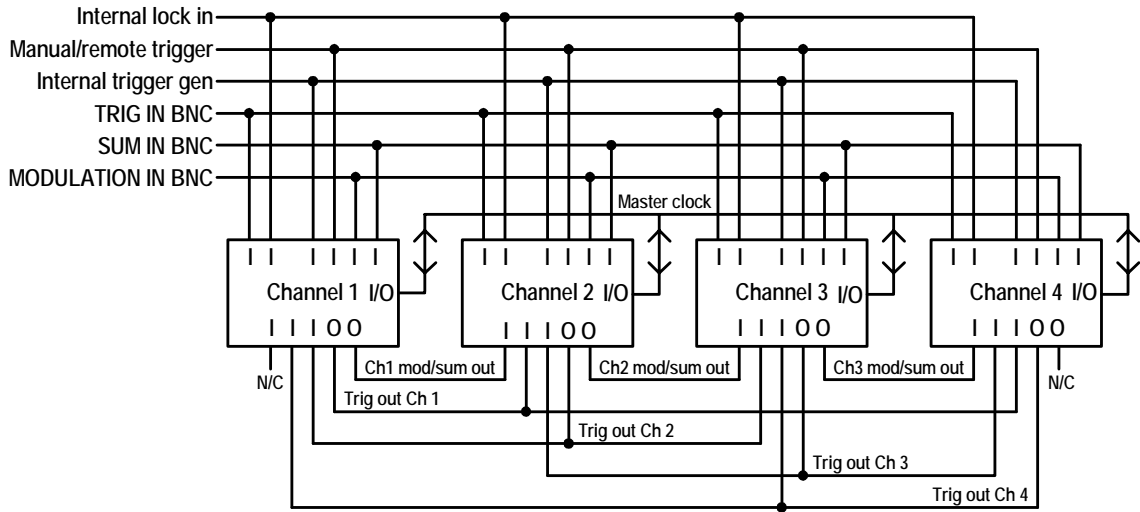

Figure 6-2. Inter-Channel Block Diagram

shb0017f.emf

Appendix G

Front and Rear Panel Drawings

Front Panel: Single-Channel Model 281

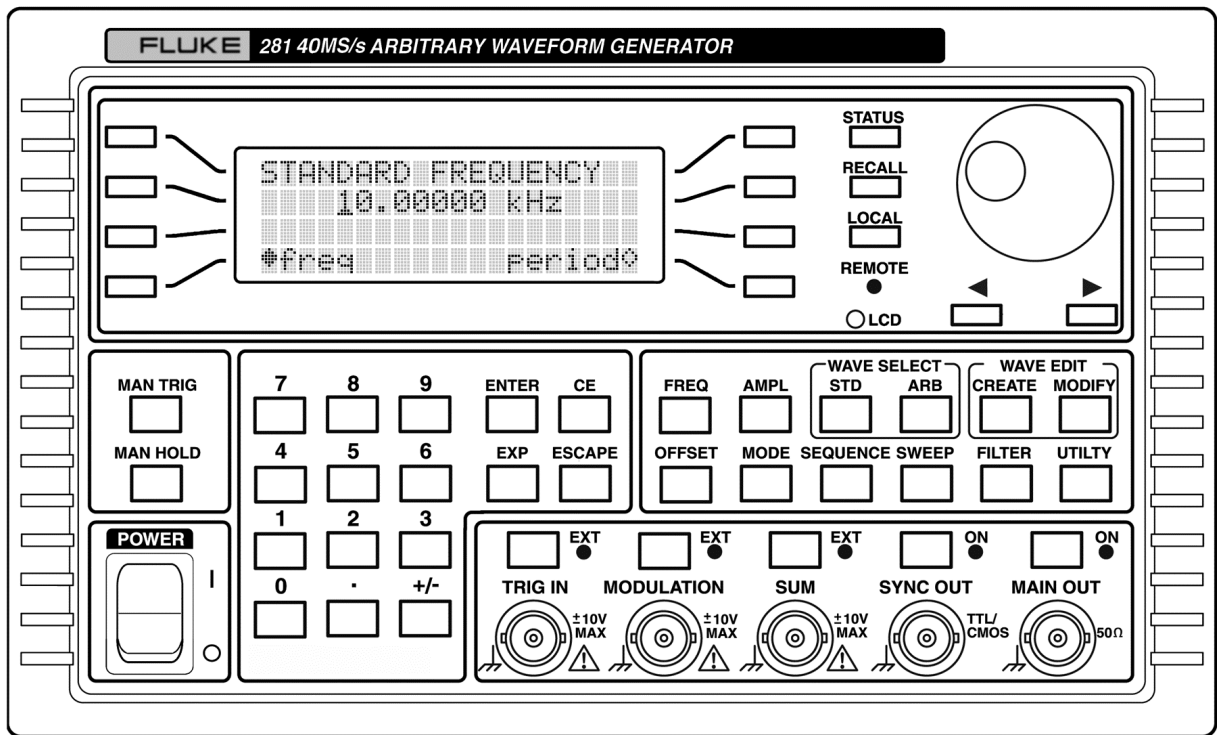

shb0013f.gif

Figure 7-1. Front Panel - Model 281

Front Panel: 2-Channel Model 282

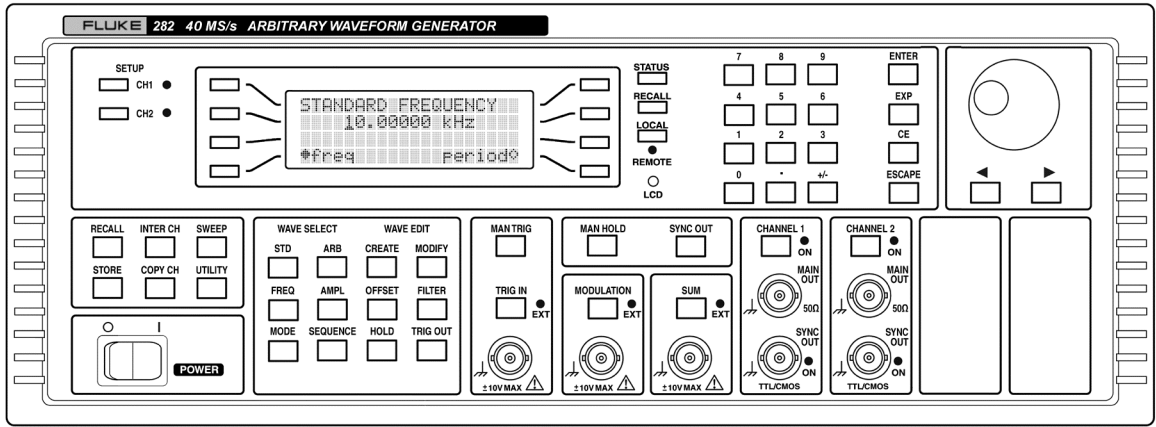

shb0014f.gif

Figure 7-2. Front Panel - Model 282

Front Panel: 4-Channel Model 284

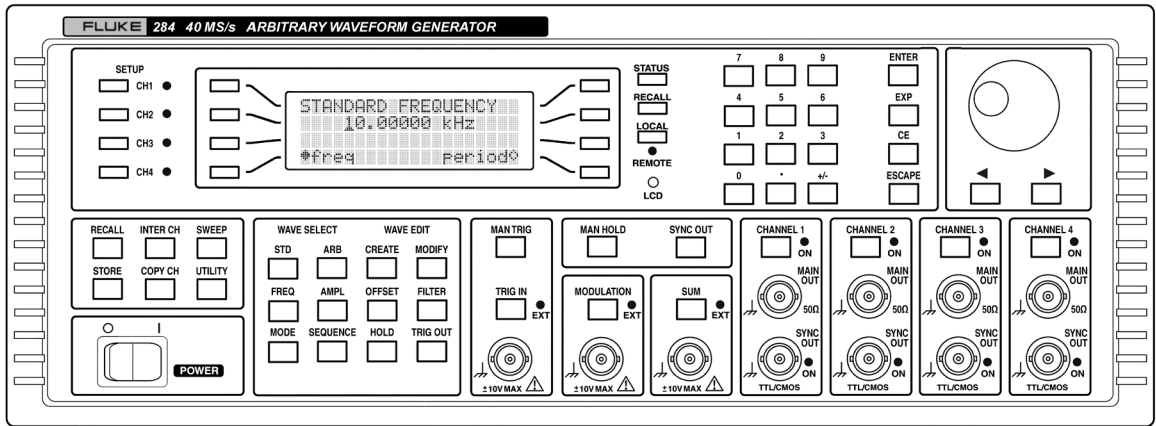

shb0015f.gif

Figure 7-3. Front Panel - Model 284

Rear Panel: Single-Channel Model 281

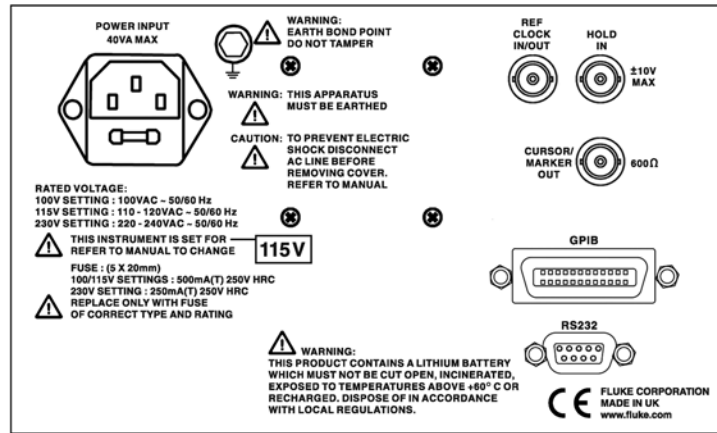

Figure 7-4. Rear Panel - Model 281

shb0018f.gif

Rear Panel: 2- and 4-Channel Models 282 and 284

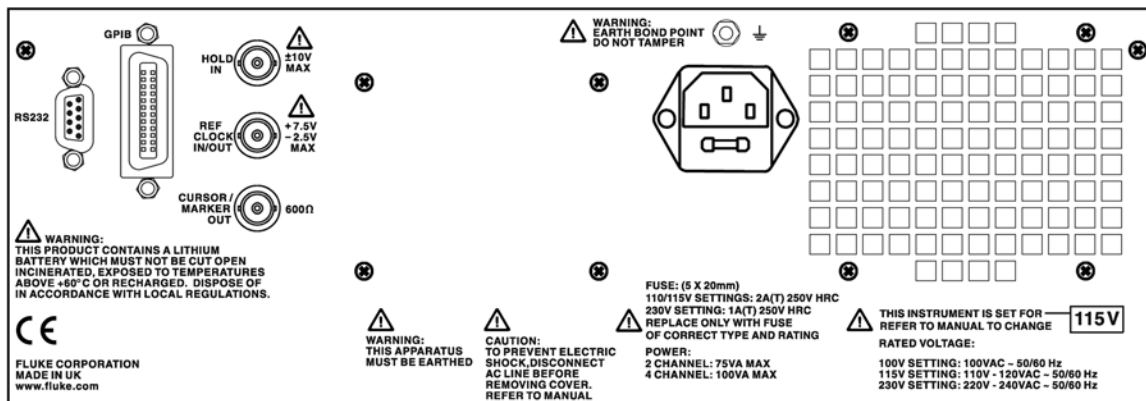

Figure 7-5. Rear Panel - Models 282 and 284

shb0019f.gif

Index

—A—

- adding waveforms, 12-2
- address
 - remote, 16-2, 16-3
- amplitude modulation, 11-2
- arb, 9-2
- arbitrary waveform, 9-2

—B—

- burst count, 7-4

—C—

- calibration, 14-5, 15-2
 - remote, 15-5
- cleaning, 17-2
- clipping, 11-3, 12-2
- clock synthesis, 4-5
- commands
 - remote, 16-10
- connections
 - daisy-chain, 16-4
 - front panel, 3-2
 - rear panel, 3-3
 - RS232, 3-4
 - sweep, 6-2
 - synchronization, 13-5
- creating
 - arbitrary waveform, 9-2

—D—

- daisy-chain, 16-3
- data entry, 4-3
- DC offset, 9-11
- direct digital synthesis, 4-5, 4-6
- display, 4-2
- drawings

- front-panel, G-1
- rear-panel, 7-3
- DTMF, 1-7, 8-4, 12-2

—E—

- editing
 - arbitrary waveform, 9-2
 - principles of, 4-3
- error messages, 14-3

—F—

- features, 1-2
- filter
 - output, 9-18
- frequency locking, 13-2
- frequency shift keying, 8-3
- front-panel, G-1
- FSK, 8-3
- fuse, 2-2, A-1

—G—

- gate
 - polarity, 7-6
 - source, 7-6
 - sync out, 7-7
- GPIO, 3-5, 16-2, 16-6
 - error handling, 16-6
 - IEEE 488.1 subsets, 16-6
 - parallel poll, 16-7
 - power-on status, 16-9
 - status reporting, 16-7

—I—

- IEEE-488, 3-5
- information
 - system, 14-4
- inputs, 1-8

- clock, 1-8, 3-3
- ext sum, 12-2
- hold, 1-8, 3-4, 10-7
- modulation, 1-8, 3-3, 11-3
- ref clock, 14-3
- sum, 1-8, 3-3
- trig, 1-8, 3-3
- trig in, 11-3
- inter-channel
 - modulation, 1-9
 - operation, 1-9
 - phase locking, 1-9
 - summing, 1-9
 - triggering, 1-10
- interfaces, 1-10

—K—

- key
 - ampl, 4-3
 - copy ch, 4-3, 14-5
 - data entry, 4-3
 - freq, 4-3
 - inter ch, 4-3
 - local, 16-2
 - man hold, 4-3, 10-7
 - man trig, 4-3, 7-4, 13-7
 - mode, 4-3
 - modulation, 4-3
 - numeric, 4-3
 - offset, 4-3
 - recall, D-1
 - setup, 4-2, 4-3
 - status, 4-2, 4-3
 - sum, 4-3
 - sweep, 4-3, 6-3
 - sync out, 4-3
 - trig in, 4-3, 7-2
 - utility, 4-3, 14-2
 - wave edit, 4-2
 - wave select, 4-2

—M—

- mains operating voltage, A-1
- maintenance, 17-2
- master-slave, 13-2
- memory, 9-2
 - waveform, 14-2
- menu
 - utility, 14-2
- messages
 - error, B-1
 - errors and warnings, 14-3
 - remote, B-4
 - warning, B-1
- mode
 - addressable, 16-5

- gated, 7-6
- listen, 16-5
- tone, 8-2
- triggered burst, 7-3
- modes, 1-5
- modulation, 1-9, 11-2
 - internal, 11-3
- mounting, 2-2

—N—

- name
 - waveform, 9-5

—O—

- operation
 - principles of, 4-5
- outputs, 1-7
 - clock, 1-8, 3-3
 - cursor/marker, 1-8, 3-4, 6-2, 14-3
 - main, 1-7, 3-2
 - ref clock, 14-3
 - sync, 1-7, 3-2, 5-6, C-1

—P—

- password
 - calibration, 15-3
- phase locking, 1-9, 13-4
- power-up, 4-2
- pulse, 10-2
- pulse train, 10-4

—R—

- RAM, 9-2
- rear-panel, 7-3
- remote
 - control codes, 16-4
 - daisy-chain, 16-3
- remote commands, 16-10
- remote control, 16-2
- repair service, 17-2
- RS232, 3-4, 16-2, 16-3

—S—

- screen
 - AMPLITUDE, 5-3
 - ARB HOLD INPUT, 9-16
 - ARBS, 9-4
 - CALIBRATION, 15-2
 - CHANNEL WFM INFO, 14-2
 - COPY CH, 14-5
 - CREATE NEW WAVEFORM, 9-4
 - CURSOR/MARKER OUTPUT, 14-4
 - DC OFFSET, 5-4
 - error settings, 14-3
 - FILTER SETUP, 9-17

- INTER-CH, 13-2
 - MANUAL SWEEP FREQ, 6-5
 - MODE, 7-2
 - MODULATION, 11-2
 - POSITION MARKER, 9-12
 - POWER ON SETTING, 14-4
 - PULSE, 10-2
 - PULSE TRAIN, 10-4
 - REF CLOCK I/O, 13-6
 - REMOTE, 16-2
 - SEQUENCE, 9-13
 - STANDARD FREQUENCY, 5-2
 - STANDARD WAVEFORMS, 5-2
 - SUM, 12-2, 12-3
 - SWEEP MARKER FREQ, 6-6
 - SWEEP RANGE, 6-3
 - SWEEP SETUP, 6-3
 - SWEEP SPACING, 6-6
 - SWEEP TIME, 6-4
 - SWEEP TYPE, 6-4
 - SYNC OUT, 5-7
 - TONE, 8-2
 - TRIGGER IN, 7-2, 7-4, 7-6
 - TRIGGER OUT, 7-3
 - TRIGGER/GATE SETUP, 7-4, 7-6
 - WAVE OFFSET, 9-11
 - settings
 - automatic sync, C-1
 - default, D-1
 - errors and warnings, 14-3
 - factory, D-1
 - output filter, 9-17
 - power-on, 14-4, 16-2, 16-9
 - sync out, 9-16
 - setup
 - master-slave, 13-3, 13-5
 - remote interface, 14-3
 - store and recall, 14-2
 - synchronization, 13-5
 - specifications, 1-4
 - sum, 12-2
 - summing, 1-9
 - suppressed carrier modulation, 11-2
 - sweep, 6-2
 - hold, 6-6
 - manual, 6-5
 - marker, 6-6
 - range, 6-3
 - spacing, 6-6
 - time, 6-4
 - type, 6-4
 - synchronization, 13-2
 - connections, 13-5
 - principles, 13-5
 - system information, 14-4
-
- T—**
 - tone, 8-2
 - tone switching, 1-6
 - trigger
 - edge, 7-4
 - external, 7-3
 - phase, 7-6
 - source, 7-4
 - sync out, 7-7
 - triggering, 1-10
-
- U—**
 - utility menu, 14-2
-
- V—**
 - voltage controlled amplitude, 11-2
-
- W—**
 - warnings, 14-3
 - waveform
 - arbitrary, 9-2
 - copy, 9-5, 9-10
 - editing, 9-9
 - hold, 10-6
 - information, 14-2
 - modify, 9-6
 - phase, 13-4
 - pulse, 10-2
 - sum, 12-2
 - waveform hold, 9-16