

# LW Wireless Lodge Watch Installation Sheet

**IMPORTANT!** If door/window sensors are included with receiver module as part of a kit, they are already factory linked. If sensors are provided separately, they will require linking to the receiver module.

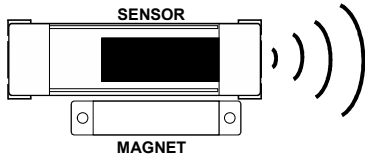

**Note:** Lodge Watch Receiver Module is for indoor use and installation only. For outdoor installation of the receiver module, make sure to specify the Lodge Watch system in a water-tight enclosure. LW1-WT, LW2-WT, LW3-WT, LW4-WT. Door/Window sensors are only for indoor use. There are no door/window sensors available for outdoor use.

## SEQUENCE OF OPERATION:

The Lodge Watch is a wireless monitoring and control system designed to reduce energy waste in vacation and managed properties. This is achieved by turning off the HVAC equipment when the doors or windows are left open for more than two minutes. When a door or window is opened, a magnet separates from the wireless sensor mounted on the door or window frame. The sensor then sends a signal to the receiver module. If the door or window remain open for more than 2 minutes, the module opens the normally closed "OP" contacts, shutting off the HVAC equipment.

## LW-TR DOOR/WINDOW SENSOR:

The LW-TR Door/Window Sensor is a wireless solar-powered sensor that is **factory linked** to the Lodge Watch receiver module and sends a wireless signal whenever a door or window opens or closes. The sensor is easy to install on door and window frames. As many as 30 LW-TR Door/Window Sensors can be used with a single Lodge Watch Receiver. Typical range is 100 feet.

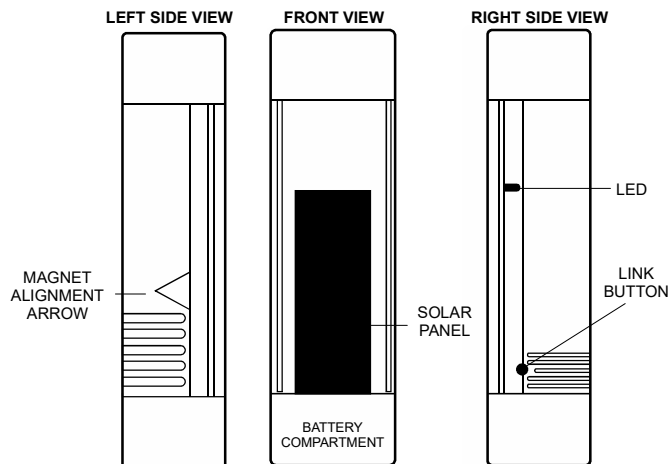

LW LODGE WATCH RECEIVER MODULE

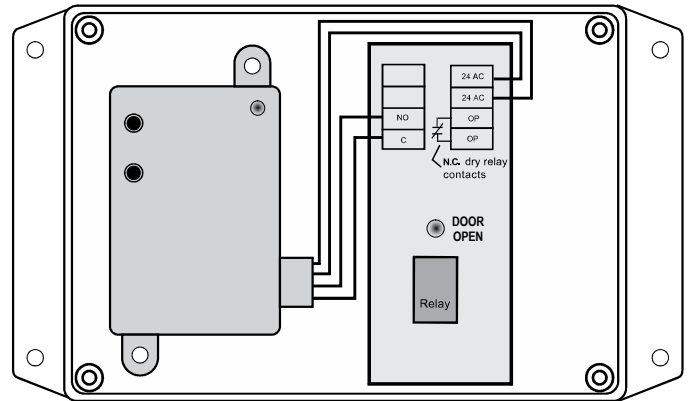

Features include:

- Sends wireless signal to the Lodge Watch receiver whenever a door or window opens or closes.
- Harvests ambient solar energy to power the sensor and send wireless communications.
- Mounts easily on standard doors and windows.
- Supplemental battery power for extreme low-light conditions. Battery has been installed at the factory.

## LW-TR SPECIFICATIONS:

Minimum Illumination:

400 lux hours per day  
e.g.. 100 lux for 4 hours or 200 lux for 2 hours

Start-up Time:

Less than 2.5 min @ 400 lux

Operating Life in Darkness (after full charge):

Min 10 days signs-of-life only

Operating Life in Darkness (with battery backup):

Min 5 years

Maximum Sensor Gap:

0.25" (6mm)

Sensor Dimensions:

3.00" L x 0.87" W x 0.59" D (76mm x 22mm x 15mm)

Sensor Dimensions (with mounting plate):

3.15" L x 0.94" W x 0.73" D (80mm x 24mm x 19mm)

Magnet Dimensions:

2.00" L x 0.40" W x 0.30" D (50mm x 10mm x 7mm)

Environment:

Indoor use only  
-4 to 140 F (-20 to 60 C)  
5 to 93% relative humidity (non-condensing)

Approvals:

RoHS

Agency Compliance:

FCC ID: SZV-STM 320U  
IC: 5713A-STM 320U

## LODGE WATCH RECEIVER MODULE:

The Lodge Watch Receiver Module contains a wireless relay receiver and interface board that wires to the HVAC equipment. The receiver module is powered by 24 Volts AC from the equipment transformer.

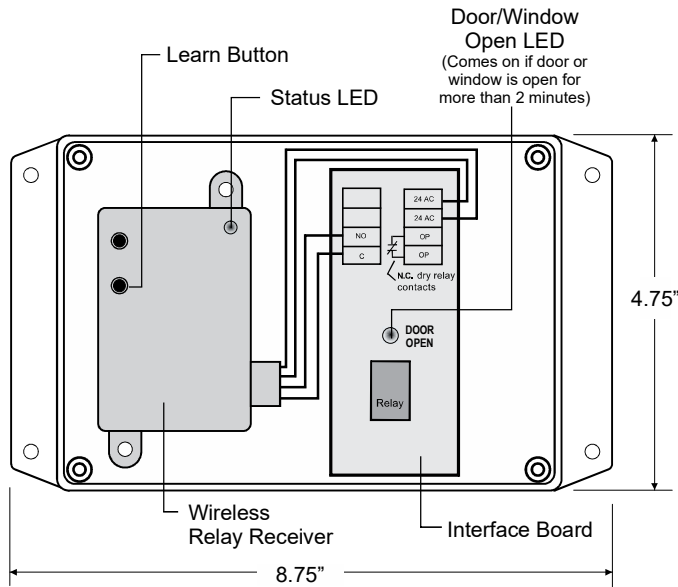

## LODGE WATCH SPECIFICATIONS:

### Wireless Relay Receiver (Indoor Use Only)

- # Relays & Contact Type: One (1) SPDT Continuous Duty Coil
- Expected Relay Life: 10 million cycles minimum mechanical
- Operating Temperature: -30 to 140° F
- Humidity Range: 5 to 95% (noncondensing)
- Red LED: Relay Status / Learn Mode Status (Flashing)
- Approvals: UL Listed, UL916, C-UL
- Agency Compliance: FCCID: SZV-TCM320U  
IC: 5713A-TCM320U
- Frequency: 902 MHz
- Receiver Sensitivity: -93 dBm typical
- Conducted Power: 5 mW typical

### Interface Board (Indoor Use Only)

- # Relays & Contact Type: One (1) SPDT Continuous Duty Coil
- Expected Relay Life: 10 million cycles minimum mechanical
- Operating Temperature: -30 to 140° F
- Humidity Range: 5 to 95% (noncondensing)
- Green LED: Comes on if door or window are left open for 2 minutes opening OP contacts
- System Input Voltage: 24 VAC

## PLANNING:

1. Based on your requirements, decide where to install the sensor and the magnet. For door installations, locate the sensor:
  - On the knob side of the door jamb, away from hinges.
  - At least 1 ft. above the floor to avoid damage.
 For window installations, make sure the location does not expose the sensor to contact with water.
2. Follow the installation and alignment requirements.

3. Install the sensor on the interior side of the fixed frame.

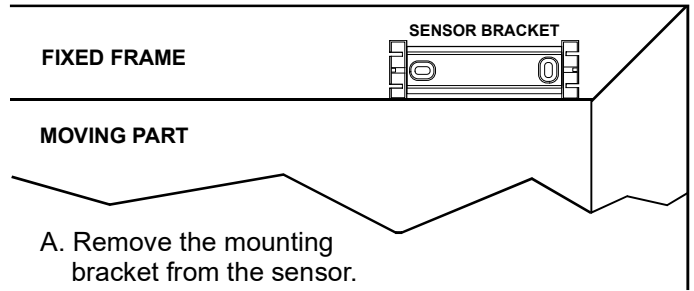

- A. Remove the mounting bracket from the sensor.
- B. Position the bracket so that it is as close to the bottom edge of the frame.
- B. Position the mounting bracket and mark the two mounting screw drill points.
- C. Insert the first screw loosely and level the mounting bracket.
- D. Install the second screw, and then hand-tighten the first screw.
- E. Snap the sensor into the mounting bracket so that the arrow on the side is facing towards the moving part.

Note: If the frame is metal, use the two-sided tape included with the kit.

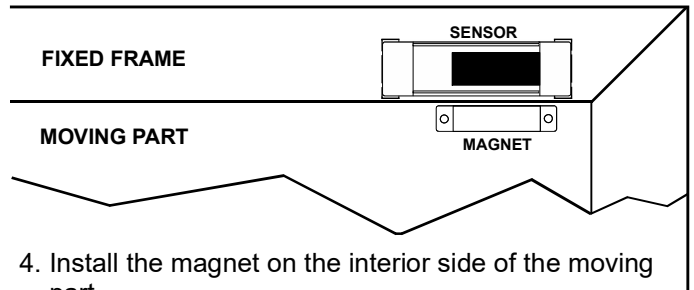

4. Install the magnet on the interior side of the moving part.

- A. Remove the two-sided tape on the back of the magnet and position it so that it is centered with the sensor arrow with no more than a .25" gap between the magnet and the sensor.
- B. Mark the two mounting screw drill points and use the screws provided to secure the magnet to the surface.

Note: If the moving part is metal, use the two-sided tape attached to the magnet and make sure it is firmly secure to the surface.

## MAGNET ALIGNMENT SIDE VIEW

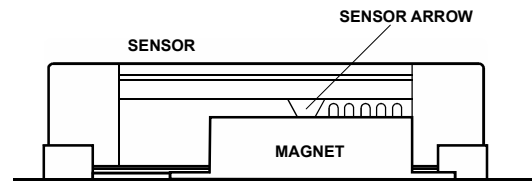

POSITION MAGNET SO THAT IT IS IN THE CENTER OF THE ARROW

## LODGE WATCH RECEIVER INSTALLATION:

1. Mount the Lodge Watch Receiver on a non-metallic surface near the HVAC unit.
2. Turn off power to the HVAC system and wire as illustrated.

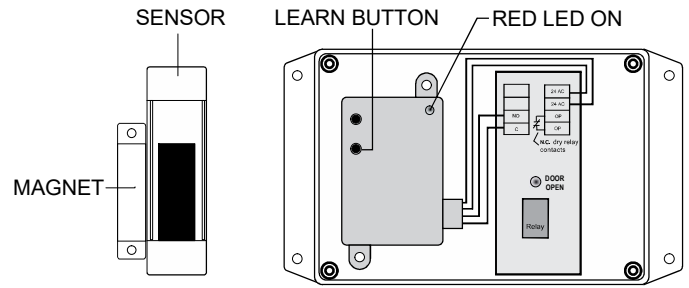
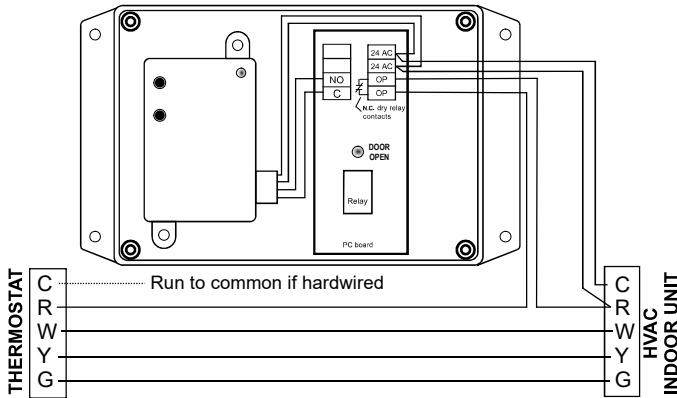

6. Repeat Steps 5 through 7 to link each additional sensor.

## TEST, CHECK AND STARTUP:

1. Once all sensors are properly mounted and all windows and doors are closed, place the thermostat in the continuous fan mode.
2. Open a door or window to separate the magnet from the sensor.
3. The red LED on the relay receiver will go out.
4. After 2 minutes, the green LED on the interface board will come on and the air handler will stop running.
5. Test each sensor in this manner to confirm communications with the relay receiver.

## LINKING ADDITIONAL SENSORS:

1. Apply power to the HVAC system and put the thermostat in the off position.
2. Take each door/window sensor that will be used and separate the magnet.
3. Press and release the LEARN button on the relay receiver. The red LED begins to blink.

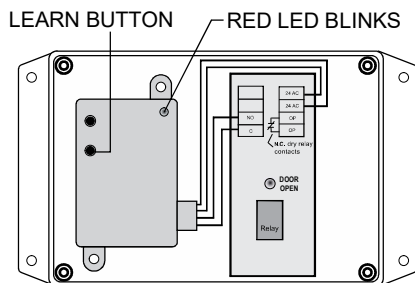

4. Use the paperclip provided in the kit and press the LINK button on the side of the sensor. The red LED on the relay receiver will light solid for 2 seconds then go out.

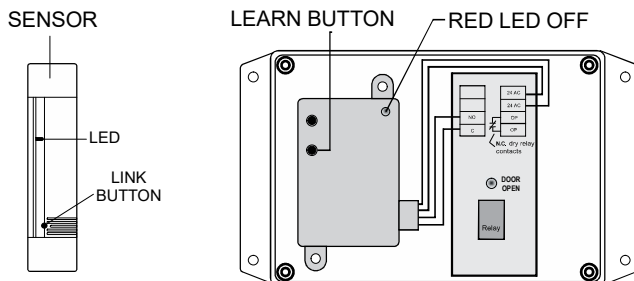

5. To confirm that the sensor is linked with the receiver, place the magnet next to the sensor. The relay receiver red LED will come on confirming that the sensor is linked.

## REPLACING DOOR/WINDOW SENSOR BATTERIES:

Each door/window sensor has a battery installed which is used to supplement the solar energy harvester. The battery maintains power where light levels are consistently too low. Only use a CR1225 battery replacement.

1. Remove the sensor from its mounting bracket.
2. Remove the bottom cap which is closest to the solar panel.
3. Remove the old battery and insert a new one with the positive (+) side up and slide it between the two contact terminals with your finger.
4. Replace the bottom cap and reinsert the sensor back into its mounting bracket making sure that the arrow on the side is facing the magnet.

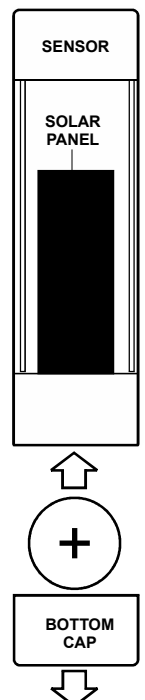

**WARNING:** Ensure the battery is properly oriented. Improper handling of lithium batteries may result in heat generation, explosion, or fire. Dispose of old battery in a safe and proper manner. Keep away from children. If swallowed, promptly seek medical attention.

## TROUBLESHOOTING:

Problem	Solution Checklist
The sensor does not generate a wireless signal	<ul style="list-style-type: none"> <li>• Verify there is a faintly audible click when the contact is closed and opened</li> <li>• Verify the LED blinks once when the contact is closed and opened</li> <li>• Verify the solar cell is charged properly</li> <li>• Check that the magnet is oriented to the sensor properly</li> <li>• Check that the alignment arrows are not spaced more than .25 inch (6.4 mm)</li> </ul>
The linked device does not respond to wireless signal	<ul style="list-style-type: none"> <li>• Check for environment or range issues. Tip: Re-orienting the sensor may overcome adverse RF conditions</li> <li>• Verify the device is linked</li> <li>• Check the transceiver connection and the wiring for errors</li> <li>• Check if appropriate devices are linked according to good system planning</li> </ul>

4. After Global Clear, Lodge Watch receiver will default to Single Contact Mode.

**If multiple door/window sensors are linked, use the following steps to put into Multi-sensor Mode:**

1. Apply power to receiver module.
2. Press and hold LEARN button for 1/2 second. LED will flash slowly.
3. Press and hold LEARN button for 3 seconds until LED pattern changes to FLASH, FLASH, OFF (2 flashes).
4. Press and hold the CLEAR button for 3 seconds until LED links twice indicating Multi-sensor Mode is enabled.
5. When linked with multiple door/window sensors, relay will deactivate if any sensor transmits an OPEN contact.

**NOTE:** It is recommended that door/window sensors be linked before relay is configured for Multi-sensor Mode.  
See Linking Additional Door/Window Sensors.

## GLOBAL CLEAR:

The Lodge Watch receiver and all linked door/window sensors can be cleared and the relay will revert to its original factory default setting of Single Contact Mode. This mode will not work with multiple door/window sensors and the Lodge Watch receiver will have to be reconfigured.

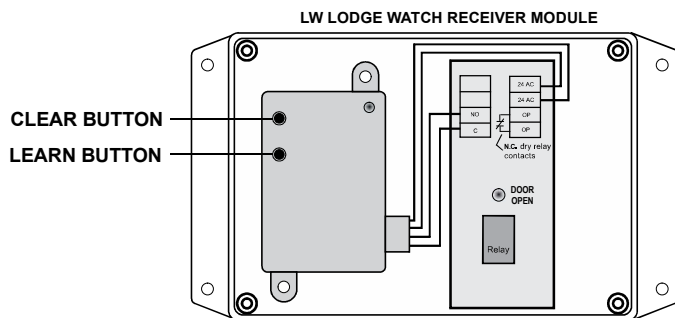

**To initiate Global Clear, use the following steps:**

1. Press and hold the CLEAR button for 3 seconds until the LED begins slowly blinking.
2. Clear mode will time out and exit in 30 seconds.
3. All linked door/window sensors and relay will be reset to factory default.