

1586A

SUPER-DAQ Precision Temperature Scanner

Users Manual

June 2013

© 2013 Fluke Corporation. All rights reserved. Specifications are subject to change without notice.

All product names are trademarks of their respective companies.

LIMITED WARRANTY AND LIMITATION OF LIABILITY

Each Fluke product is warranted to be free from defects in material and workmanship under normal use and service. The warranty period is one year and begins on the date of shipment. Parts, product repairs, and services are warranted for 90 days. This warranty extends only to the original buyer or end-user customer of a Fluke authorized reseller, and does not apply to fuses, disposable batteries, or to any product which, in Fluke's opinion, has been misused, altered, neglected, contaminated, or damaged by accident or abnormal conditions of operation or handling. Fluke warrants that software will operate substantially in accordance with its functional specifications for 90 days and that it has been properly recorded on non-defective media. Fluke does not warrant that software will be error free or operate without interruption.

Fluke authorized resellers shall extend this warranty on new and unused products to end-user customers only but have no authority to extend a greater or different warranty on behalf of Fluke. Warranty support is available only if product is purchased through a Fluke authorized sales outlet or Buyer has paid the applicable international price. Fluke reserves the right to invoice Buyer for importation costs of repair/replacement parts when product purchased in one country is submitted for repair in another country.

Fluke's warranty obligation is limited, at Fluke's option, to refund of the purchase price, free of charge repair, or replacement of a defective product which is returned to a Fluke authorized service center within the warranty period.

To obtain warranty service, contact your nearest Fluke authorized service center to obtain return authorization information, then send the product to that service center, with a description of the difficulty, postage and insurance prepaid (FOB Destination). Fluke assumes no risk for damage in transit. Following warranty repair, the product will be returned to Buyer, transportation prepaid (FOB Destination). If Fluke determines that failure was caused by neglect, misuse, contamination, alteration, accident, or abnormal condition of operation or handling, including overvoltage failures caused by use outside the product's specified rating, or normal wear and tear of mechanical components, Fluke will provide an estimate of repair costs and obtain authorization before commencing the work. Following repair, the product will be returned to the Buyer transportation prepaid and the Buyer will be billed for the repair and return transportation charges (FOB Shipping Point).

THIS WARRANTY IS BUYER'S SOLE AND EXCLUSIVE REMEDY AND IS IN LIEU OF ALL OTHER WARRANTIES, EXPRESS OR IMPLIED, INCLUDING BUT NOT LIMITED TO ANY IMPLIED WARRANTY OF MERCHANTABILITY OR FITNESS FOR A PARTICULAR PURPOSE. FLUKE SHALL NOT BE LIABLE FOR ANY SPECIAL, INDIRECT, INCIDENTAL, OR CONSEQUENTIAL DAMAGES OR LOSSES, INCLUDING LOSS OF DATA, ARISING FROM ANY CAUSE OR THEORY.

Since some countries or states do not allow limitation of the term of an implied warranty, or exclusion or limitation of incidental or consequential damages, the limitations and exclusions of this warranty may not apply to every buyer. If any provision of this Warranty is held invalid or unenforceable by a court or other decision-maker of competent jurisdiction, such holding will not affect the validity or enforceability of any other provision.

Table of Contents

| Chapter | Title | Page |
|----------|--|------------|
| 1 | Product Overview and Specifications | 1-1 |
| | Introduction..... | 1-3 |
| | Product Overview | 1-3 |
| | Front and Rear-Panel Overview..... | 1-5 |
| | Safety Information | 1-9 |
| | Screen Capture Feature..... | 1-11 |
| | About this Manual | 1-12 |
| | The Product Manual Set | 1-12 |
| | How to Contact Fluke Calibration | 1-13 |
| | Calibration and Repair Information | 1-13 |
| | General Specifications | 1-13 |
| | Measurement Specifications | 1-15 |
| | PRT/RTD..... | 1-15 |
| | PRT/RTD Resistance Accuracy | 1-15 |
| | PRT/RTD Temperature Accuracy..... | 1-16 |
| | PRT/RTD Measurement Characteristics..... | 1-16 |
| | Thermistor | 1-16 |
| | Thermistor Resistance Accuracy..... | 1-16 |
| | Thermistor Temperature Accuracy | 1-17 |
| | Thermistor Measurement Characteristics..... | 1-17 |
| | Thermocouple..... | 1-18 |
| | Thermocouple Voltage Accuracy..... | 1-18 |
| | Thermocouple Reference Junction Accuracy | 1-18 |
| | Thermocouple Temperature Accuracy..... | 1-18 |
| | Thermocouple Measurement Characteristics | 1-19 |
| | DC Voltage..... | 1-20 |
| | DC Voltage Accuracy | 1-20 |
| | DC Voltage Input Characteristics | 1-20 |
| | DC Current | 1-20 |
| | DC Current Accuracy..... | 1-20 |
| | DC Current Input Characteristics..... | 1-21 |
| | Resistance..... | 1-21 |
| | Resistance Accuracy | 1-21 |
| | Resistance Input Characteristics | 1-21 |

| | | |
|----------|---|------------|
| | Digital I/O..... | 1-22 |
| | Totalizer..... | 1-22 |
| | Trigger..... | 1-22 |
| | Alarm Output..... | 1-22 |
| | 1586-2588 DAQ-STAQ Input Module Specifications | 1-22 |
| | General | 1-22 |
| | 1586-2586 High-Capacity Input Module Specifications | 1-22 |
| | General | 1-22 |
| 2 | Initial Setup and Configuration | 2-1 |
| | Introduction..... | 2-3 |
| | Set the Regional Voltage | 2-3 |
| | Connect to Mains Power..... | 2-4 |
| | Set the Handle Position..... | 2-5 |
| | Power On and Standby | 2-6 |
| | Warm-Up the Product..... | 2-7 |
| | Configure the Product..... | 2-7 |
| | Input Module and Relay Card Installation..... | 2-8 |
| | Install a DAQ-STAQ Multiplexer Connection Module..... | 2-11 |
| | Set Up Security | 2-13 |
| 3 | Input and Channel Configuration..... | 3-1 |
| | Introduction..... | 3-3 |
| | Input Wiring..... | 3-3 |
| | The 1586-2586 High Capacity Input Module..... | 3-3 |
| | The 1586-2588 DAQ-STAQ Multiplexer Connector Module | 3-4 |
| | Wiring Safety and Considerations..... | 3-5 |
| | 3-Wire and 4-Wire Sense Input Configuration..... | 3-6 |
| | Input Types and Wiring Diagrams | 3-7 |
| | Input Wiring Instructions | 3-8 |
| | Channel Configuration..... | 3-10 |
| | About Channel Numbers | 3-10 |
| | Basic Channel Operations | 3-12 |
| | Open the Channel Setup Menu | 3-12 |
| | Set Channels to ON or OFF | 3-13 |
| | Verify a Channel | 3-14 |
| | Zero a Channel | 3-14 |
| | Copy a Channel | 3-15 |
| | Save or Load a Channel Configuration (Setup File)..... | 3-16 |
| | Reset the Channel and Test Configuration..... | 3-18 |
| | Analog Channel Configuration (Ch001, Ch101 to Ch222)..... | 3-18 |
| | Current and Voltage Channels | 3-19 |
| | Resistance Channels..... | 3-20 |
| | Thermocouple Channels..... | 3-21 |
| | Thermistor Channels | 3-22 |
| | PRT Channels..... | 3-23 |
| | Digital I/O (DIO) Channel Configuration (Ch401)..... | 3-24 |
| | Totalizer Channel Configuration (Ch402)..... | 3-25 |
| | Read Mode | 3-25 |
| | Debounce | 3-25 |
| | Math Channel Configuration (Ch501 to Ch520)..... | 3-27 |
| | Mx+B, Alarms, and Channel Options..... | 3-30 |
| | Mx+B Scaling..... | 3-30 |
| | HI and LO Channel Alarms..... | 3-31 |

| | | |
|----------|---|------------|
| | Channel Delay | 3-33 |
| | Rate of Change | 3-33 |
| | Display As | 3-34 |
| | Open Detect | 3-34 |
| | Probe Library | 3-34 |
| 4 | Scan/Monitor, Record, and Data | 4-1 |
| | Introduction..... | 4-3 |
| | Scan..... | 4-3 |
| | About Scan Timing and Sampling..... | 4-5 |
| | Configure a Scan | 4-6 |
| | Trigger Type..... | 4-7 |
| | Auto Recording | 4-8 |
| | File Destination | 4-8 |
| | Sample Rate | 4-8 |
| | Data Security..... | 4-9 |
| | Temperature Unit | 4-10 |
| | Align Channels..... | 4-10 |
| | Automatic Power Loss Scan Resume..... | 4-11 |
| | Basic Scan Procedures..... | 4-11 |
| | Start a Scan..... | 4-11 |
| | View Scan Data and Statistics..... | 4-12 |
| | Graph the Measurements..... | 4-14 |
| | Monitor | 4-15 |
| | Automated Test..... | 4-16 |
| | Overview | 4-16 |
| | Configure an Automated Test..... | 4-17 |
| | Connect to An External Source | 4-18 |
| | Record..... | 4-19 |
| | Record Measurement Data | 4-19 |
| | Memory Consumption for Recorded Data | 4-20 |
| | Open and View Measurement Data on a PC | 4-20 |
| | How to Read the Setup CSV File..... | 4-22 |
| | How to Read the Data CSV File..... | 4-24 |
| 5 | Measure/DMM Operation | 5-1 |
| | Introduction..... | 5-3 |
| | About the Measure Function..... | 5-3 |
| | About the DMM Function | 5-3 |
| | Input Type Selection and Range Adjustment | 5-4 |
| | Relative Measurements..... | 5-4 |
| | Graph the Measurements | 5-5 |
| | Measurement Statistics | 5-6 |
| 6 | Maintenance and Care | 6-1 |
| | Introduction..... | 6-3 |
| | Clean the Product..... | 6-3 |
| | Replace the Fuse | 6-3 |
| | Memory Reset and Factory Reset | 6-4 |
| | User-Replaceable Parts and Accessories | 6-5 |
| 7 | Error Messages and Troubleshooting..... | 7-1 |
| | Introduction..... | 7-3 |

| | |
|-----------------------|------|
| Error Messages | 7-3 |
| Troubleshooting | 7-20 |

List of Tables

| Table | Title | Page |
|-------|--|------|
| 1-1. | Front-Panel Features | 1-5 |
| 1-2. | Rear-Panel Features | 1-7 |
| 1-3. | Symbols..... | 1-9 |
| 2-1. | Fuses..... | 2-3 |
| 2-2. | Instrument Setup Menu | 2-7 |
| 3-1. | Types of Inputs..... | 3-8 |
| 3-2. | Channel Types and Numbers | 3-10 |
| 3-3. | Channel Setup Menu | 3-12 |
| 3-4. | Current and Voltage Channel Configuration..... | 3-19 |
| 3-5. | Resistance Channel Configuration | 3-20 |
| 3-6. | Thermocouple Channel Configuration..... | 3-21 |
| 3-7. | Thermistor Channel Setup..... | 3-22 |
| 3-8. | PRT Channel Setup | 3-23 |
| 3-9. | Totalizer Channel Configuration..... | 3-26 |
| 3-10. | Math Channel Formulas | 3-27 |
| 3-11. | Math Channel Configuration..... | 3-29 |
| 4-1. | The Scan Menu | 4-4 |
| 4-2. | Scan Sample Rates | 4-9 |
| 4-3. | Scan Statistics..... | 4-13 |
| 4-4. | Automated Test Setup | 4-17 |
| 4-5. | Scan Data Memory Usage..... | 4-20 |
| 5-1. | Statistics | 5-6 |
| 6-1. | Fuses..... | 6-3 |
| 6-2. | Comparison of the Memory Clear Functions..... | 6-4 |
| 6-3. | User-Replaceable Parts and Accessories..... | 6-5 |
| 7-1. | Error Messages..... | 7-3 |
| 7-2. | Troubleshooting Chart..... | 7-20 |

List of Figures

| Figure | Title | Page |
|--------|---|------|
| 1-1. | Screen Capture | 1-11 |
| 2-1. | Fuse Replacement and Line-Voltage Selection..... | 2-3 |
| 2-2. | Mains Power Cord Connection | 2-4 |
| 2-3. | Handle Positions and Boot Removal..... | 2-5 |
| 2-4. | Main Power Switch and Standby Key..... | 2-6 |
| 2-5. | Module Indicator Example..... | 2-9 |
| 2-6. | Relay Card Installation..... | 2-10 |
| 2-7. | DAQ-STAQ Multiplexer Installation..... | 2-12 |
| 3-1. | 2-Wire, 3-Wire, and 4-Wire Input Module Connections | 3-3 |
| 3-2. | 2-Wire, 3-Wire, and 4-Wire Multiplexer Connections | 3-4 |
| 3-3. | 3-Wire and 4-Wire Channel Reservation | 3-7 |
| 3-4. | Module Indicator (Input Module Installed Shown)..... | 3-9 |
| 3-5. | Example Channel Assignment | 3-11 |
| 3-6. | Channel Status Indicators..... | 3-13 |
| 3-7. | Zero Function | 3-15 |
| 3-8. | DIO Connector | 3-24 |
| 3-9. | Totalizer Input (TOT) | 3-25 |
| 3-10. | Rear-Panel Alarm Outputs | 3-32 |
| 3-11. | Alarm Output Example | 3-32 |
| 3-12. | The Probe Library | 3-34 |
| 4-1. | Scan Data | 4-4 |
| 4-2. | Illustration of a Scan Sweep..... | 4-6 |
| 4-3. | Test Setup Menu Example | 4-7 |
| 4-4. | Scan Data | 4-13 |
| 4-5. | Graph Feature..... | 4-14 |
| 4-6. | Monitor Menu | 4-15 |
| 4-7. | External Temperature Control Source..... | 4-16 |
| 4-8. | Scan Data File Name Convention | 4-21 |
| 4-9. | Setup.csv and Dat00001.csv Files..... | 4-22 |
| 5-1. | Example Voltage Front-Panel Connection..... | 5-3 |
| 5-2. | Input Function Selection | 5-4 |
| 5-3. | Relative Measurement..... | 5-5 |
| 5-4. | Graph Function..... | 5-5 |
| 5-5. | DMM Statistics | 5-6 |
| 6-1. | Fuse Replacement | 6-4 |

Chapter 1

Product Overview and Specifications

| Title | Page |
|--|------|
| Introduction..... | 1-3 |
| Product Overview | 1-3 |
| Front and Rear-Panel Overview..... | 1-5 |
| Safety Information | 1-9 |
| Screen Capture Feature..... | 1-11 |
| About this Manual | 1-12 |
| The Product Manual Set | 1-12 |
| How to Contact Fluke Calibration | 1-13 |
| Calibration and Repair Information..... | 1-13 |
| General Specifications | 1-13 |
| Measurement Specifications | 1-15 |
| PRT/RTD..... | 1-15 |
| PRT/RTD Resistance Accuracy | 1-15 |
| PRT/RTD Temperature Accuracy..... | 1-16 |
| PRT/RTD Measurement Characteristics..... | 1-16 |
| Thermistor | 1-16 |
| Thermistor Resistance Accuracy..... | 1-16 |
| Thermistor Temperature Accuracy | 1-17 |
| Thermistor Measurement Characteristics..... | 1-17 |
| Thermocouple..... | 1-18 |
| Thermocouple Voltage Accuracy..... | 1-18 |
| Thermocouple Reference Junction Accuracy | 1-18 |
| Thermocouple Temperature Accuracy..... | 1-18 |
| Thermocouple Measurement Characteristics | 1-19 |
| DC Voltage..... | 1-20 |
| DC Voltage Accuracy | 1-20 |
| DC Voltage Input Characteristics | 1-20 |
| DC Current | 1-20 |
| DC Current Accuracy..... | 1-20 |
| DC Current Input Characteristics..... | 1-21 |
| Resistance..... | 1-21 |
| Resistance Accuracy | 1-21 |
| Resistance Input Characteristics | 1-21 |
| Digital I/O..... | 1-22 |
| Totalizer..... | 1-22 |
| Trigger..... | 1-22 |
| Alarm Output..... | 1-22 |
| 1586-2588 DAQ-STAQ Input Module Specifications | 1-22 |

| | |
|---|------|
| General | 1-22 |
| 1586-2586 High-Capacity Input Module Specifications | 1-22 |
| General | 1-22 |

Introduction

This chapter supplies information about the Product, the manual set, safety information, contact information, and specifications.

Product Overview

The Fluke Calibration 1586A SUPER-DAQ Precision Temperature Scanner (the Product or Instrument) is a 45 analog channel bench-top measurement instrument that measures and records temperature, resistance, dc volts, and dc current (see Table 1-1). See the Specifications section for information on the types and ranges of the measurement inputs the Product can accept.

Features of the Product include:

- **Temperature Accuracy** – Measures temperature with uncertainty as low as 0.01 °C with a PRT, 0.003 °C with a thermistor, or 0.2 °C with a thermocouple. PRT accuracy is enhanced by 4-wire sensing that cancels out lead-wire resistance, bidirectional source current that cancels thermoelectric EMF in the PRT, and ITS-90 characterization that accurately relates resistance to temperature.
- **Scan** – Sequentially scan up to 45 analog channels per scan sweep. In addition, the Product also has 20 math channels, one DIO channel, and one TOT channel that can be included in scan. A scan can be manually controlled from the front panel or triggered with a variety of triggers such a timer, an alarm, an external source, or a remote SCPI command.

While a scan is in progress, all channel values can be viewed on the display in a spreadsheet format along with statistics such as average, standard deviation, minimum, maximum, peak-to-peak, and rate-of-change. With the Graph feature, channel measurement data for up to four channels can be plotted and viewed on the display. Users can toggle the data mode with a softkey to view live data or historical data.

- **Monitor** – View the measurement value or the statistics of a single channel. Monitor is an independent feature that can be used while a scan is in progress or inactive. Much like the Scan feature, the statistics of the single measurement can be viewed on the display or be shown in a graph.
- **Digital Multimeter Functionality (DMM)** – Function that presents the user with familiar DMM features and controls like a standard bench DMM. The DMM can show 6 ½ digits on the display. To visualize trend data, the DMM provides additional functionality to graph and see measurement statistics.

- **Data Storage** - Store up to 20 MB of data and channel setup files directly to the internal non-volatile memory or an external USB drive. Data can also be transferred to a PC with a USB drive or LAN TCP/IP interface at the rear of the unit with SCPI interface command sets.
- **Alarms** – Each channel can be assigned two independent alarms to indicate when either an upper (HI) or lower (LO) range has been exceeded. The alarms can be configured to output a digital signal from the rear-panel alarm output for control of external devices.
- **Digital I/O (DIO)** – The Product is equipped with a digital 8-bit transistor-transistor logic (TTL) port that can sense and output. When the DIO channel is included in the scan list, the value of this port is recorded in the scan data record on each scan with a value range of 0 to 255 based on the port state when it is read.
- **Totalizer** – The Product is equipped with a unidirectional, resettable totalizer with an input count capability of 1,048,575 (20 bits). Counter increment is accomplished through a change to a digital signal or contact closure to the totalizer input terminals on the rear of the Instrument.
- **Remote Operation** – Remotely operate the Product with remote SCPI commands from application software over a rear-panel USB or LAN TCP/IP connection.
- **Automated Sensor Test** – Automatically sets the temperature of a Fluke Calibration dry-well calibrator or temperature bath connected to the rear-panel RS-232 port. Monitors temperature stability, and measures the readings of temperature sensors and a reference thermometer when the temperature is stable.
- **DAQ-STAQ Accessory** – Multiplexer module provides quick and convenient connection of temperature sensors with Fluke's patented spring-loaded DWF terminals.

Front and Rear-Panel Overview

Table 1-1 identifies and describes the front-panel features and Table 1-2 identifies and describes the rear-panel features.

Table 1-1. Front-Panel Features

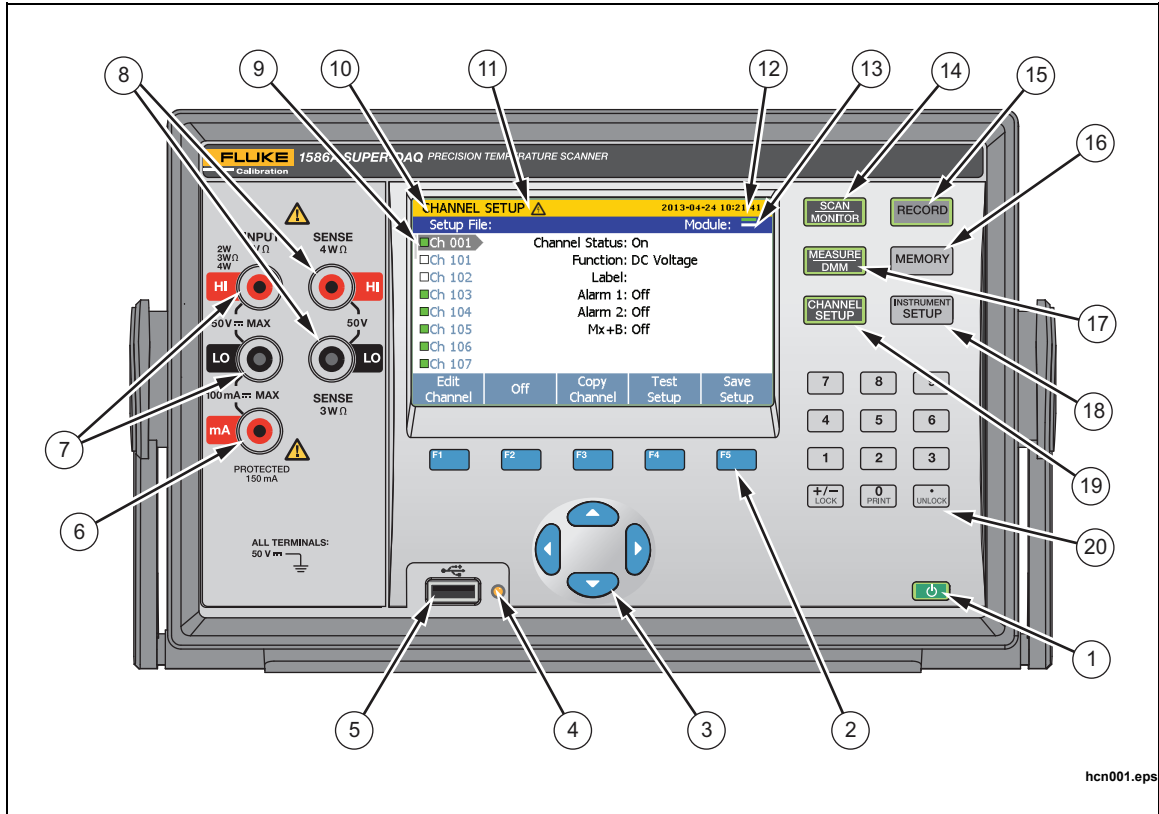

hcn001.eps

| Item | Name | Function |
|------|-------------------|---|
| ① | Standby Key | Puts the Product in the standby mode. In standby, the display is off and the keys are disabled. Standby mode also disables remote operation. See “Power ON and Standby” in Chapter 2. |
| ② | Function Softkeys | Function softkeys to open submenus and set selections. The function of the softkey changes with each menu and is shown above the softkey on the display. |
| ③ | Arrow Keys | Scroll menus, increase or decrease values, and highlight selections. The keys also let the user cycle through measurement values in data menus and also change the view of graphs. |

Table 1-1. Front-Panel Features (cont.)

| Item | Name | Function |
|------|---|---|
| ④ | USB Data Transfer Indicator | Red LED that illuminates when the USB drive is recognized and flashes red when data is transferred to or from the USB drive. ⚠ Caution To prevent data loss, do not remove the USB drive when the LED is flashing. |
| ⑤ | Front-Panel USB Port | USB port to insert a USB drive. |
| ⑥ | Current Input Terminal | Input terminal to make current measurements up to 100 mA. The current input is connected to a thermal over-current protection circuit that disconnects the input when an overcurrent occurs and reconnects the input when the condition is removed. |
| ⑦ | V, Ω , mA Input Terminals | Input terminals that connect to test leads to measure dc volts, dc milliamps, resistance, and temperature. |
| ⑧ | 4W Ω Sense Terminals | Sense input terminals to make 3-wire and 4-wire compensated resistance measurements. |
| ⑨ | Channel Status Indicator | Square green box that shows when a channel is set to ON. When a channel is set to ON, it is referred to as "active". |
| ⑩ | Menu Name | Name of the menu. |
| ⑪ |  Hazardous Voltage Indicator | Warns the user of hazardous voltage on an input. Shows when voltage is >30 V dc. |
| ⑫ | Date and Time | Shows the current date and time that is set in the Instrument Setup menu. This date and time is used for timestamps when data is logged. |
| ⑬ | Module Indicator | Visually shows how many and which slots the Input Modules are connected to. See "Input Module and Relay Card Installation" in Chapter 2. |
| ⑭ | Scan/Monitor | Scan all active channels. The Scan function samples all active channels directed by the test setup file. The Monitor function shows measurement data of a single channel. See Chapter 4 for more information and operation instructions. |

Table 1-1. Front-Panel Features (cont.)

| Item | Name | Function |
|------|------------------|---|
| ⑮ | Record | Starts and stops data recording. When recording, the key illuminates and “RECORDING” shows on the top of the display. Recording can be set to automatically start and stop with a scan. In addition to recording scan data, measurements made with the front-panel DMM can also be recorded. See Chapter 4 for more information and operation instructions. |
| ⑯ | Memory | Manage setup files, scan data files, and DMM data files on either the internal memory or USB drive. |
| ⑰ | Measure/DMM | Operate the single-channel measurement function or digital multimeter (DMM) function that lets the user quickly configure and make measurements with the front-panel inputs. See Chapter 5 for DMM operation instructions. |
| ⑱ | Instrument Setup | Configure the Product. Menu contains many user-configurable settings to customize the Product. See “Configure the Product” in Chapter 2. |
| ⑲ | Channel Setup | Configure and verify channels. Channel Setup is the default menu that shows on the display when the Product is powered on. See Chapter 3 for instructions on how to wire and configure a channel. |
| ⑳ | Numeric Keypad | Use to input numerical values when prompted. Push and hold the PRINT or “0” key to take a screenshot of the display. Push and hold the LOCK key to lock the front panel to prevent changes and UNLOCK to unlock. |

Table 1-2. Rear-Panel Features

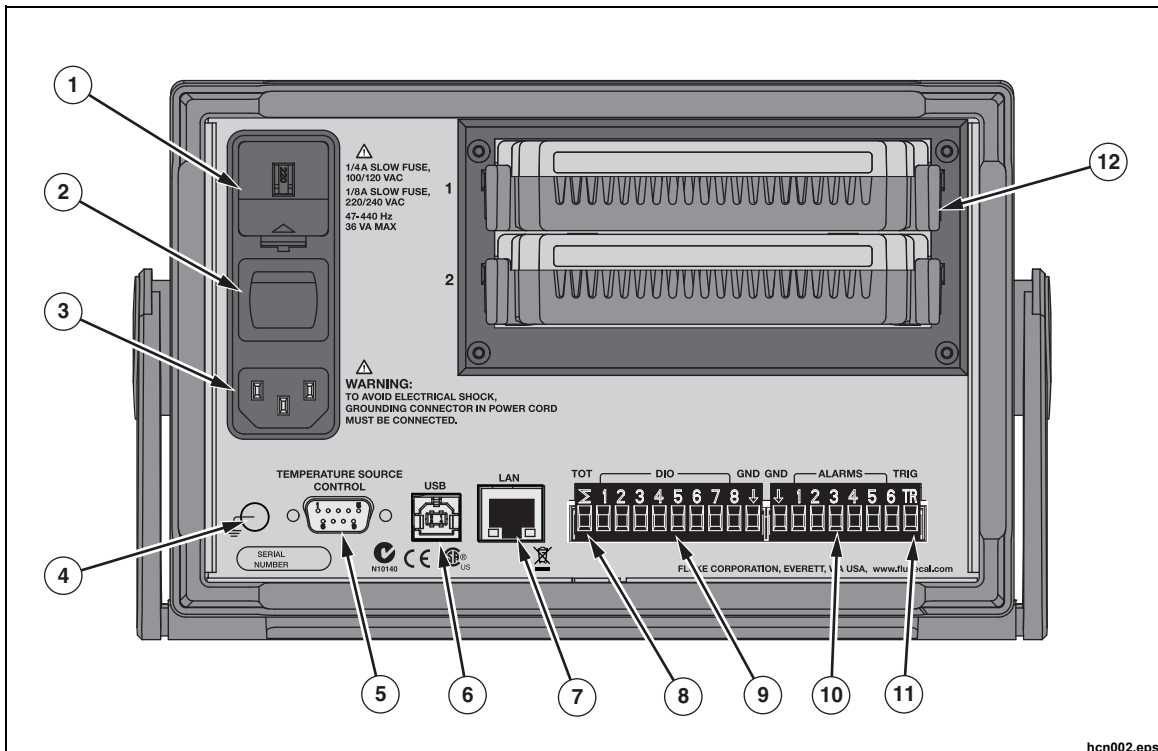

| Item | Name | Function |
|------|--------------------------------|---|
| ① | Line Voltage Selector and Fuse | Regional voltage selector. See “Set the Regional Voltage” in Chapter 2. |

Table 1-2. Rear-Panel Features (cont.)











| Item | Name | Function |
|------|--|---|
| ② | Main Power Switch | Supplies and disconnects mains power to the unit. |
| ③ | Mains Power Connector | Mains power cord receptacle. |
| ④ | Chassis Ground | Terminal that is internally grounded to the chassis. If the Product is the location of the ground reference point in a system, this binding post can be used to connect other instruments to earth ground. |
| ⑤ | Temperature Source Control | RS-232 connector used to control a Fluke Calibration dry-well or temperature bath for automated tests on temperature instruments. See “Automated Test” in Chapter 4. |
| ⑥ | Serial USB Port | USB port used for remote operation. See the <i>1586A Remote Programmers Guide</i> . |
| ⑦ | LAN Connection | Network port used for remote operation. See the <i>1586A Remote Programmers Guide</i> . |
| ⑧ | Totalizer Input | Input terminal for the Totalizer feature. See “Totalizer Channel Configuration” in Chapter 3. |
| ⑨ | DIO (Digital I/O Input Ports) | Eight digital ports used to sense and output a digital, 8-bit transistor-transistor logic (TTL) value that can be displayed as the 8-bit TTL value and be recorded as the decimal equivalent. |
| ⑩ | Digital External Alarm Trigger Outputs | Six digital outputs that can be used to trigger a digital external alarm if a channel exceeds the set alarm limits. See “HI and LO Channel Alarms” in Chapter 3. |
| ⑪ | Trigger Input | Input terminal to trigger a scan when the External trigger type is used. See “Scan Test Setup” in Chapter 4. |
| ⑫ | Input Module Slots | Slots that accept up to two High-Capacity Input Modules or DAQ-STAQ Multiplexer Connection Modules. See “Input Module and Relay Card Installation” and “Install a DAQ-STAQ Multiplexer Connection Module” in Chapter 2. |

Safety Information

A **Warning** identifies conditions and procedures that are dangerous to the user. A **Caution** identifies conditions and procedures that can cause damage to the Product or the equipment under test.

See Table 1-3 for a list of symbols used in this manual and on the Product.

Table 1-3. Symbols

| Symbol | Description | Symbol | Description |
|--|--|---|--|
|  | Risk of danger. Important information. See manual. |  | DC (Direct Current) |
|  | Hazardous voltage. Voltage >30 V dc or ac peak might be present. |  | AC or DC (Alternating or Direct Current) |
|  | Earth ground. |  | Digital signal. |
|  | Recycle. |  | Power ON / OFF |
| CAT II ^[1] | Measurement Category II is applicable to test and measuring circuits connected directly to utilization points (socket outlets and similar points) of the low-voltage MAINS installation. | | |
| CAT III ^[1] | Measurement Category III is applicable to test and measuring circuits connected to the distribution part of the building's low-voltage MAINS installation. | | |
| CAT IV ^[1] | Measurement Category IV is applicable to test and measuring circuits connected at the source of the building's low-voltage MAINS installation. | | |
|  | This product complies with the WEEE Directive (2002/96/EC) marking requirements. The affixed label indicates that you must not discard this electrical/electronic product in domestic household waste. Product Category: With reference to the equipment types in the WEEE Directive Annex I, this product is classed as category 9 "Monitoring and Control Instrumentation" product. Do not dispose of this product as unsorted municipal waste. Go to Fluke's website for recycling information. | | |
|  | Product conforms with the requirements of the applicable EC directives. | | |
| Note: | | | |
| [1] - This equipment is not intended for measurements in CAT II, CAT III, or CAT IV environments. These definitions are included because the test leads supplied with the product include these ratings. | | | |

Warning

To prevent possible electrical shock, fire, or personal injury:

- Read all safety information before you use the Product.
- Carefully read all instructions.

- Use the Product only as specified, or the protection supplied by the Product can be compromised.
- Examine the case before you use the Product. Look for cracks or missing plastic. Carefully look at the insulation around the terminals.
- Do not use the Product if it operates incorrectly.
- Do not use and disable the Product if it is damaged.
- Use only the mains power cord and connector approved for the voltage and plug configuration in your country and rated for the Product.
- Replace the mains power cord if the insulation is damaged or if the insulation shows signs of wear.
- Make sure the ground conductor in the mains power cord is connected to a protective earth ground. Disruption of the protective earth could put voltage on the chassis that could cause death.
- Do not put the Product where access to the mains power cord is blocked.
- Use only correct measurement category (CAT), voltage, and amperage rated probes, test leads, and adapters for the measurement.
- Use only cables with correct voltage ratings.
- Do not use test leads if they are damaged. Examine the test leads for damaged insulation and measure a known voltage.
- Do not exceed the Measurement Category (CAT) rating of the lowest rated individual component of a Product, probe, or accessory.
- Keep fingers behind the finger guards on the probes.
- Do not apply more than the rated voltage, between the terminals or between each terminal and earth ground.
- Do not touch voltages >30 V ac rms, 42 V ac peak, or 60 V dc.
- Limit operation to the specified measurement category, voltage, or amperage ratings.
- Measure a known voltage first to make sure that the Product operates correctly.

- Consider all accessible channels to be hazardous live and an electric shock hazard if any channel is connected to a hazardous voltage source.
- Do not remove, touch, or change the internal wiring of hazardous inputs until the input source is turned off.
- Remove inputs from hazardous voltage sources before an input module is opened.
- Use the correct terminals, function, and range for measurements.
- Use this Product indoors only.
- Do not use the Product around explosive gas, vapor, or in damp or wet environments.

Screen Capture Feature

The Product can take a screenshot of the display and save it directly to the USB drive.

To take a screenshot of the display (see Figure 1-1):

1. Insert a USB drive in the front panel and wait for the USB Data Transfer Indicator to show solid red.
2. Push and hold the PRINT or “0” key on the numeric keypad for 3 seconds and then release. The display shows “File Saved”.
3. Remove the USB from the front panel and connect it to a USB drive on a PC.
4. Open the USB drive and navigate to the image folder with this path:

`\\fluke\1586A\[Product Serial Number]\Image`

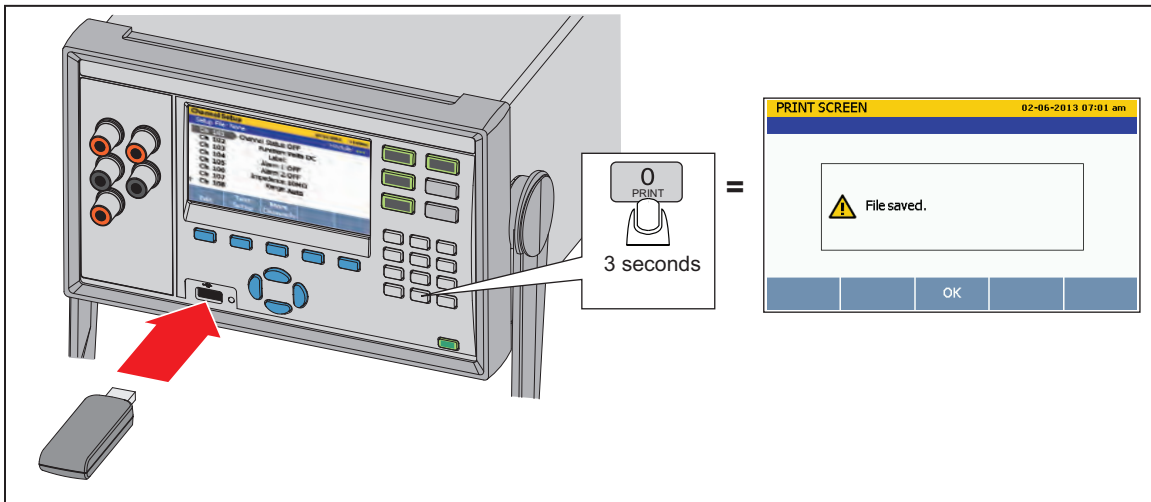

Figure 1-1. Screen Capture

hcn024.eps

About this Manual

This manual has seven chapters:

- **Chapter 1** supplies product information, safety information, contact information, and product specifications.
- **Chapter 2** supplies information and instructions on how to set up and configure the Product for first time use.
- **Chapter 3** supplies instructions on how to wire inputs to the Input Module then configure the associated channel.
- **Chapter 4** supplies information and instructions on how to do a scan, monitor a channel, and record measurement data.
- **Chapter 5** supplies instructions on how to operate the DMM function of the Product.
- **Chapter 6** supplies information on how to clean the Product and replace the fuse in the rear of the Product.
- **Chapter 7** supplies information on error messages and how to troubleshoot the Product.

The Product Manual Set

The Product manual set includes:

- This *1586A Users Manual* that contains feature information, operation instructions, and basic user maintenance and troubleshooting information. The Users Manual is translated into many languages.
- The *1586A Safety Information* is printed and contains important safety information for this Product. The Safety Information is translated into many languages.
- The *1586A Remote Programmers Guide* contains information on how to remotely operate the Product. The Programmers Guide alphabetically lists all commands and provides example code for different applications.
- The *1586A Calibration Manual* contains calibration and adjustment procedures to keep the Product within specifications.
- The *1586A Product CD* contains the all the manuals in the manual set.

General Specifications

Mains Voltage

| | |
|---------------------|----------------|
| 100 V Setting | 90 V to 110 V |
| 120 V Setting | 108 V to 132 V |
| 220 V Setting | 198 V to 242 V |
| 240 V Setting | 216 V to 264 V |

Frequency 47 Hz to 440 Hz

Power Consumption 36 VA peak (24 W average)

Environment Temperature

| | |
|--------------------|--|
| Operating | 0 °C to 50 °C |
| Full accuracy..... | 18 °C to 28 °C |
| Storage | -20 °C to 70 °C |
| Warm-up..... | 1 hour to full accuracy specifications |

Relative Humidity (non-condensing)

| | |
|-----------------|-----------------------|
| Operating | 0 °C to 30 °C <80 % |
| | 30 °C to 50 °C <50 % |
| Storage | -20 °C to 70 °C <95 % |

| | |
|-----------------------------------|--|
| Altitude | |
| Operating | 2,000 m |
| Storage | 12,000 m |
| Vibration and Shock | Complies with MIL-PRF-28800F Class 3 |
| Channel Capacity | |
| Total analog channels | 45 |
| Voltage/resistance channels | 41 |
| Current channels | 5 |
| Digital I/O | 8 bits |
| Totalizer | 1 |
| Alarm outputs | 6 |
| Trigger input | 1 |
| Input Protection | 50 V all functions, terminals and ranges |
| Math Channels | |
| Number of channels | 20 |
| Operations | sum, difference, multiply, divide, polynomial, power, square root, reciprocal, exponential, logarithm, absolute value, average, maximum, minimum |
| Triggers | interval, external (trigger input), alarm, remote (bus), manual, automated test |
| Memory | |
| Scan data RAM | 75,000 readings with timestamp |
| Data/Setup flash memory | 20 MB |
| USB Host Port | |
| Connector type | Type A |
| Function | Memory |
| File system | FAT32 |
| Memory capacity | 32 GB |
| USB Device Port | |
| Connector type | Type B |
| Class | Instrument |
| Function | Control and data transfer |
| Command protocol | SCPI |
| LAN | |
| Function | Control and data transfer |
| Network protocols | Ethernet 10/100, TCP/IP |
| Command protocol | SCPI |
| RS-232 | |
| Connector | D-sub 9 pin (DE-9) |
| Baud rates | 1200, 2400, 4800, 9600, 19200, 38400 |
| Function | Temperature source control output |
| Dimensions | |
| Height | 150 mm |
| Width | 245 mm |
| Depth | 385 mm |
| Weight | 6 kg (typical configuration) |
| Shipping Weight | 9.5 kg (typical configuration) |
| Conformity | CE, CSA, IEC 61010 3 rd ed. |

Measurement Specifications

Accuracy specifications generally apply with medium and slow sample rates (unless otherwise noted), after a warm-up time of 1 hour, and within an environment temperature range of 18 °C to 28 °C, and may depend on the channel. The confidence level for accuracy specifications is 95 % within 1 year of calibration.

Scan rate

Fast..... 10 channels per second max (0.1 seconds per channel)
 Medium 1 channel per second (1 second per channel)
 Slow 4 seconds per channel

Display Resolution..... 4 ½ to 6 ½ digits, depending on function and Sample Rate (see Measurement Characteristics tables below to find the display resolution of temperature readings)

PRT/RTD

Temperature Range -200 °C to 1200 °C (depending on the sensor)

Resistance Range 0 Ω to 4 kΩ

Offset Compensation

0 Ω to 400 Ω, 4-wire..... automatic current reversal
 400 Ω to 4000 Ω or 3-wire none

Source Current Reversal Interval (0 Ω to 400 Ω range)

Fast sample rate 2 ms
 Medium sample rate 250 ms
 Slow sample rate 250 ms

Maximum Lead Resistance (4-wire Ω) 2.5 % of range per lead for 400 Ω and 4 kΩ ranges.

PRT/RTD Resistance Accuracy

Accuracy is given as ± (% of measurement + ohms). Basic accuracy is for 4-wire PRT/RTD using medium or slow sample rate. When using 3-wire PRT/RTD add 0.013 Ω to the accuracy specification for internal resistance mismatch and voltage offset if using Channel 1, or add 0.05 Ω if using channels x01 through x20. When using Fast sample rate add the number given in the table to the accuracy specification. The 4 kΩ range accuracy specification can be decreased by 0.06 Ω if using Slow sample rate. If the environment temperature is outside the specified range, multiply the temperature coefficient numbers by the temperature deviation and add to the accuracy specification.

| Range | DAQ-STAQ Module | High-Capacity Module | Fast Sample Rate | T.C./ °C Outside 18 °C to 28 °C |
|---------------|-------------------|----------------------|------------------|---------------------------------|
| 0 Ω to 400 Ω | 0.002 % + 0.002 Ω | 0.003 % + 0.003 Ω | add 0.003 Ω | 0.0001 % + 0.0008 Ω |
| 400 Ω to 4 kΩ | 0.004 % + 0.1 Ω | 0.006 % + 0.1 Ω | add 0.08 Ω | 0.0001 % + 0.008 Ω |

PRT/RTD Temperature Accuracy

Accuracy is for 4-wire 100 Ω nominal PRT/RTD, using medium or slow sample rate. When using 3-wire PRT/RTD add 0.039 °C to the accuracy specification for internal resistance mismatch and voltage offset if using Channel 1, or add 0.15 °C if using channels x01 through x20. When using the Fast sample rate, add the number given in the table to the accuracy specification. If the environment temperature is outside the specified range, multiply the temperature coefficient number by the temperature deviation and add to the accuracy specification. Linear interpolation may be used between points in the table. Specifications do not include sensor accuracy. The practical range of temperature measurement depends on the sensor and characterization.

| Temperature | DAQ-STAQ Module | High-Capacity Module | Fast Sample Rate | T.C./ °C Outside 18 °C to 28 °C |
|-------------|-----------------|----------------------|------------------|---------------------------------|
| -200 °C | 0.006 °C | 0.01 °C | add 0.01 °C | 0.0019 °C |
| 0 °C | 0.01 °C | 0.015 °C | add 0.01 °C | 0.0023 °C |
| 300 °C | 0.018 °C | 0.03 °C | add 0.01 °C | 0.0028 °C |
| 600 °C | 0.026 °C | 0.045 °C | add 0.01 °C | 0.0034 °C |

PRT/RTD Measurement Characteristics

| Range | Temperature Display Resolution | | Source Current |
|---------------|--------------------------------|------------------|----------------|
| | Slow / Medium Sample Rate | Fast Sample Rate | |
| 0 Ω to 400 Ω | 0.001 °C | 0.01 °C | ±1 mA |
| 400 Ω to 4 kΩ | 0.001 °C | 0.01 °C | 0.1 mA |

Thermistor

Temperature Range -200 °C to 400 °C (depending on the sensor)

Resistance Range 0 Ω to 1 MΩ

Thermistor Resistance Accuracy

Accuracy is given as ± (% of measurement + Ω). The basic accuracy specification is for 4-wire thermistor, slow sample rate. When using medium or fast sample rate, add the number given in the table to the accuracy specification. If the environment temperature is outside the specified range, multiply the temperature coefficient numbers by the temperature deviation and add to the accuracy specification. For 2-wire thermistor add 0.02 Ω internal resistance if using Channel 1 or 1.5 Ω if using channels x01 through x20, and add external lead wire resistance.

| Range | Slow Sample Rate | Medium Sample Rate Rate | Fast Sample Rate | T.C./ °C Outside 18 °C to 28 °C |
|-----------------|------------------|-------------------------|------------------|---------------------------------|
| 0 Ω to 2.2 kΩ | 0.004 % + 0.2 Ω | add 0.3 Ω | add 1 Ω | 0.0005 % + 0.05 Ω |
| 2.1 kΩ to 98 kΩ | 0.004 % + 0.5 Ω | add 0.5 Ω | add 1.3 Ω | 0.0005 % + 0.1 Ω |
| 95 kΩ to 1 MΩ | 0.015 % + 5 Ω | add 5 Ω | add 13 Ω | 0.001 % + 2 Ω |

Thermistor Temperature Accuracy

Accuracy specifications are for 4-wire thermistor. When using 2-wire thermistor, add the number given in the table to the specification for internal resistance. If the environment temperature is outside the specified range, increase the accuracy specification by 25 % for every 1 °C outside the specified environment temperature range. Specifications do not include sensor accuracy. The practical range of temperature measurement depends on the sensor.

| Temperature | Accuracy 2.2 kΩ Thermistor | | | |
|-------------|----------------------------|--------------------|------------------|--------------|
| | Slow Sample Rate | Medium Sample Rate | Fast Sample Rate | 2-wire |
| -40 °C | 0.001 °C | 0.001 °C | 0.01 °C | add 0.001 °C |
| 0 °C | 0.003 °C | 0.004 °C | 0.01 °C | add 0.004 °C |
| 25 °C | 0.006 °C | 0.011 °C | 0.02 °C | add 0.016 °C |
| 50 °C | 0.008 °C | 0.018 °C | 0.04 °C | add 0.05 °C |
| 100 °C | 0.047 °C | 0.114 °C | 0.28 °C | add 0.34 °C |
| 150 °C | 0.23 °C | 0.56 °C | 1.34 °C | add 1.7 °C |

| Temperature | Accuracy 5 kΩ Thermistor | | | |
|-------------|--------------------------|--------------------|------------------|--------------|
| | Slow Sample Rate | Medium Sample Rate | Fast Sample Rate | 2-wire |
| -40 °C | 0.003 °C | 0.004 °C | 0.01 °C | add 0.001 °C |
| 0 °C | 0.002 °C | 0.002 °C | 0.01 °C | add 0.002 °C |
| 25 °C | 0.004 °C | 0.006 °C | 0.01 °C | add 0.007 °C |
| 50 °C | 0.005 °C | 0.009 °C | 0.02 °C | add 0.022 °C |
| 100 °C | 0.022 °C | 0.052 °C | 0.13 °C | add 0.16 °C |
| 150 °C | 0.096 °C | 0.24 °C | 0.57 °C | add 0.7 °C |

| Temperature | Accuracy 10 kΩ Thermistor | | | |
|-------------|---------------------------|--------------------|------------------|--------------|
| | Slow Sample Rate | Medium Sample Rate | Fast Sample Rate | 2-wire |
| -40 °C | 0.003 °C | 0.004 °C | 0.01 °C | add 0.001 °C |
| 0 °C | 0.002 °C | 0.002 °C | 0.01 °C | add 0.002 °C |
| 25 °C | 0.003 °C | 0.004 °C | 0.01 °C | add 0.004 °C |
| 50 °C | 0.005 °C | 0.009 °C | 0.02 °C | add 0.011 °C |
| 100 °C | 0.011 °C | 0.024 °C | 0.06 °C | add 0.067 °C |
| 150 °C | 0.04 °C | 0.098 °C | 0.24 °C | add 0.29 °C |

Thermistor Measurement Characteristics

| Range | Temperature Display Resolution | | Source Current |
|-----------------|--------------------------------|------------------|----------------|
| | Slow / Medium Sample Rate | Fast Sample Rate | |
| 0 Ω to 2.2 kΩ | 0.0001 °C | 0.001 °C | 10 μA |
| 2.1 kΩ to 98 kΩ | 0.0001 °C | 0.001 °C | 10 μA |
| 95 kΩ to 1 MΩ | 0.0001 °C | 0.001 °C | 1 μA |

Thermocouple

Temperature Range -270 °C to 2315 °C (depending on the sensor)

Voltage Range -15 mV to 100 mV

Thermocouple Voltage Accuracy

Accuracy is given as \pm (|% of measurement| + μ V). Basic accuracy specification is for medium or slow sample rate. When using a fast sample rate add the number given in the table to the accuracy specification. If the environment temperature is outside the specified range, multiply the temperature coefficient numbers by the temperature deviation and add to the accuracy specification.

| Range | Accuracy Channel 1 | Ch. x01 – x20 | Fast Sample Rate | T.C./ °C Outside 18 °C to 28 °C |
|------------------|---------------------|---------------|------------------|---------------------------------|
| -15 mV to 100 mV | 0.004 % + 4 μ V | add 2 μ V | add 1 μ V | 0.0005 % + 0.0005 mV |

Thermocouple Reference Junction Accuracy

| Module | CJC Accuracy | T.C./ °C Outside 18 °C to 28 °C |
|----------------------|--------------|---------------------------------|
| DAQ-STAQ Module | 0.25 °C | 0.02 °C |
| High-Capacity Module | 0.6 °C | 0.05 °C |

Thermocouple Temperature Accuracy

Accuracy specifications apply using medium or slow sample rate. When using fast sample rate, increase the accuracy specification by 25 %. If the environment temperature is outside the specified range, increase the accuracy specification by 12 % for every 1 °C outside the specified environment temperature range. Accuracy with fixed/external CJC does not include the accuracy of the reference junction temperature. Linear interpolation may be used between points in the table. Specifications do not include sensor accuracy. The practical range of temperature measurement depends on the sensor.

| Type (Range) | Temperature | Accuracy | | | |
|----------------------------|-------------|----------------------|---------------|-----------------|----------------------|
| | | Fixed / External CJC | | Internal CJC | |
| | | Channel 1 | Ch. x01 – x20 | DAQ-STAQ Module | High-Capacity Module |
| K -270 °C to 1372 °C | -200 °C | 0.28 °C | 0.41 °C | 0.76 °C | 1.60 °C |
| | 0 °C | 0.10 °C | 0.15 °C | 0.29 °C | 0.62 °C |
| | 1000 °C | 0.14 °C | 0.20 °C | 0.32 °C | 0.64 °C |
| T -270 °C to 400 °C | -200 °C | 0.27 °C | 0.40 °C | 0.76 °C | 1.60 °C |
| | 0 °C | 0.10 °C | 0.15 °C | 0.30 °C | 0.65 °C |
| | 200 °C | 0.08 °C | 0.12 °C | 0.23 °C | 0.47 °C |
| | 400 °C | 0.08 °C | 0.11 °C | 0.20 °C | 0.41 °C |
| R -50 °C to 1768 °C | 0 °C | 0.76 °C | 1.13 °C | 1.16 °C | 1.28 °C |
| | 300 °C | 0.42 °C | 0.63 °C | 0.64 °C | 0.71 °C |
| | 1200 °C | 0.33 °C | 0.47 °C | 0.48 °C | 0.52 °C |
| | 1600 °C | 0.34 °C | 0.49 °C | 0.50 °C | 0.54 °C |
| S -50 °C to 1768 °C | 0 °C | 0.74 °C | 1.11 °C | 1.14 °C | 1.26 °C |
| | 300 °C | 0.45 °C | 0.67 °C | 0.68 °C | 0.76 °C |
| | 1200 °C | 0.37 °C | 0.54 °C | 0.55 °C | 0.60 °C |
| | 1600 °C | 0.39 °C | 0.56 °C | 0.57 °C | 0.63 °C |
| J -210 °C to 1200 °C | -200 °C | 0.20 °C | 0.29 °C | 0.65 °C | 1.41 °C |
| | 0 °C | 0.08 °C | 0.12 °C | 0.28 °C | 0.61 °C |
| | 1000 °C | 0.11 °C | 0.14 °C | 0.25 °C | 0.53 °C |
| N -270 °C to 1300 °C | -200 °C | 0.42 °C | 0.62 °C | 0.90 °C | 1.69 °C |
| | 0 °C | 0.15 °C | 0.23 °C | 0.34 °C | 0.64 °C |
| | 500 °C | 0.12 °C | 0.17 °C | 0.24 °C | 0.44 °C |
| | 1000 °C | 0.14 °C | 0.19 °C | 0.26 °C | 0.45 °C |

| Type (Range) | Temperature | Accuracy | | | |
|-------------------------|-------------|----------------------|---------------|-----------------|----------------------|
| | | Fixed / External CJC | | Internal CJC | |
| | | Channel 1 | Ch. x01 – x20 | DAQ-STAQ Module | High-Capacity Module |
| E -270 °C to 1000 °C | -200 °C | 0.17 °C | 0.25 °C | 0.64 °C | 1.42 °C |
| | 0 °C | 0.07 °C | 0.10 °C | 0.27 °C | 0.61 °C |
| | 300 °C | 0.06 °C | 0.09 °C | 0.21 °C | 0.46 °C |
| | 700 °C | 0.08 °C | 0.10 °C | 0.21 °C | 0.45 °C |
| B 100 °C to 1820 °C | 300 °C | 1.32 °C | 1.97 °C | 1.97 °C | 1.97 °C |
| | 600 °C | 0.68 °C | 1.02 °C | 1.02 °C | 1.02 °C |
| | 1200 °C | 0.41 °C | 0.60 °C | 0.60 °C | 0.60 °C |
| | 1600 °C | 0.38 °C | 0.55 °C | 0.55 °C | 0.55 °C |
| C 0 °C to 2315 °C | 600 °C | 0.23 °C | 0.33 °C | 0.37 °C | 0.54 °C |
| | 1200 °C | 0.28 °C | 0.40 °C | 0.45 °C | 0.63 °C |
| | 2000 °C | 0.44 °C | 0.60 °C | 0.66 °C | 0.91 °C |
| D 0 °C to 2315 °C | 600 °C | 0.22 °C | 0.32 °C | 0.34 °C | 0.44 °C |
| | 1200 °C | 0.26 °C | 0.36 °C | 0.39 °C | 0.49 °C |
| | 2000 °C | 0.39 °C | 0.53 °C | 0.56 °C | 0.69 °C |
| G 0 °C to 2315 °C | 600 °C | 0.24 °C | 0.36 °C | 0.36 °C | 0.36 °C |
| | 1200 °C | 0.22 °C | 0.32 °C | 0.32 °C | 0.33 °C |
| | 2000 °C | 0.33 °C | 0.46 °C | 0.46 °C | 0.46 °C |
| L -200 °C to 900 °C | -200 °C | 0.13 °C | 0.19 °C | 0.45 °C | 0.99 °C |
| | 0 °C | 0.08 °C | 0.12 °C | 0.28 °C | 0.62 °C |
| | 800 °C | 0.09 °C | 0.12 °C | 0.23 °C | 0.48 °C |
| M -50 °C to 1410 °C | 0 °C | 0.11 °C | 0.16 °C | 0.30 °C | 0.64 °C |
| | 500 °C | 0.10 °C | 0.15 °C | 0.25 °C | 0.51 °C |
| | 1000 °C | 0.10 °C | 0.14 °C | 0.21 °C | 0.41 °C |
| U -200 °C to 600 °C | -200 °C | 0.25 °C | 0.37 °C | 0.71 °C | 1.48 °C |
| | 0 °C | 0.10 °C | 0.15 °C | 0.30 °C | 0.63 °C |
| | 400 °C | 0.08 °C | 0.11 °C | 0.20 °C | 0.40 °C |
| W 0 °C to 2315 °C | 600 °C | 0.24 °C | 0.36 °C | 0.36 °C | 0.36 °C |
| | 1200 °C | 0.22 °C | 0.32 °C | 0.32 °C | 0.33 °C |
| | 2000 °C | 0.33 °C | 0.46 °C | 0.46 °C | 0.46 °C |

Thermocouple Measurement Characteristics

| Range | Temperature Display Resolution | |
|--------------------|--------------------------------|------------------|
| | Slow / Medium Sample Rate | Fast Sample Rate |
| -270 °C to 2315 °C | 0.01 °C | 0.1 °C |

DC Voltage

| | |
|------------------------------------|--|
| Maximum Input | 50 V on any range |
| Common Mode Rejection | 140 dB at 50 Hz or 60 Hz (1 kΩ unbalance in LOW lead) ±50 V peak maximum |
| Normal Mode Rejection | 55 dB for power line frequency ±0.1 %, ±120 % of range peak maximum |
| A/D Linearity | 2 ppm of measurement + 1 ppm of range |
| Input Bias Current | 30 pA at 25 °C |

DC Voltage Accuracy

Accuracy is given as ± (% measurement + % of range). Basic accuracy specification is for Channel 1, medium or slow sample rate. For channels x01 through x20 or when using Fast sample rate, add the numbers given in the table to the accuracy specification. If the environment temperature is outside the specified range, multiply the temperature coefficient numbers by the temperature deviation and add to the accuracy specification.

| Range | Accuracy Channel 1 | Ch. x01 – x20 | Fast Sample Rate | T.C./ °C Outside 18 °C to 28 °C |
|---------|---------------------|---------------|-----------------------|---------------------------------|
| ±100 mV | 0.0037 % + 0.0035 % | add 2 μV | add 0.0008 % of range | 0.0005 % + 0.0005 % |
| ±1 V | 0.0025 % + 0.0007 % | add 2 μV | add 0.0008 % of range | 0.0005 % + 0.0001 % |
| ±10 V | 0.0024 % + 0.0005 % | – | add 0.0008 % of range | 0.0005 % + 0.0001 % |
| ±50 V | 0.0038 % + 0.0012 % | – | add 0.0008 % of range | 0.0005 % + 0.0001 % |

DC Voltage Input Characteristics

| Range | Resolution | | Input Impedance |
|---------|---------------|--------|----------------------|
| | Slow / Medium | Fast | |
| ±100 mV | 0.1 μV | 1 μV | 10 GΩ ^[1] |
| ±1 V | 1 μV | 10 μV | 10 GΩ ^[1] |
| ±10 V | 10 μV | 100 μV | 10 GΩ ^[1] |
| ±50 V | 100 μV | 1 mV | 10 MΩ ±1 % |

[1] - Input beyond ±12 V is clamped. The clamp current is up to 3 mA.

DC Current

Input Protection 0.15 A resettable PTC

DC Current Accuracy

Accuracy is given as ± (% measurement + % of range). Basic accuracy specification is for medium or slow sample rate. When using a fast sample rate, add the number given in the table to the accuracy specification. If the environment temperature is outside the specified range, multiply the temperature coefficient numbers by the temperature deviation and add to the accuracy specification.

| Range | Accuracy | Fast Sample Rate | T.C./ °C Outside 18 °C to 28 °C |
|---------|--------------------|-----------------------|---------------------------------|
| ±100 μA | 0.015 % + 0.0035 % | add 0.0008 % of range | 0.002 % + 0.001 % |
| ±1 mA | 0.015 % + 0.0011 % | add 0.0008 % of range | 0.002 % + 0.001 % |
| ±10 mA | 0.015 % + 0.0035 % | add 0.0008 % of range | 0.002 % + 0.001 % |
| ±100 mA | 0.015 % + 0.0035 % | add 0.0008 % of range | 0.002 % + 0.001 % |

DC Current Input Characteristics

| Range | Resolution | | Burden Voltage |
|---------|---------------|--------|----------------|
| | Slow / Medium | Fast | |
| ±100 µA | 0.1 nA | 1 nA | <1 mV |
| ±1 mA | 1 nA | 10 nA | <1 mV |
| ±10 mA | 10 nA | 100 nA | <1 mV |
| ±100 mA | 100 nA | 1 µA | <1 mV |

Resistance

Max. Lead Resistance (4-wire ohms) 10 Ω per lead for 100 Ω and 1 kΩ ranges. 1 kΩ per lead on all other ranges.

Resistance Accuracy

Accuracy is given as ± (% measurement + % of range). Basic accuracy specification is for 4-wire resistance, medium or slow sample rate. For 2-wire resistance add 0.02 Ω internal resistance if using Channel 1, or 1.5 Ω if using channels x01 through x20, and add external lead wire resistance. When using Fast sample rate, add the numbers given in the table to the accuracy specification. If the environment temperature is outside the specified range, multiply the Temperature Coefficient numbers by the temperature deviation and add to the accuracy specification.

| Range | Accuracy | Fast Sample Rate | T.C./ °C Outside 18 °C to 28 °C |
|--------|--------------------|---|---------------------------------|
| 100 Ω | 0.004 % + 0.0035 % | add 0.001 % of range | 0.0001 % + 0.0005 % |
| 1 kΩ | 0.003 % + 0.001 % | add 0.001 % of range | 0.0001 % + 0.0001 % |
| 10 kΩ | 0.004 % + 0.001 % | add 0.001 % of range | 0.0001 % + 0.0001 % |
| 100 kΩ | 0.004 % + 0.001 % | add 0.001 % of range | 0.0001 % + 0.0001 % |
| 1 MΩ | 0.004 % + 0.001 % | add 0.002 % of reading plus 0.0008 % of range | 0.0005 % + 0.0002 % |
| 10 MΩ | 0.015 % + 0.001 % | add 0.002 % of reading plus 0.0008 % of range | 0.001 % + 0.0004 % |
| 100 MΩ | 0.8 % + 0.01 % | add 0.01 % of range | 0.05 % + 0.002 % |

Resistance Input Characteristics

| Range | Resolution | | Source Current (open-circuit voltage) |
|--------|---------------|--------|---------------------------------------|
| | Slow / Medium | Fast | |
| 100 Ω | 0.1 mΩ | 1 mΩ | 1 mA (4 V) |
| 1 kΩ | 1 mΩ | 10 mΩ | 1 mA (4 V) |
| 10 kΩ | 10 mΩ | 100 mΩ | 100 µA (6 V) |
| 100 kΩ | 100 mΩ | 1 Ω | 100 µA (12 V) |
| 1 MΩ | 1 Ω | 10 Ω | 10 µA (12 V) |
| 10 MΩ | 10 Ω | 100 Ω | 1 µA (12 V) |
| 100 MΩ | 100 Ω | 1 kΩ | 0.1 µA (12 V) |

Digital I/O

| | |
|--------------------------------|-----------------------|
| Absolute Voltage Range | -4 V to 30 V |
| Input Minimum Logic High | 2.0 V |
| Input Maximum Logic Low | 0.7 V |
| Output Type | open drain active low |
| Output Logic Low (<1 mA) | 0 V to 0.7 V |
| Maximum Sink Current | 50 mA |
| Output Resistance | 47 Ω |

Totalizer

| | |
|------------------------------|-------------------|
| Absolute Voltage Range | -4 V to 30 V |
| Minimum Logic High | 2.0 V |
| Maximum Logic Low | 0.7 V |
| Minimum Pulse Width | 50 μ s |
| Maximum Frequency | 10 kHz |
| Debounce Time | 1.7 ms |
| Maximum Count | 1048575 (20 bits) |

Trigger

| | |
|------------------------------|--------------|
| Absolute Voltage Range | -4 V to 30 V |
| Minimum Logic High | 2.0 V |
| Maximum Logic Low | 0.7 V |
| Minimum Pulse Width | 50 μ s |
| Maximum Latency | 100 ms |

Alarm Output

| | |
|--------------------------------|-----------------------|
| Absolute Voltage Range | -4 V to 30 V |
| Output Type | open drain active low |
| Output Logic Low (<1 mA) | 0 V to 0.7 V |
| Maximum Sink Current | 50 mA |
| Output Resistance | 47 Ω |

1586-2588 DAQ-STAQ Input Module Specifications

General

| | |
|---|-------------------|
| Maximum Input | 50 V |
| Offset Voltage | <2 μ V |
| 3-Wire Internal Resistance Mismatch | <50 m Ω |
| Basic CJC Accuracy | 0.25 $^{\circ}$ C |

1586-2586 High-Capacity Input Module Specifications

General

| | |
|---|------------------|
| Maximum Input | 50 V |
| Offset Voltage | <2 μ V |
| 3-Wire Internal Resistance Mismatch | <50 m Ω |
| Basic CJC Accuracy | 0.6 $^{\circ}$ C |

Chapter 2

Initial Setup and Configuration

| Title | Page |
|---|-------------|
| Introduction..... | 2-3 |
| Set the Regional Voltage | 2-3 |
| Connect to Mains Power..... | 2-4 |
| Set the Handle Position..... | 2-5 |
| Power On and Standby | 2-6 |
| Warm-Up the Product..... | 2-7 |
| Configure the Product..... | 2-7 |
| Input Module and Relay Card Installation..... | 2-8 |
| Install a DAQ-STAQ Multiplexer Connection Module..... | 2-11 |
| Set Up Security | 2-13 |

Introduction

This chapter supplies information and instructions on how to set up and configure the Product for first time use.

Set the Regional Voltage

The Product is equipped with a voltage selector that must be set for the region of use before the mains power cord is connected. The selector can be set to 100 V, 120 V, 220 V, or 240 V. See Figure 2-1 for an illustration on how to set the voltage selector.

See Chapter 6 for instructions on how to change the fuse. Each voltage selection requires a specific fuse. See Table 2-1.

Table 2-1. Fuses

| Voltage Selector | Fuse | Fluke Part Number |
|------------------|----------------------------|-------------------|
| 100 V | 0.25 A, 250 V (slow blow) | 166306 |
| 120 V | 0.25 A, 250 V (slow blow) | 166306 |
| 220 V | 0.125 A, 250 V (slow blow) | 166488 |
| 240 V | 0.125 A, 250 V (slow blow) | 166488 |

⚠ Caution

To prevent damage to the Product, make sure the regional voltage selector is in the correct position for the region of use before mains power is connected.

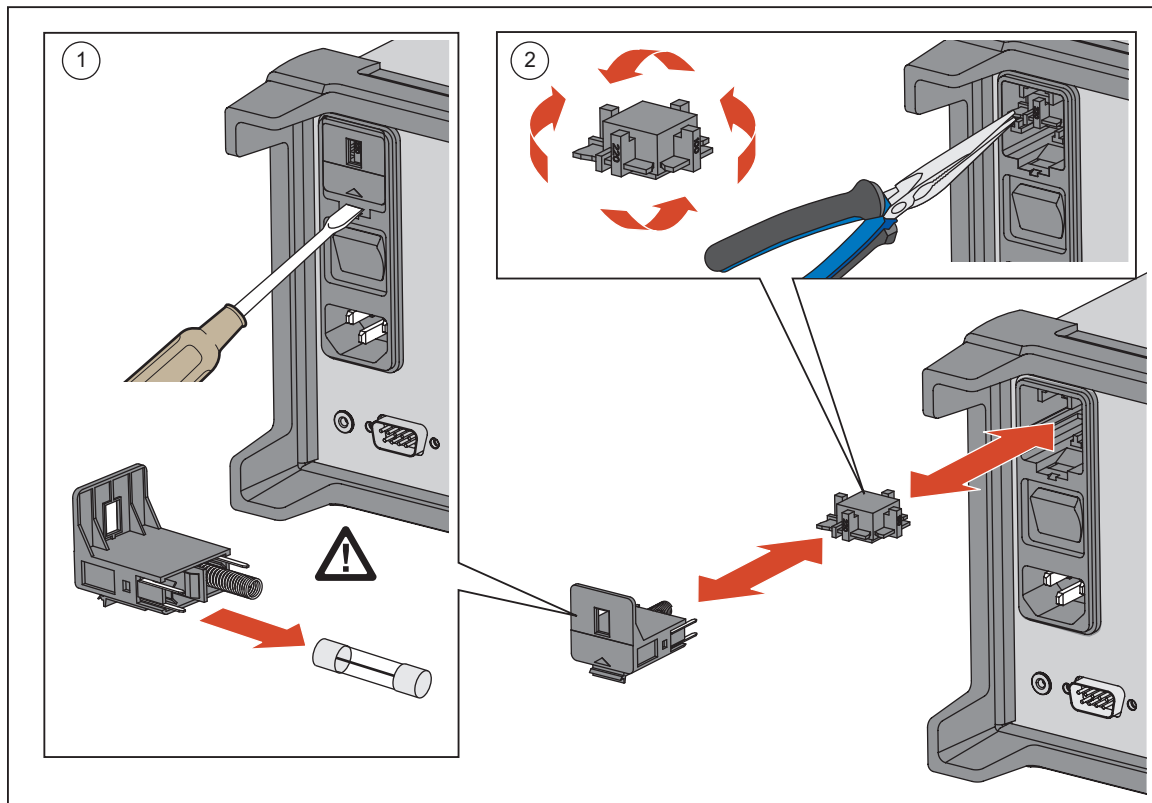

Figure 2-1. Fuse Replacement and Line-Voltage Selection

hcn027.eps

Connect to Mains Power

Use the mains power cord to connect the Product to a 100 V ac, 120 V ac, or 230 V ac nominal outlet as shown in Figure 2-2.

⚠⚠ Warning

To prevent possible electrical shock, fire, or personal injury:

- Use only the mains power cord and connector approved for the voltage and plug configuration in your country and rated for the Product.
- Replace the mains power cord if the insulation is damaged or if the insulation shows signs of wear.
- Make sure the ground conductor in the mains power cord is connected to a protective earth ground. Disruption of the protective earth could put voltage on the chassis that could cause death.
- Do not put the Product where access to the mains power cord is blocked.

⚠ Caution

To prevent damage to the Product, make sure the regional voltage selector is in the correct position for the region of use before mains power is connected.

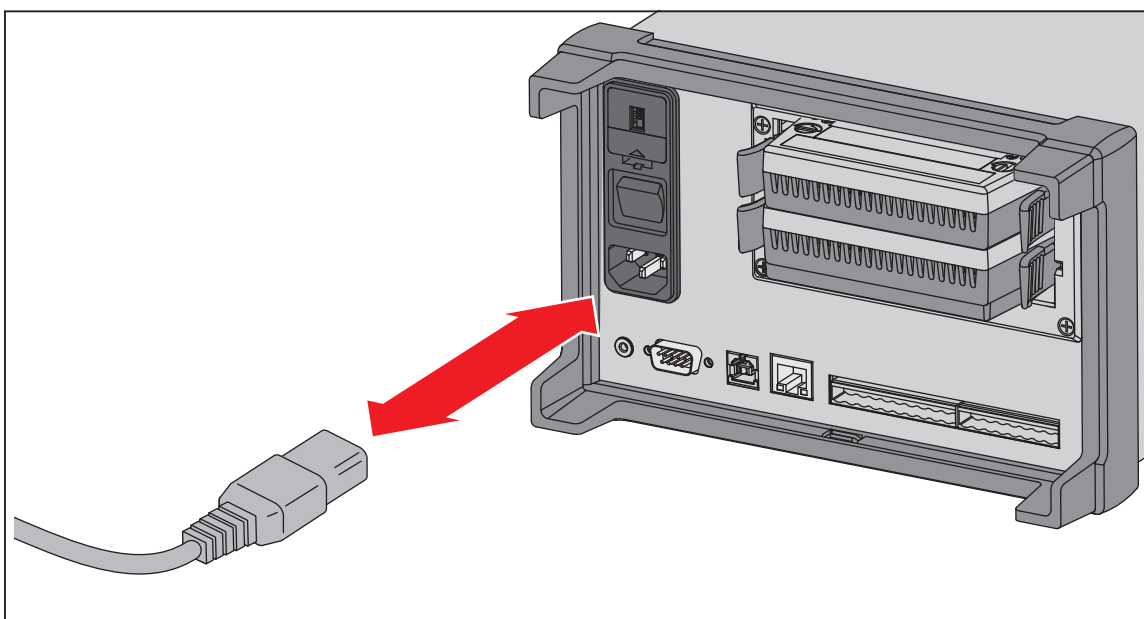

Figure 2-2. Mains Power Cord Connection

hcn058.eps

Set the Handle Position

The handle is used to easily transport the Product but can also be used as a stand. Figure 2-3 shows the various handle positions and also shows how to remove and install the handle and the protective rubber boots.

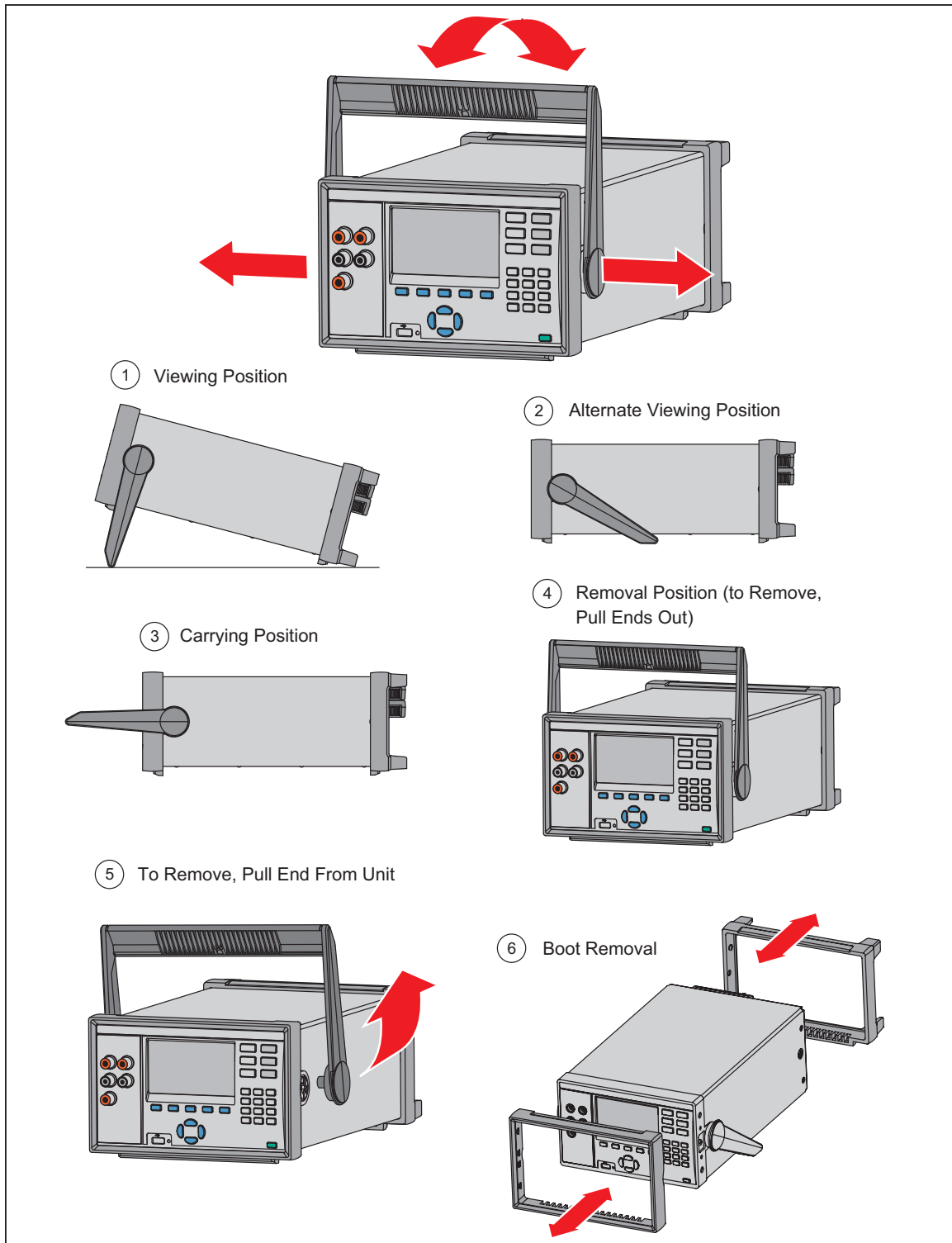

Figure 2-3. Handle Positions and Boot Removal

Hcn003.eps

Power On and Standby

As shown in Figure 2-4, the Product has a main power switch located on the rear panel that supplies power to the unit, and a Standby key (⏻) on the front panel that puts the Product in a standby mode. Push the (I) side of the main power switch to power on the Product. As the Product powers on, a startup screen is shown on the display while the Product performs a self-check. This self-check can take up to 2 minutes to complete and if the Product detects any errors, an error message is shown on the display that contains the error description along with an error code to help troubleshoot the problem (see “Error Messages” in Chapter 7).

Once the Product is powered on, use the Standby key (⏻) to put the Product in standby. When in standby, the display, keys, and functions are disabled while the internal components remain powered on and warmed up (see “Warm-Up the Product”).

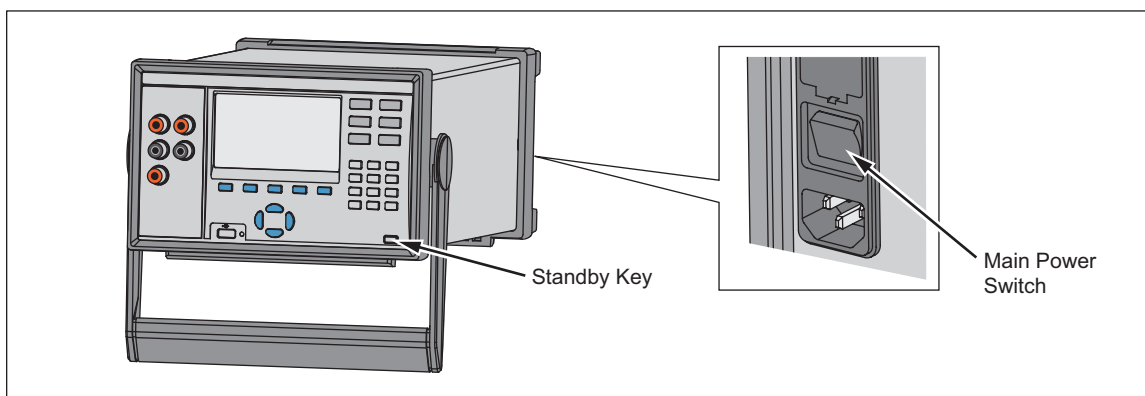

Figure 2-4. Main Power Switch and Standby Key

hcn052.eps

Warm-Up the Product

It is recommended that the Product be warmed up before use to stabilize the environmentally controlled components. This will ensure the best performance to the specification listed in Chapter 1. Sufficient warm-up times are as follows:

- If the Product has been powered off for 30 minutes or more, let it warm-up for 1 hour or more.
- If the Product has been powered off for less than 30 minutes, let it warm-up for a minimum of two times the length of time it was powered off. For example, if Product has been turned off for 10 minutes, let it warm-up for 20 minutes.

Configure the Product

Use the Instrument Setup menu to configure the Product. To open the Instrument Setup menu, push  on the front panel. To change a setting, highlight the setting then use the menu softkeys shown on the display to edit the settings.

Table 2-2 shows the menu items and selections available in the Instrument Setup menu.

Table 2-2. Instrument Setup Menu

| Menu Item | Description | Selections Available |
|--------------------|--|---|
| Language | Changes the display language. <i>Note</i> <i>If the incorrect language is set by accident, push  then push F1. This temporarily resets the language to English.</i> | English Español 中文 Русский Français 日本語 Deutsch 한국어 Portugués |
| Firmware | Shows the firmware version installed, model number, and serial number | -- |
| Date | Changes the date and date format shown on the top-right corner of the display. This date is also used for timestamps in the data log. | MM-DD-YYYY YYYY-MM-DD DD/MM/YYYY |
| Time | Changes the time and time format shown on the top-right corner of the display. This time is also used for timestamps in the data log. | 12H or 24H |
| Decimal Format | Changes the decimal format to show a comma or decimal. | Period (0.000) or Comma (0,000) |
| Display Brightness | Changes the display brightness level. | High, Med, or Low |
| Keypad Beep | Turn on or turn off the key beep that sounds when a key is pushed. | ON or OFF |

Table 2-2. Instrument Setup Menu (cont.)

| Menu Item | Description | Selections Available |
|---------------------|---|---|
| Screen Saver | Change the wait time or disable the screensaver. | Never, 15 Min, 30 Min, or 60 Min |
| Calibration Date | Shows the date that the Product was last calibrated. See the <i>1586A Calibration Manual</i> for more information. | -- |
| Password Management | Change the Admin and User profile passwords. | See "Set Up Security" in this chapter for more information. |
| Resume Scan | Sets the Product to automatically turn on and resume scanning and recording after a power loss. | See "Automatic Power Loss Scan Resume" in Chapter 4 for more information. |
| Remote Port | Configure the LAN Ethernet or serial USB communication settings. | See the <i>1586A Remote Programmers Guide</i> for more information. |
| Relay Counter | Shows how many times the channel relays have been scanned along with the name, serial number, and calibration date of the Input Module. | -- |

Input Module and Relay Card Installation

Before an Input Module can be inserted into the rear panel, a relay card must be installed. Standard product configurations include at least one slot preconfigured with a relay card. Use the procedure below and refer to Figure 2-6 as necessary to install the relay card:

1. Power off the Product with the main power switch.
2. Remove the four screws that secures the plastic frame to the rear panel.
3. Remove the plastic frame.
4. Slide the aluminum slot protector out of the Product.
5. Carefully align the rails of the relay card into the slot guides.
6. Slowly push the relay card into the Product until the card is fully seated.

⚠ Caution

Do not force the relay card into the slot. The card should easily move when the rails of the relay card are properly aligned in the slot guides.

7. Install the plastic frame and secure it to the rear panel with four screws.

To install the Input Module:

1. Power off the Product with the main power switch.
2. Slide an Input Module into the slot the relay card was installed.
3. Power on the Product with the main power switch.
4. Verify that the module indicator appears green on the main screen (see Figure 2-5).

Note

If the module indicator is not green, the Product did not recognize the Input Module or relay card. Refer to the troubleshooting section in Chapter 7.

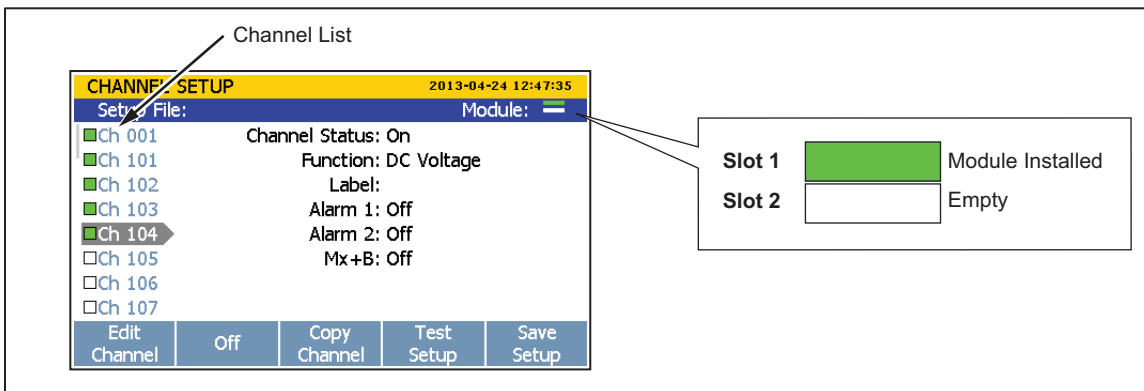

Figure 2-5. Module Indicator Example

hcn016.eps

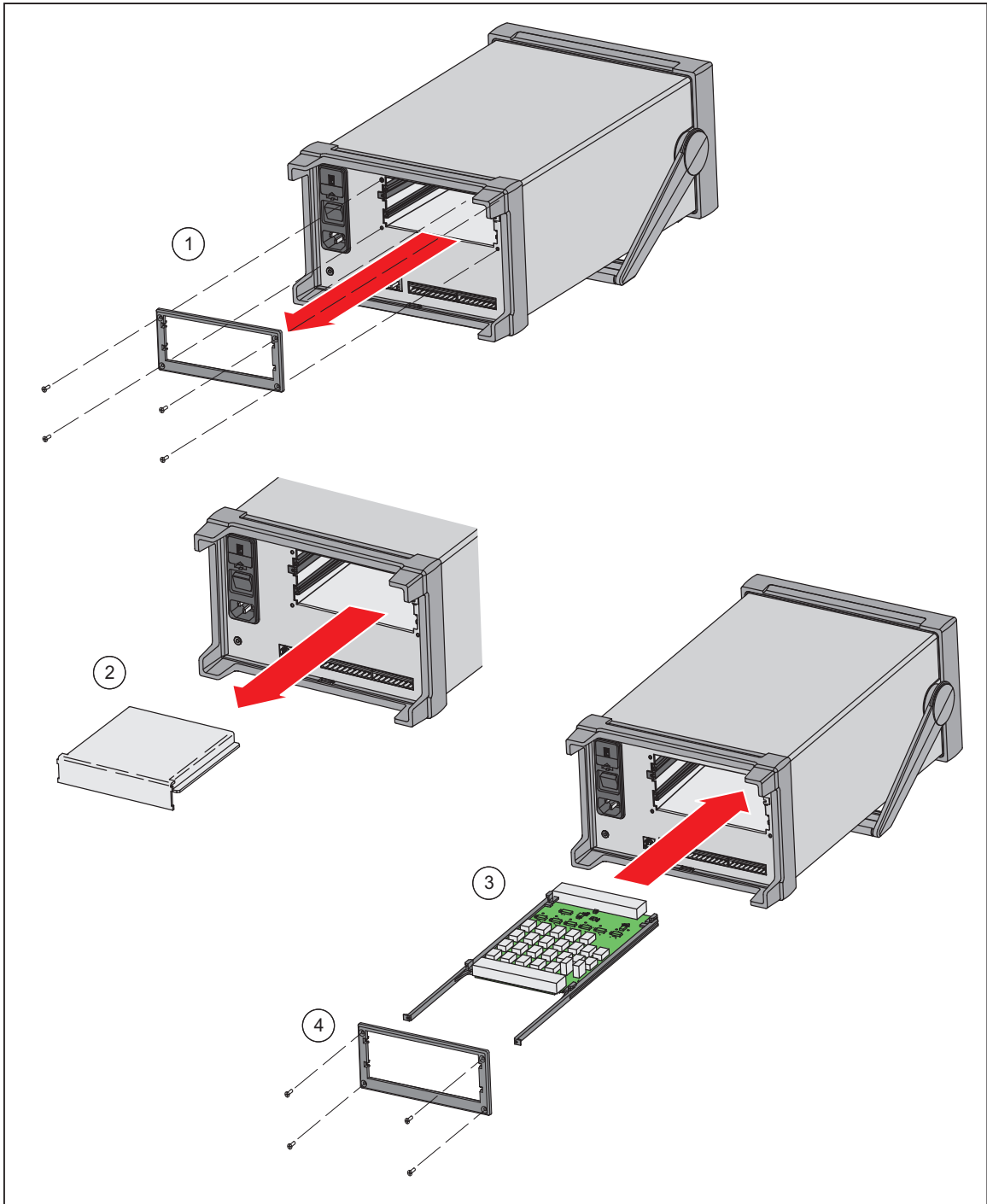

Figure 2-6. Relay Card Installation

hcn018.eps

Install a DAQ-STAQ Multiplexer Connection Module

In order to use an additional DAQ-STAQ Multiplexer Connection Module (the Multiplexer), an interface relay card must be installed. Use the procedure below and refer to Figure 2-7 as necessary.

To install an interface relay card:

1. Turn off the Product.
2. Remove the four screws that secures the plastic frame to the rear panel.
3. Remove the plastic frame.
4. Slide the aluminum slot protector out of the Product.
5. Carefully align the rail of the relay card into the slot guides.
6. Slowly push the relay card into the Product until the card is fully seated.

⚠ Caution

Do not force the card into the slot. The card should easily move when the rails of the relay card are properly inserted in the slot guides.

7. Install the plastic frame and secure it to the rear panel with four screws.
8. Connect the Product to a DAQ-STAQ Multiplexer with two signal cables.
9. Turn on the Product.
10. Verify that the module indicator appears green on the main screen (see Figure 2-5).

Note

If the module indicator is not green, the Product did not recognize the module. Refer to the troubleshooting section in Chapter 7.

To remove an interface relay card:

1. Complete steps 1 through 3 of the installation procedure.
2. Pull out the interface relay card.
3. Slide the aluminum slot protector into the Product.
4. Install the plastic frame and secure it to the rear panel with four screws.

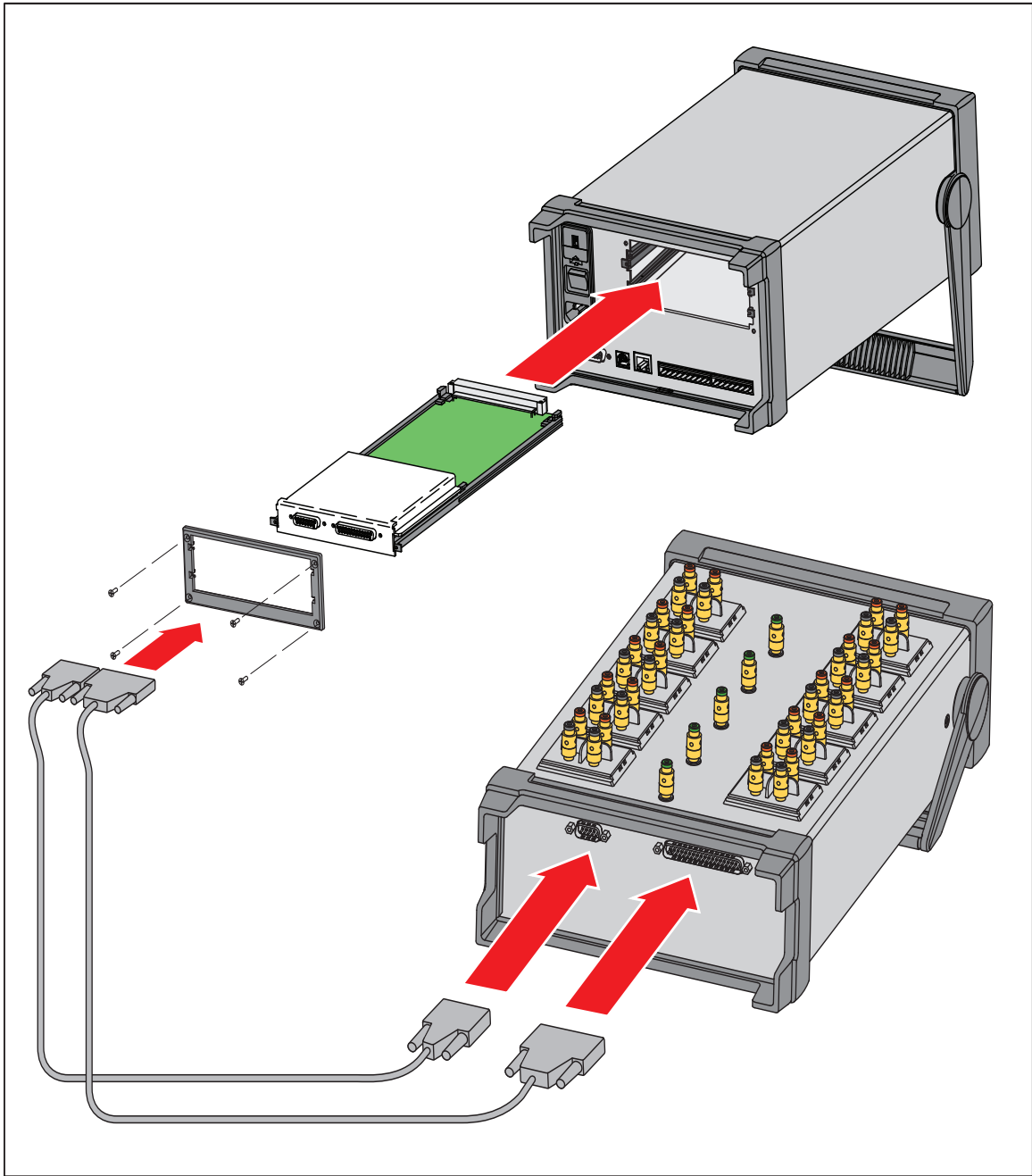

Figure 2-7. DAQ-STAQ Multiplexer Installation

hcn032.eps

Set Up Security

The Product has one administration (Admin) and five User profiles. The Admin profile is used for three purposes:







- To protect the Product from accidental or unintentional changes to the calibration coefficients. The Admin profile is the only profile that can open the Calibration menu to calibrate the Product. Refer to the *1586A Calibration Manual* for calibration and adjustment instructions.
- To clear the memory or reset the Product to factory defaults. See Chapter 6.
- To change passwords of the User profiles.

The User profiles sole purpose is to produce secure data files that are traceable back to the user who performed the test (commonly referred to as test traceability). See Chapter 4 for more information.

Note

The user profile names are fixed and cannot be changed.

The Product ships from the factory with a default Admin password of “1586”. To change the Admin or User profile password:

1. Push .
2. Highlight **Password Management** then push .
3. Enter the default password of **1586** (or the current Admin password if it was previously changed) then push .
4. Select an **Admin** or **User** profile then push .
5. Enter a new password then push .
6. Enter the password again to confirm then push .

Chapter 3

Input and Channel Configuration

| | Title | Page |
|---|--------------|-------------|
| Introduction..... | | 3-3 |
| Input Wiring..... | | 3-3 |
| The 1586-2586 High Capacity Input Module..... | | 3-3 |
| The 1586-2588 DAQ-STAQ Multiplexer Connector Module | | 3-4 |
| Wiring Safety and Considerations..... | | 3-5 |
| 3-Wire and 4-Wire Sense Input Configuration..... | | 3-6 |
| Input Types and Wiring Diagrams | | 3-7 |
| Input Wiring Instructions | | 3-8 |
| Channel Configuration..... | | 3-10 |
| About Channel Numbers | | 3-10 |
| Basic Channel Operations | | 3-12 |
| Open the Channel Setup Menu | | 3-12 |
| Set Channels to ON or OFF | | 3-13 |
| Verify a Channel | | 3-14 |
| Zero a Channel..... | | 3-14 |
| Copy a Channel..... | | 3-15 |
| Save or Load a Channel Configuration (Setup File)..... | | 3-16 |
| Reset the Channel and Test Configuration..... | | 3-18 |
| Analog Channel Configuration (Ch001, Ch101 to Ch222)..... | | 3-18 |
| Current and Voltage Channels | | 3-19 |
| Resistance Channels..... | | 3-20 |
| Thermocouple Channels..... | | 3-21 |
| Thermistor Channels | | 3-22 |
| PRT Channels..... | | 3-23 |
| Digital I/O (DIO) Channel Configuration (Ch401)..... | | 3-24 |
| Totalizer Channel Configuration (Ch402)..... | | 3-25 |
| Read Mode | | 3-25 |
| Debounce | | 3-25 |
| Math Channel Configuration (Ch501 to Ch520)..... | | 3-27 |
| Mx+B, Alarms, and Channel Options..... | | 3-30 |
| Mx+B Scaling..... | | 3-30 |
| HI and LO Channel Alarms..... | | 3-31 |
| Channel Delay | | 3-33 |
| Rate of Change | | 3-33 |
| Display As | | 3-34 |
| Open Detect..... | | 3-34 |
| Probe Library | | 3-34 |

Introduction

This chapter supplies instructions on how to wire inputs to the Input Module then configure the associated channel.

Input Wiring

The 1586-2586 High Capacity Input Module

The 1586-2586 High Capacity Input Module (the Input Module) is used to wire inputs of various types to the Product (see Figure 3-1). Each Input Module has 20 analog channels (ChX01 through ChX20) that can be configured to measure temperature, resistance, and dc volts and two low-burden current channels (ChX21 and ChX22) that measure dc current without the use of an external shunt resistor.

Note

To expand the functionality of the Product, current sources can also be connected to channels ChX01 through ChX20 by the use of an accessory shunt resistor. See Chapter 6 for part number and ordering information.

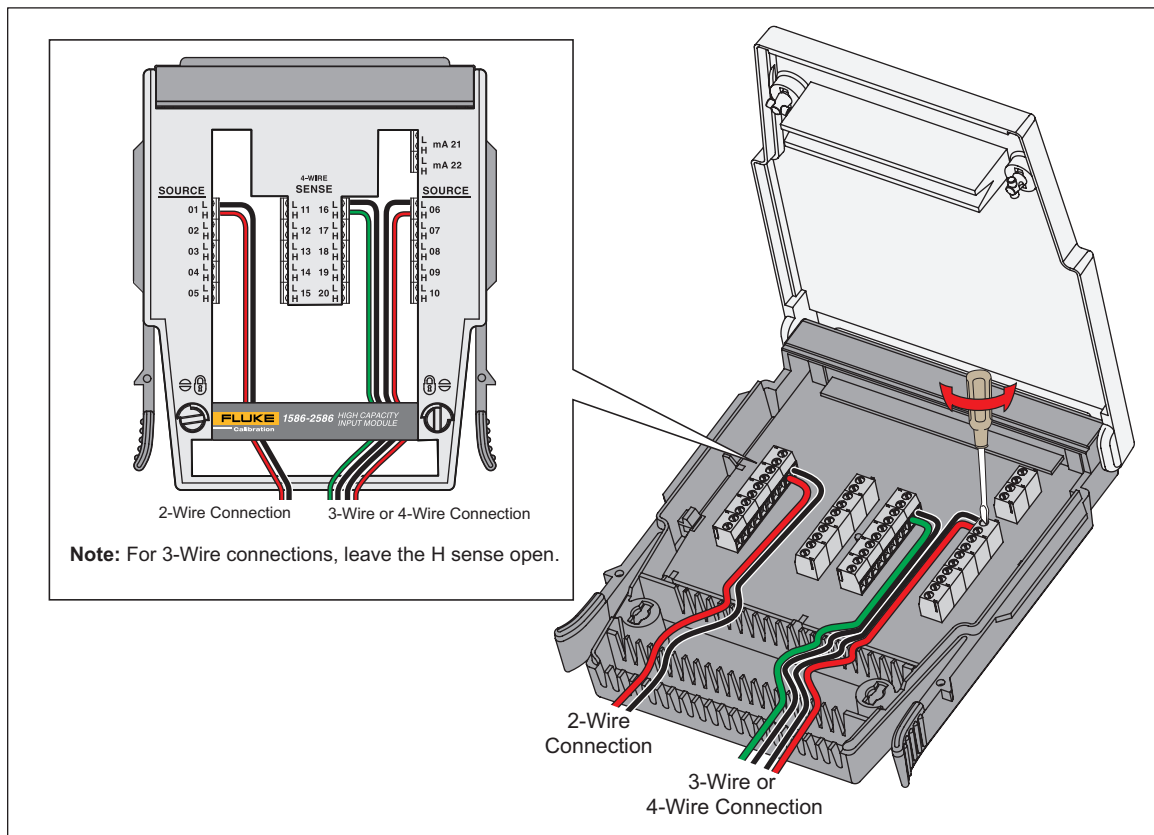

Figure 3-1. 2-Wire, 3-Wire, and 4-Wire Input Module Connections

hcn012.eps

The 1586-2588 DAQ-STAQ Multiplexer Connector Module

The 1586-2588 DAQ-STAQ Multiplexer Connector Module (the Multiplexer) is an external, bench-top accessory that is used to quickly wire inputs of various types to the Product (see Figure 3-2). Each Multiplexer has 20 analog channels (ChX01 through ChX20) that can be configured to measure temperature, resistance, and dc volts.

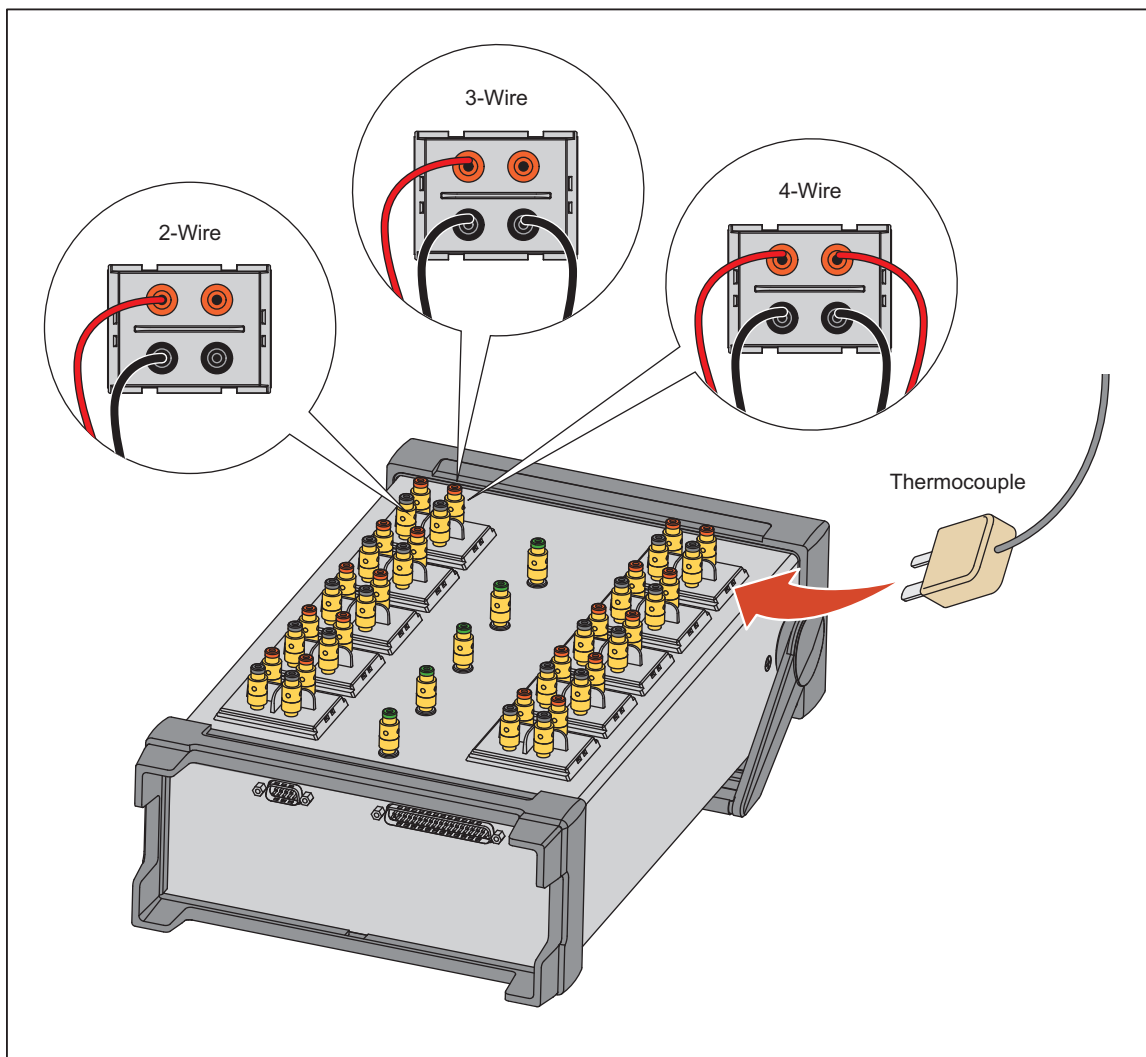

Figure 3-2. 2-Wire, 3-Wire, and 4-Wire Multiplexer Connections

hcn040.eps

Wiring Safety and Considerations

⚠️⚠️ Warning

To prevent possible electrical shock, fire, or personal injury:

- Consider all accessible channels to be hazardous live and an electric shock hazard if any channel is connected to a hazardous voltage source.
- Do not remove, touch, or change the internal wiring of hazardous inputs until the input source is turned off.
- Remove inputs from hazardous voltage sources before an input module is opened.
- Use the correct terminals, function, and range for measurements.
- Make sure proper insulation is maintained between channel wiring terminations and that no loose strands are outside of the terminal block connections.

⚠️ Caution

To prevent damage to the Product, do not exceed the specified input voltage levels.

Shielded wires and sensors (such as thermocouples) should be used in environments where "noisy" voltage sources are present. When shielded wiring is used, the shield is normally connected to the L (low) input terminals for each channel. Alternate configurations should be examined for each equipment application.

3-Wire and 4-Wire Sense Input Configuration

For improved resistance measurement accuracy, the Product can connect to 3-wire (PRT only) and 4-wire instruments with sense connections.

Sense connections cancel out the resistance of the test lead or wire and significantly improves the accuracy of the measurement. As shown in Table 3-1, many thermistors, platinum-resistance thermometers (PRTs) and resistors use a 3-wire or 4-wire sense connection to eliminate lead wire resistance errors.

For 2-wire measurements, the wires can be connected to either the source or sense channels ChX01 through ChX20. For 3-wire or 4-wire resistance measurements, the source wires must be connected to channels ChX01 through ChX10 and the sense wires to the set of terminals directly across from where the source is connected (channels ChX11 through ChX20).

Note

The Product will not show or let the user select a 3-wire or 4-wire input on channels ChX11 through ChX20.

Figure 3-3 shows an example of a 4-wire input (PRT) with sense wires connected to the Input Module, then how it would look in the Channel Setup menu once it is properly configured.

To use the sense connections, the channel connected to the source wires must be configured as a 3-wire or 4-wire input as described in “Channel Configuration Procedures” on page 3-10. When a channel is configured as a 3-wire or 4-wire input, the Product automatically reserves the sense channel across from the source that prevents the channel from being independently configured, as shown in Figure 3-3.

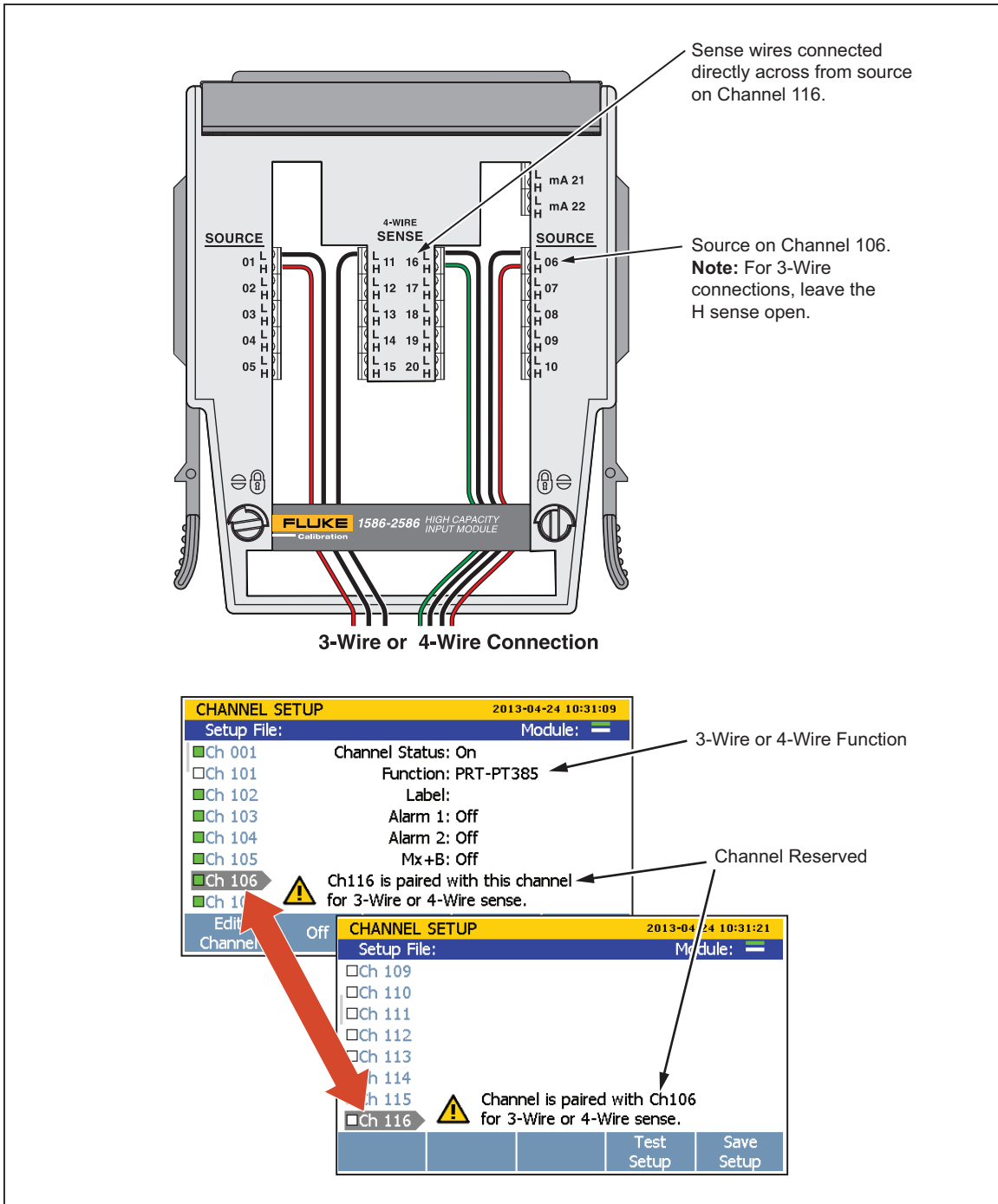

Figure 3-3. 3-Wire and 4-Wire Channel Reservation

hcn014.eps

Input Types and Wiring Diagrams

Table 3-1 lists the type of input types the Product can measure and the wiring polarity that should be used to wire it to the Input Module.

Table 3-1. Types of Inputs

| Type of Input | Range and Types | Channel Configuration Reference | Wiring Polarity |
|---|---|---------------------------------|--|
| DC Voltage | Range: 0 V to 50 V | Page 3-19 | |
| DC Current ^[1] | Range: 0 mA to 100 mA | Page 3-19 | |
| Resistance (Ω) | 2-Wire or 4-Wire ^[3] Range: 0 Ω to 100 MΩ | Page 3-20 | <p>2-Wire</p> <p>3-Wire</p> <p>4-Wire</p> |
| Platinum Resistance Thermometer (PRT) | 2-Wire, 3-Wire or 4-Wire Types: ITS90, CVD, PT385, PT392 | Page 3-23 | |
| Thermistor | 2-Wire or 4-Wire Types: R(T) ^[2] , 2.252 kΩ, 5 kΩ, 10 kΩ | Page 3-22 | |
| Thermocouple | Types: B, C, D, E, G, J, K, L, M, N, R, S, T, U, W, POLY ^[2] | Page 3-21 | |
| <p>Note</p> <p>[1] – Each Input Module has two terminal sets (mA 21 and mA 22) that are dedicated to current measurements.</p> <p>[2] – Custom characterized.</p> <p>[3] – 100 MΩ is for Ch001 only. Other analog channels are 10 MΩ Max.</p> | | | |

Input Wiring Instructions

Use the procedure below and refer to Figure 3-1 for instructions on how to wire a 2-wire, 3-wire, or 4-wire input to the Input Module.

⚠️ Warning

To prevent possible electrical shock, fire, or personal injury, read the Wiring Safety and Considerations section on page 3-5.

1. Power off the Product with the main power switch.

2. Squeeze together the release tabs located on both sides of the Input Module then pull the module out of the Product.
3. Use a straight-head screw driver to rotate the cover locks to the unlock position then open the cover.

⚠ Caution

To prevent damage to the module, never turn the cover locks more than quarter of a turn.

4. Connect the positive source wire to the H terminal and the negative source wire to the L terminal. For 3-wire and 4-wire sense connections, connect the sense wires to the terminals directly across from the source wires. See “Sense Input Configuration” on page 3-6.
5. Route the wires through the strain-relief pins then out the back of the Input Module. If necessary, the rubber wire compressor used to secure the wires can be removed for more room.
6. Close the Input Module cover and rotate the cover locks to the locked position.
7. Align the Input Module on the guide rails and carefully slide the module into the connector at the rear of the Product until it latches in place.
8. Power on the Product with the main power switch. After powered on, the Product tests the connection to the Input Module. If the Input Module is recognized, the module indicator changes to green and shows all channels available on the left side of the Channel Setup menu as shown in Figure 3-4. If the module indicator does not turn green, refer to the troubleshooting information in Chapter 4.
9. Configure the channel. For instructions on how to configure the various input types, see “Channel Configuration” on page 3-10.

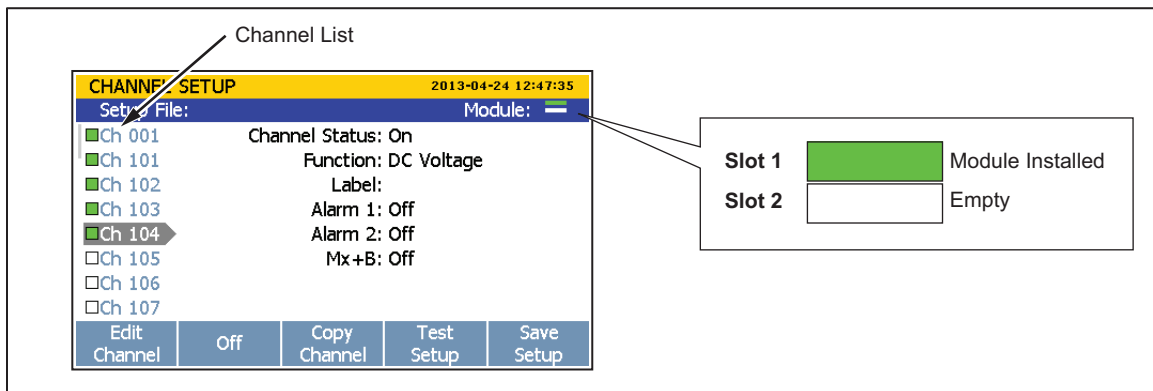

Figure 3-4. Module Indicator (Input Module Installed Shown)

hcn016.eps

Channel Configuration

This section contains instructions on how to configure the channels after the inputs are connected to the Input Module.

About Channel Numbers

A channel number (Ch) is a numerical identification associated with a set of terminals on the Input Module. The channel number of the input is determined by the slot number the Input Module is in (1 or 2) followed by the number of the terminal the input is connected to (1 to 22) as illustrated in Figure 3-5. The front-panel inputs are permanently assigned to channel Ch001. Here are some examples on how to determine the channel number of an input:

- A voltage source is connected to input terminal 4 (04) in the Input Module and then slid into slot 1. The channel is Ch104.
- A thermistor source is connected to input terminal 8 (08) in the Input Module and then slid into slot 2. The channel is Ch208.
- A voltage source is connected to the front-panel terminals. The channel is Ch001.

Table 3-2 shows channel types and channel numbers.

Table 3-2. Channel Types and Numbers

| Channel Type | Channel Numbers and Range | Reference |
|------------------------------------|---------------------------|--|
| Input Channel (front panel) | Ch001 | See "Analog Channel Configuration (Ch001, Ch102 to Ch222)" on page 3-18. |
| Input Channel (rear panel, slot 1) | Ch101 to Ch122 | |
| Input Channel (rear panel, slot 2) | Ch201 to Ch222 | |
| Digital I/O Channel | Ch401 | See "Digital I/O Channel Configuration (Ch401)" on page 3-24. |
| Totalizer Channel | Ch402 | See "Totalizer Channel Configuration (Ch402)" on page 3-25. |
| Math Channel | Ch501 to Ch520 | See "Math Channel Configuration (Ch501 to Ch520)" on page 3-26. |

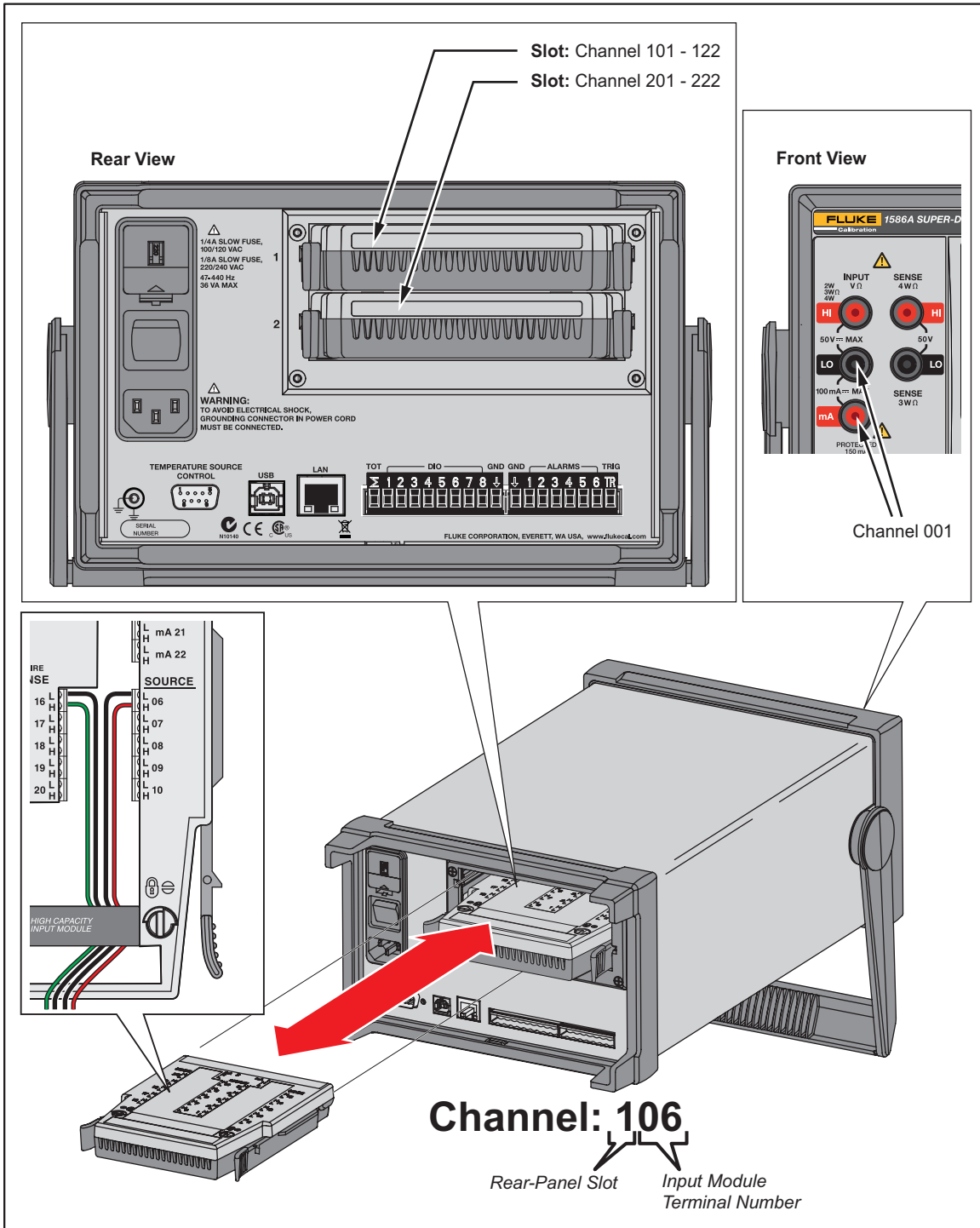

Figure 3-5. Example Channel Assignment

hcn026.eps

Basic Channel Operations

Use the instructions in this section to perform basic channel operations.

Open the Channel Setup Menu

The Channel Setup menu lets the user manage channels, verify inputs, and also set up tests. To open the menu, push **CHANNEL SETUP** on the front panel.

To select channels, use the **←** and **→** arrow keys. To quickly move up and down the list of channels, use the **↑** and **↓** arrow keys.

Note

The Channel Setup menu cannot be accessed while a scan is in progress.

Table 3-3. Channel Setup Menu

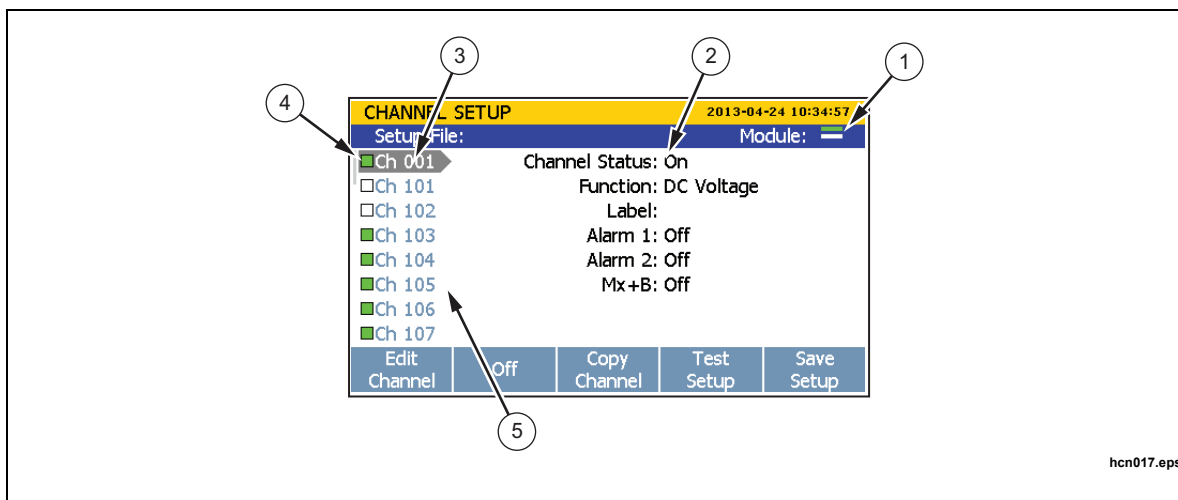

| Item | Function |
|------|--|
| ① | Module indicator that has two bars to show which Input Modules are connected and registered. The top indicator is slot 1 and the bottom indicator is slot 2. When a module is in a slot, the indicator is green. When a slot is empty, the indicator is white. |
| ② | Channel status. When ON, the channel can be configured and the channel status indicator to the left of the channel is green. When OFF, the channel information is not shown and the channel status indicator is white. |
| ③ | List of available channels. Channels show in the list only when an Input Module relay card is installed in a slot or a DAQ-STAQ Multiplexer is connected. For example, Ch201 through Ch222 will not show in the channel list until an Input Module relay card is installed into slot 2. <i>Note</i> <i>Ch001 is always the front-panel terminals and always shows in the channel list.</i> |

Table 3-3. Channel Setup Menu (cont.)

| Item | Function |
|------|--|
| ④ | Channel status indicator. When a channel is set to ON, the channel status indicator is green. When OFF, the channel status indicator is white. |
| ⑤ | Channel selection indicator. When a channel is selected, the channel information shows on the screen. Use and to move up or down one channel at a time. Use or to jump to the next module number (for example, to jump from channel Ch101 to channel Ch201). |

Set Channels to ON or OFF

To scan, monitor, or record an input, the associated channel must be set to ON and configured. When a channel is set to ON, it is referred to as “active”. The channel indicator appears green when set to ON and white when set to OFF as shown in Figure 3-6. To set a channel to ON, push then push . Push again to set the channel to OFF.

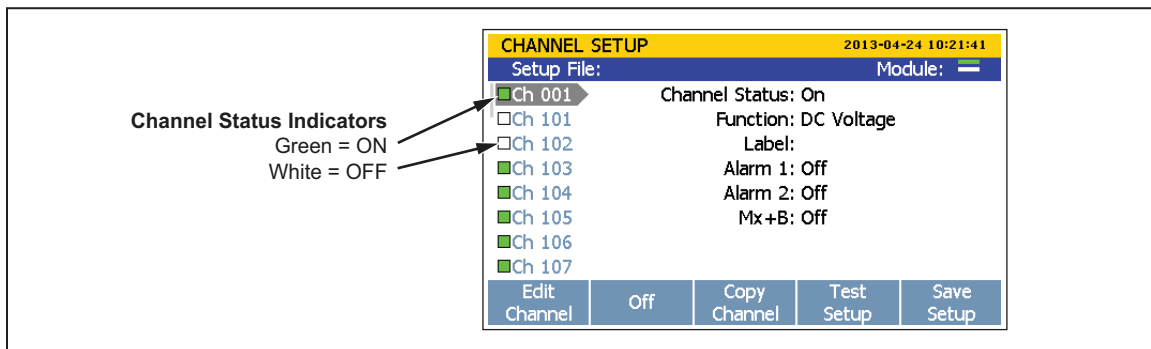

Figure 3-6. Channel Status Indicators

hcn006.eps



When a channel is set to ON, the channel loads the previous channel configuration. If the channel was not previously configured, the default channel settings are loaded. To change the or edit the channel:

1. Push .
2. Push or to highlight a channel.
3. Push to edit the channel.
4. Set the **Channel Status** to **ON** if necessary.

The display opens a channel configuration sequence that prompts the user to select key parameters for the specific channel type. These sequences are shown and described in the analog channel configuration section that starts on page 3-18.

Note





If the configuration sequence is skipped or stopped before the sequence is complete, the default channel settings are used for the skipped steps. Some channel settings are not able to be configured or changed outside of the setup sequence.

Use the  or  to select the settings and input values with the numeric keypad. Once a parameter is set, push  to save the setting.

Verify a Channel

After a channel is set to ON and configured, a direct measurement can be made to verify that the channel is configured properly.

To verify a channel:

1. Turn on the input source that is connected to the Product.
2. Push .
3. Push  or  to highlight a channel.
4. Set the channel to **ON**.
5. Push  to edit the channel.
6. Push  to open the Verify Channel menu.
7. Evaluate the measurement and zero the channel if necessary. See “Zero a Channel”.

Zero a Channel

In certain applications, it may be necessary to zero the channel in order to make measurements without unwanted offsets or noise levels. The zero channel function is located in the Verify Channel menu that is accessed by a softkey in the Channel Setup menu. The Product uses the Mx+B offset value to zero a channel. To do this, the Product calculates the offset required to convert the measurement to a zero value, sets Mx+B to ON, and loads the calculated offset value into the Mx+B settings. To clear the zero, the offset value can be manually set back to the original value (usually “0”) or Mx+B can be set to OFF if it was off before the channel was zeroed. Zero offset values can be viewed in the setup file associated with the scan data file (see Chapter 4).

Note

When a zero is performed, the Product will overwrite any custom offset values in the Mx+B settings. If a channel has a custom Mx+B offset, make note of the offset value before the channel is zeroed so it can be referred to later if necessary.

To zero a channel:

1. Turn on the input source that is connected to the Product.

2. Push **CHANNEL SETUP**.
3. Push **▼** or **▲** to highlight a channel.
4. Push **F1** to edit the channel.
5. Push **F1** to open the Verify Channel menu.
6. Push **F3** to zero the channel. A confirmation message appears, select **OK** to continue or **Cancel** to disregard the changes and return to previous menu. After **OK** is selected, the Product sets the Mx+B to **ON** and loads the calculated offset into the Mx+B offset setting. To clear the zero function, set the Mx+B back to the original values. See “Mx+B Scaling” on page 3-30 for instructions.

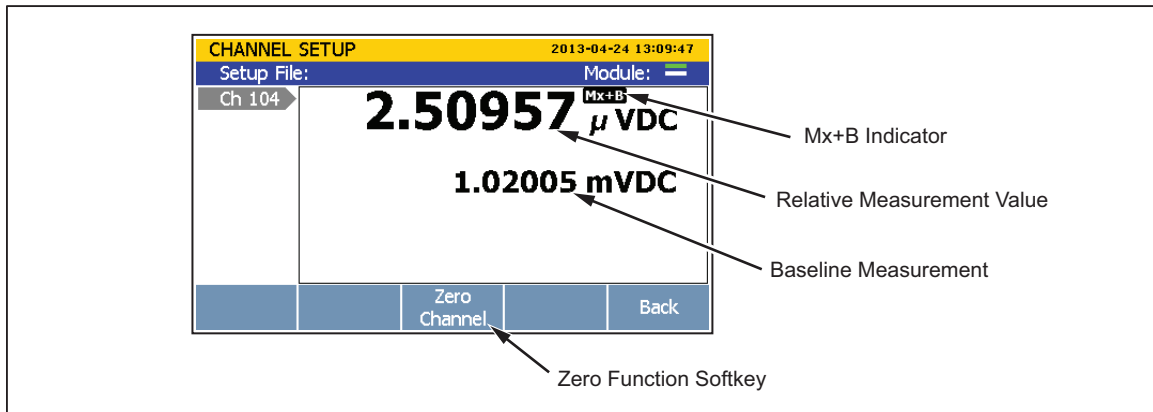

Figure 3-7. Zero Function

hcn060.eps

Copy a Channel



The Product has a copy and paste function to help duplicate channels. When a channel is duplicated, all of the channel configuration settings are copied and pasted to a new channel number. The copy channel softkey is located in the Channel Setup menu.

Note

When a channel is copied to another channel, the channel configuration of the target channel is overwritten without a notification. Confirm the channel selections before OK is pushed to prevent accidental overwrites.

To duplicate a channel with copy and paste:

1. Push **CHANNEL SETUP**.
2. Push **▼** or **▲** to highlight a channel.

3. Set the channel to **ON** if necessary.
4. Push **F3** to open the Copy Channel menu.
5. Use  or  to highlight a channel then push **F3** to select the channels to paste to.
6. Push **F4** to paste the channels.

Save or Load a Channel Configuration (Setup File)

The channel and test configuration can be saved to a file referred to as the Setup file. When the Setup file is saved, the Product saves the present configuration of each channel (including Mx+B and Alarms) in their current state (ON or OFF). Setup files can be loaded at a later time or transferred to another Product with a USB drive. Setup files are managed and loaded from the internal memory in the Memory menu.

Notes

- *Setup files cannot be directly saved to or loaded from the USB drive. To save Setup files to a USB drive, save the file to the internal memory, then copy it to the USB drive. To load a Setup file from a USB drive, copy the file to internal memory then load the file. See the instructions below.*
- *The Product will not load a Setup file if the present configuration does not match the configuration in the Setup file. This is caused by missing Input Modules. Match the configuration and try to load the Setup file again.*

To save a Setup File:

1. Push .
2. Push **F5**.
3. Follow the on-screen directions to name the file then push **F4** to save.

To save a Setup file to a USB drive:

1. Save the current Setup file to internal memory.
2. Insert a USB drive into the front-panel USB port.

Note

Wait about 15 seconds to let the Product recognize the USB drive. The LED illuminates solid red when the USB drive is recognized and ready.

3. Push .
4. Push **F1** to select **Internal Files**.

5. Choose **Setup Files** then push **F4**.
6. Use the **▼** and **▲** keys to select the file to be copied.
7. Push **F3** to manage the file.
8. Push **F1** to copy to the USB drive.

Note

Do not remove the USB drive until you see a file transfer complete message.

To load a Setup File:

1. Push **MEMORY**.
2. Push **F1** to select internal files.
3. Select **Setup Files** then push **F4**.
4. Use **▼** and **▲** to highlight the Setup File.
5. Push **F2** to load and use the Setup File.

To load a Setup File from a USB drive:

1. Insert a USB drive into the front-panel USB port.

Note

Wait 15 seconds to let the Product recognize the USB drive.

2. Push **MEMORY**.
3. Push **F2** to select **USB Files**.
4. Choose **Setup Files** then push **F4**.
5. Use the **▼** and **▲** keys to select the file to be copied.
6. Push **F3** to manage the file.
7. Push **F1** to copy to the internal memory.

Note



Do not remove the USB drive until you see a file transfer complete message.

Reset the Channel and Test Configuration

To reset the entire channel configuration and test setup:

Note

All channels are set to the default settings when reset and cannot be restored unless the configuration was saved.

1. Push and hold  for 3 seconds.
2. Push  to confirm to reset channel setup, or push  to cancel.





Analog Channel Configuration (Ch001, Ch101 to Ch222)

After an analog input is connected to the Input Module and/or the front-panel connectors, the channel must be configured for the type of input that is connected. Analog inputs are channels Ch101 to Ch122 and Ch201 to Ch222. Use the procedure below and the tables in this section to set up channels for specific input types.

Please read the considerations below to help with channel configuration:

- For new channels that have not been previously set up, the user is prompted to configure the channel when it is set to ON for the first time. Push the cancel softkey () while in the setup sequence to: (1) accept the default settings for new channels or (2) use the previous configuration for channels previously configured.
- A channel can be configured with the Edit Channel softkey in the Channel Setup menu.
- Each channel has independent channel options such as Channel Delay, Rate of Change, Display As reading type, and thermocouple open-circuit detect that can be accessed with the Channel Options softkey in the Edit Channel menu. The channel options listed vary based on the on the input type.
- After a channel is configured, it is important to verify the channel with the Verify Channel softkey on the Channel Setup menu. This ensures that the channel was configured properly before data is collected from a scan. See “Verify a Channel” on page 3-14.

To configure an analog channel:

1. Push .
2. Set the channel to ON (see “Set Channels to ON or OFF” on page 3-12). When the channel is set to ON, a channel configuration sequence shows on the display that steps the user through an initial configuration sequence as shown in Table 3-5. If the channel was previously configured, push  to cancel the configuration sequence to use the last channel configuration.
3. Use the information in the tables in this section to configure the channel. Push  or  to highlight the channel setting then push  to edit the setting.

4. After the channel is configured, verify that the channel is configured properly and reading the input. For instructions, see “Verify a Channel” on page 3-14.

Current and Voltage Channels

Refer to Table 3-4 to configure a dc voltage or current channel.

Note

Ch001 can be set up for all measurements. ChX21 and ChX22 are the only channels that can be set up for current measurements. To expand the functionality of the Product, current sources can also be connected to ChX01 through ChX20 by the use of an accessory shunt resistor. See Chapter 2 for part number and ordering information.

Table 3-4. Current and Voltage Channel Configuration

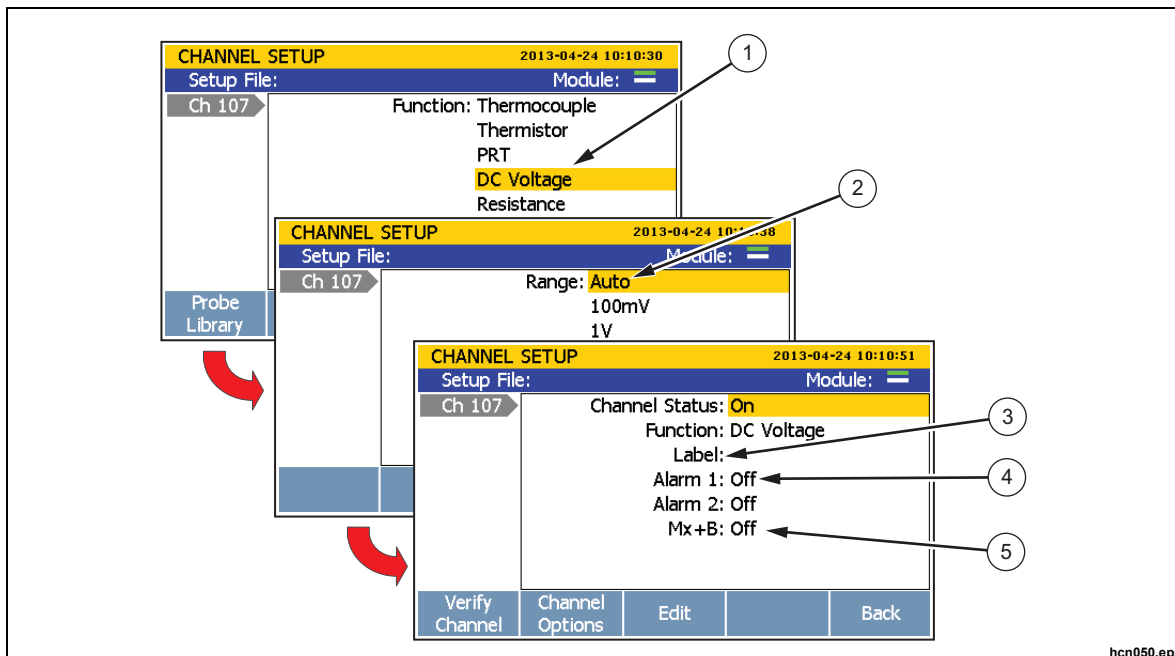

| Item | Function |
|------|--|
| ① | DC voltage or DC current function selection. |
| ② | For voltage, set the voltage range to: Auto, 100 mV, 1 V, 10 V, or 50 V. For current, set the current range to: Auto, 100 μ A, 1 mA, 10mA, or 100 mA. |
| ③ | Input a custom alpha-numeric label to help identify the channel (optional). |
| ④ | Set an alarm for this channel (optional). See “HI and LO Channel Alarms” on page 3-31. |
| ⑤ | Apply Mx+B scaling to the measurement (optional). See “Mx+B Scaling” on page 3-30. |

Resistance Channels

Refer to Table 3-5 to configure a resistance channel.

Table 3-5. Resistance Channel Configuration

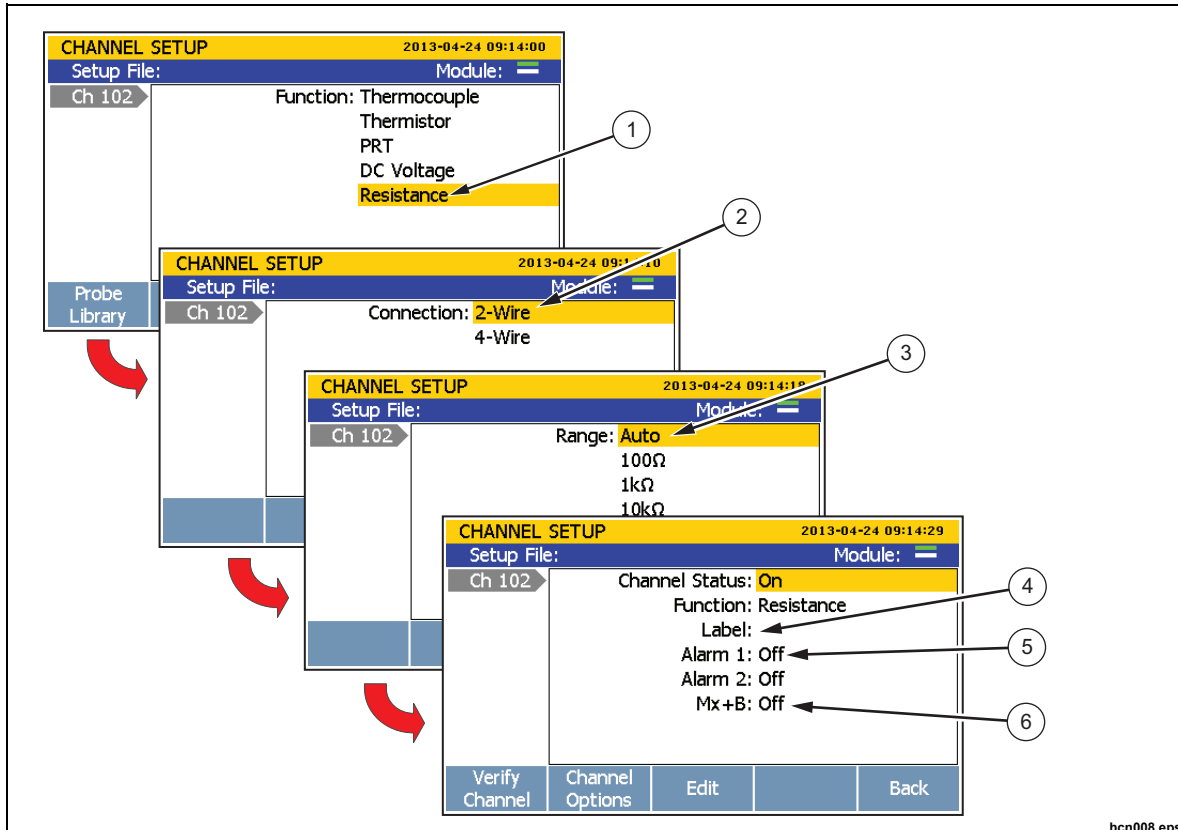

hcn008.eps

| Item | Function |
|------|---|
| ① | Resistance function selection. |
| ② | Set up the channel for a 2-wire or 4-wire resistance measurement connection. See “Sense Input Configuration” on page 3-6. |
| ③ | Set the range to: Auto, 100 Ω, 1 kΩ, 10 kΩ, 100 kΩ, 1 MΩ or 10 MΩ. Ch001 can be set to 100 MΩ. |
| ④ | Input a custom alpha-numeric label to help identify the channel (optional). |
| ⑤ | Set an alarm for this channel (optional). See “HI and LO Channel Alarms” on page 3-31. |
| ⑥ | Apply Mx+B scaling to the measurement (optional). See “Mx+B Scaling” on page 3-30. |

Thermocouple Channels

Refer to Table 3-6 to configure a thermocouple channel. Thermocouple types R and S have optional correction polynomial coefficients to be entered. The correction equation is as follows:

$$\Delta V = C0 + C1t + C2t^2 + C3t^3$$

where t is the temperature in °C and ΔV is the correction in millivolts. If the correction is not used, leave the coefficients set to 0.

Table 3-6. Thermocouple Channel Configuration

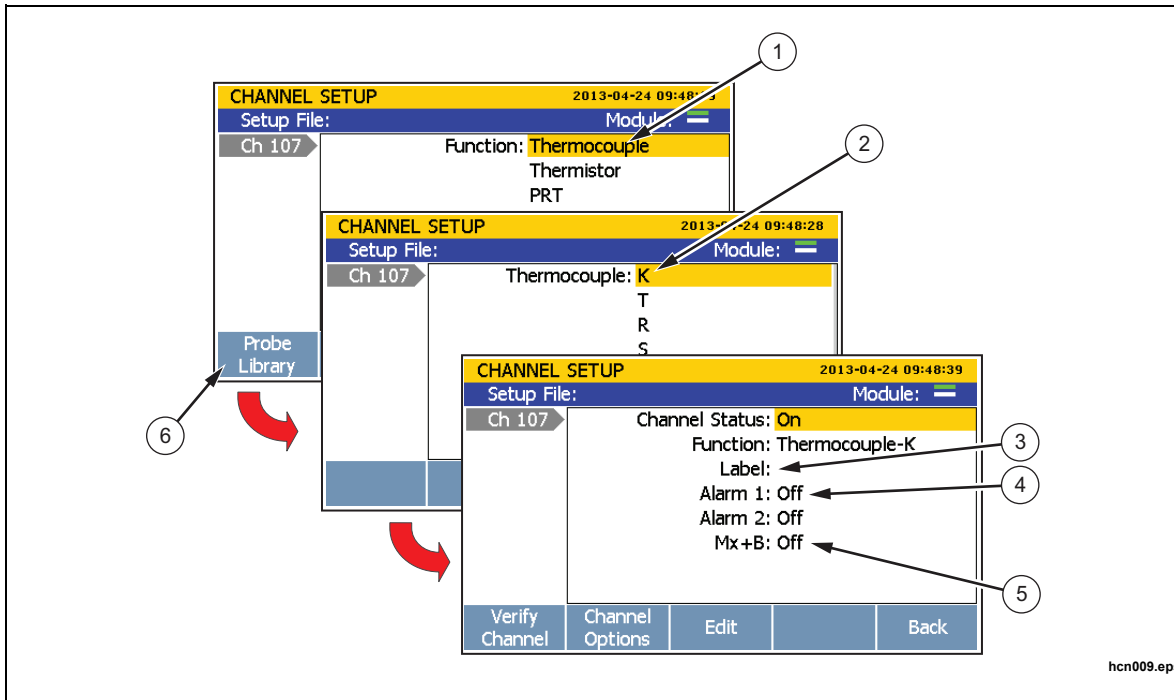

| Item | Function |
|------|--|
| ① | Thermocouple function selection. |
| ② | Select the thermocouple type. |
| ③ | Input a custom alpha-numeric label to help identify the channel (optional). |
| ④ | Set an alarm for this channel (optional). See “HI and LO Channel Alarms” on page 3-31. |
| ⑤ | Apply Mx+B scaling to the measurement (optional). See “Mx+B Scaling” on page 3-30. |
| ⑥ | Load a thermocouple from the Probe Library. See “Probe Library” on page 3-34. |

Thermistor Channels

Refer to Table 3-7 to configure a thermistor channel. The R(T) polynomial type requires polynomial coefficients to be entered. The thermistor characterization polynomial is as follows:

$$x = \frac{1}{t + 273.15}$$

$$y = B0 + B1 x + B2 x^2 + B3 x^3$$

$$R = \exp y$$

Where t is the temperature in °C and R is the resistance in Ω. Any coefficients that are not used must be set to 0.

Table 3-7. Thermistor Channel Setup

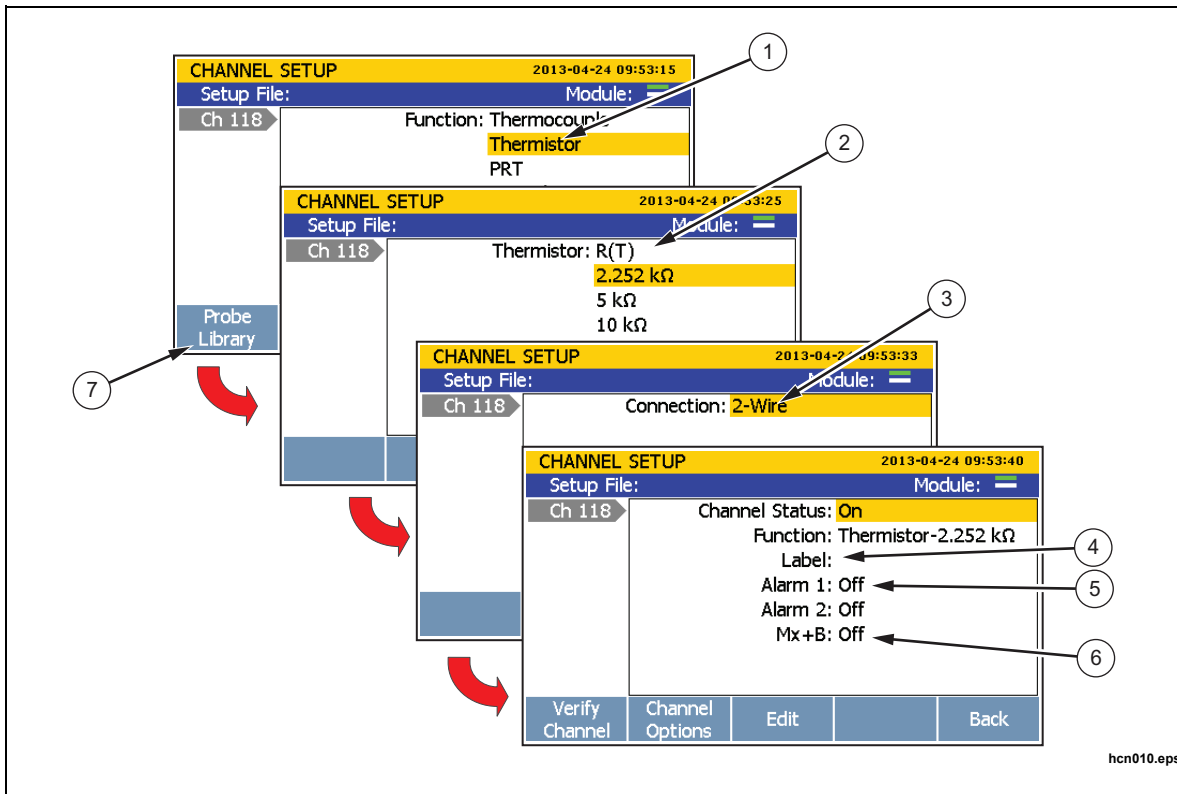

| Item | Function |
|------|--|
| ① | Thermistor function selection. |
| ② | Select the thermistor type. Types available: R(T), 2.252 kΩ, 5 kΩ, and 10 kΩ. |
| ③ | Set up the channel for a 2-wire measurement connection. See “Sense Input Configuration” on page 3-6. |
| ④ | Input a custom alpha-numeric label to help identify the channel (optional). |
| ⑤ | Set an alarm for this channel (optional). See “HI and LO Channel Alarms” on page 3-31. |
| ⑥ | Apply Mx+B scaling to the measurement (optional). See “Mx+B Scaling” on page 3-30. |
| ⑦ | Load a thermistor from the Probe Library. See “Probe Library” on page 3-34. |

PRT Channels

Refer to Table 3-8 to configure a Platinum Resistance Thermometer (PRT) channel. ITS-90 type requires deviation function coefficients to be entered. Coefficient "A" should be set to the value of "a7" or "a8" as shown on the PRT calibration certificate. Likewise, "B" is for "b7" or "b8" and "C" is for "c7". If a coefficient is not available, it must be set to "0".

Table 3-8. PRT Channel Setup

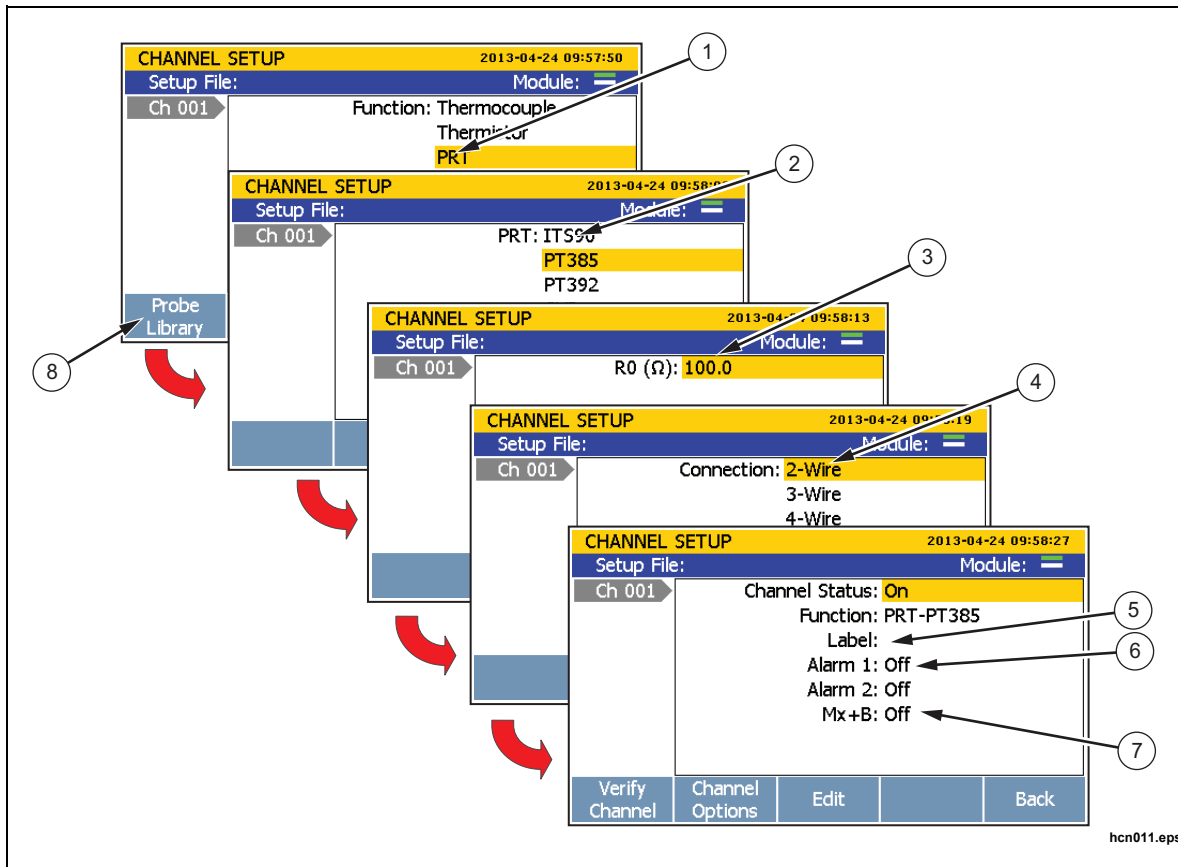

| Item | Function |
|------|---|
| ① | PRT function selection. |
| ② | Select the PRT type. Types available: ITS90, CVD, PT-385, and PT-392. |
| ③ | Set the PRT resistance value at 0 °C (CVD, PT-385, or PT-392) or 0.01 °C (ITS-90). |
| ④ | Set up the channel for a 2-wire, 3-wire, or 4-wire measurement connection. See "Sense Input Configuration" on page 3-6. |
| ⑤ | Input a custom alpha-numeric label to help identify the channel (optional). |
| ⑥ | Set an alarm for this channel (optional). See "HI and LO Channel Alarms" on page 3-31. |
| ⑦ | Apply Mx+B scaling to the measurement (optional). See "Mx+B Scaling" on page 3-30. |
| ⑧ | Load a PRT from the Probe Library. See "Probe Library" on page 3-34. |

Digital I/O (DIO) Channel Configuration (Ch401)

The Product can sense and output a digital, 8-bit transistor-transistor logic (TTL) value that can be displayed as the 8-bit TTL value and be recorded as the decimal equivalent. This is accomplished with the rear-panel digital I/O connectors (DIO) that are shown in Figure 3-8.

When a DIO input is sensed, the Product displays the status of the digital I/O as 8-bit TTL value and records the decimal equivalent. The 8-bit TTL value can also be seen when a channel is monitored. The default value is a high state that shows as “11111111” until the Product senses a low state or is used as an output. A few examples of some 8-bit TTL values and their decimal equivalents are shown below:

- 11111111 is represented by decimal 255
- 00001111 is represented by decimal 15
- 00010001 is represented by decimal 17
- 10000101 is represented by decimal 133

Notes

For input and output specifications such as input and output voltages, see “Digital I/O” in Chapter 1.

The DIO channel will be read-only when it is set to ON (active).

With a remote command, the Product can output an 8-bit TTL value. See the *1586A Remote Programmers Guide* for more information.

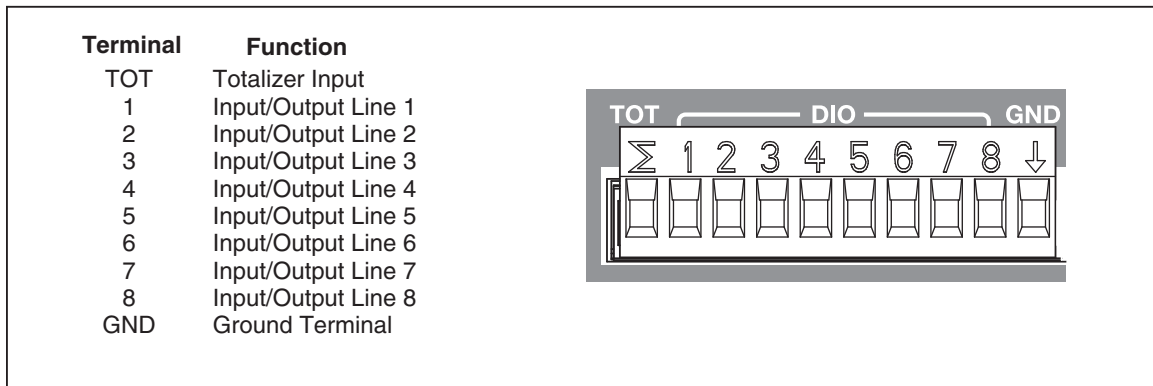



Figure 3-8. DIO Connector

hcn019.eps

Set up the DIO channel as follows:

1. Connect the equipment to the DIO input terminal then insert it into the rear-panel digital I/O (DIO) port.
2. Push .

3. Set channel 401 to ON (see “Set Channels to ON or OFF” on page 3-13).
4. Assign a label to the channel if desired.
5. To measure the DIO, monitor channel Ch401 in the Scan/Monitor menu. The 8-bit TTL value is shown on the display and the decimal equivalent will be recorded to the data file.

Totalizer Channel Configuration (Ch402)

The Product is equipped with a unidirectional, resettable totalizer with an input count capability of 0 to 1048575 (20 bits). When a digital input is connected to the TOT input on the rear panel and Ch402 is set to on, the Product counts each time the dc voltage of the signal transitions from high to low or a contact closes to the ground (GND). When a scan is started, the TOT counter is reset to 0. The totalizer count can be manually reset at any time with **F2** in the Scan menu.

Read Mode

The totalizer function has two read modes: read and read/reset. The mode can be set in Channel Setup or by remote command. The default totalizer mode is read.

In read mode, the count is not effected when read during the scan sweep or read by remote command.

In read/reset mode, the totalizer count is automatically reset to 0 when it is read during a scan sweep or read by remote command. It is not effected by pause scan. The totalizer count is not reset when it is viewed with the Monitor function.

Debounce

In some applications, contacts can “bounce” when they close that results in multiple signals on one line. Without a filter the Product detects multiple closures that can cause duplicate counts for one closure. To filter the signal, the Product has a debounce feature that can detect bounce on the signal and ignore it. Debounce (600 Hz) can be turned on with the Edit channel function of the Totalizer channel (Ch402). If the debounce feature is disabled, 10 kHz is the maximum frequency the Totalizer input can support.

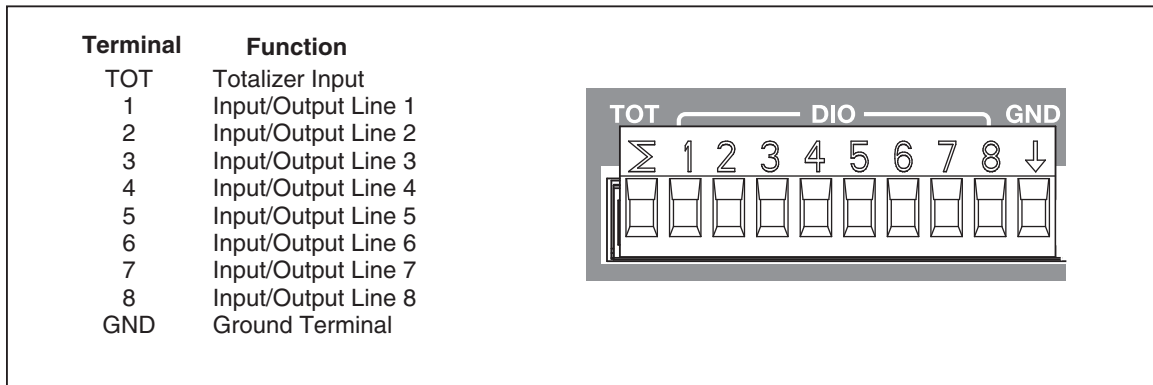

Figure 3-9. Totalizer Input (TOT)

hcn019.eps

Set up a totalizer channel as follows (see Table 3-9):

1. Connect the wire to the TOT terminal of the plug then insert the plug into the rear-panel DIO/TOT port.
2. Set the channel to ON (see “Set Channels to ON or OFF” on page 3-12). When the channel is set to ON, a channel configuration sequence shows on the display that steps the user through an initial configuration sequence as shown in Table 3-9. If the channel was previously configured, push **F5** to cancel the configuration sequence to use the last channel configuration.
3. Use the information in Table 3-9 to configure the totalizer channel. Push **▼** or **▲** to highlight the channel setting then push **F3** to edit the setting.
4. To see the totalizer count, monitor Ch402 in the Scan/Monitor menu.

Table 3-9. Totalizer Channel Configuration

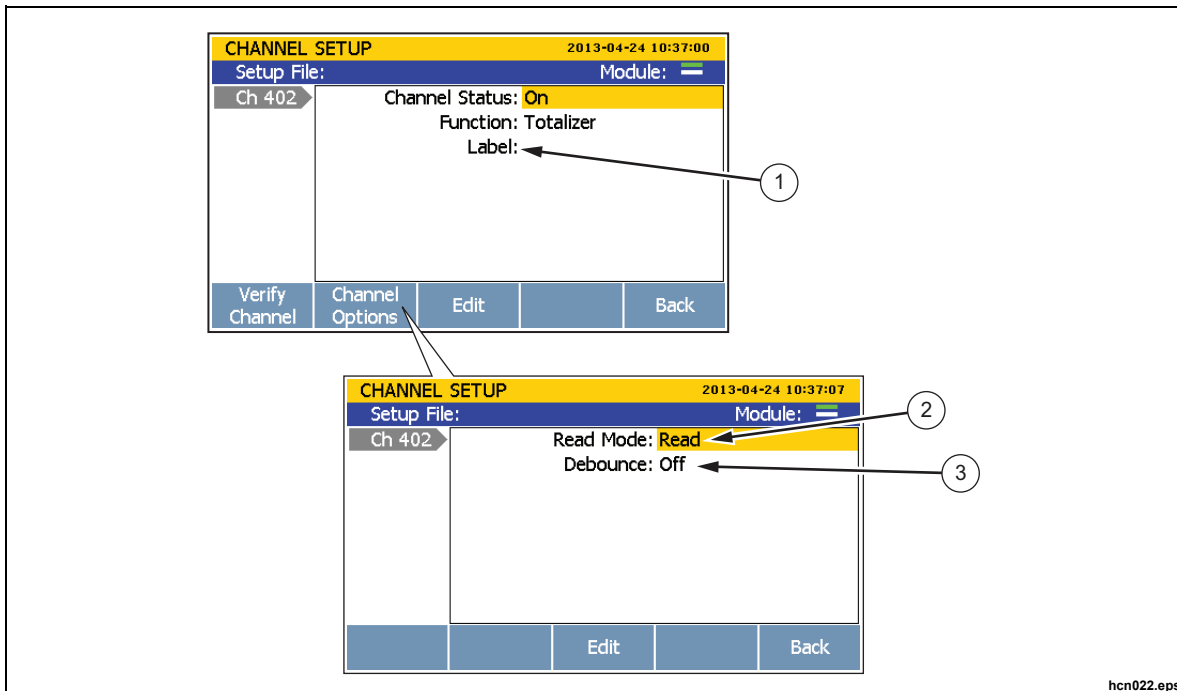

hcn022.eps

| Item | Function |
|------|---|
| ① | Input a custom alpha-numeric label to help identify the channel (optional). |
| ② | Read mode selection. See “Read Mode” on page 3-25. |
| ③ | Set the Debounce feature to ON or OFF. See “Debounce” on page 3-25. |

Math Channel Configuration (Ch501 to Ch520)

The Product has 20 math channels that lets the user apply a math conversion to a single channel or to a range of channels through the use of preset math functions. Table 3-10 lists the math functions available for use.

Math channels are commonly used to combine the measurement values then display them as one number without the need to manually calculate the values. Like all other channels, math channels can be scanned and recorded.

Another use of the math channels is to apply a math conversion to a single channel that is more advanced than Mx+B scaling. For example, a more accurate conversion of an output of a transducer to a physical parameter.

More complicated expressions can be made with a math channel that uses the calculations from two other math channels. For example, a math channel could be configured to calculate the exponential function of another math channel that is configured to calculate a polynomial function of an input channel.

Table 3-10. Math Channel Formulas

| Formula | Equation | Description |
|-------------|---|--|
| Polynomial | $C_6A^6 + C_5A^5 + C_4A^4 + C_3A^3 + C_2A^2 + C_1A + C_0$ | Calculates a polynomial expression of up to sixth order. Coefficients may be set to arbitrary constants. A polynomial of order less than six is created by setting high order coefficients to 0. |
| Square Root | \sqrt{A} | Calculates the square root function. The argument must be a positive number, otherwise the result will be "+OL" (over limit). |
| Power | A^x | Calculates the power of the variable. The exponent can be a noninteger number but the result will be "+OL" if the argument is negative. |
| Exponential | e^A | Calculates the exponential function of a variable, where e is 2.718. |
| Log10 | Log10(A) | Calculates the logarithm, base 10, of a variable. The argument must be positive or the result will be "+OL". This formula is helpful when used with an Mx+B scale factor of 20 to convert a reading to decibels. |
| A | ABS(A) | Calculates the absolute value of a variable, converting a value to a positive number if it happens to be negative. The absolute value function can be useful to ensure that the argument to another math channel is always positive. |

Table 3-10. Math Channel Formulas (cont.)

| Formula | Equation | Description |
|---|-----------------------------|--|
| 1 / A | 1 / A | Calculates the reciprocal of a variable. The argument cannot be 0 or the result will be "+OL". |
| A + B | A + B | Adds the readings of two source channels. This is useful to create expressions of more than one independent variable. |
| A – B | A – B | Calculates the difference between readings of two source channels. |
| A x B | A x B | Multiplies the readings of two source channels. This can be useful for calculating electric power from a voltage reading on one channel and a current reading on another channel. |
| A / B | A / B | Divides the reading of one source channel by the reading of another channel. This can be useful for observing the ratio of two related parameters. The argument cannot be 0 or the result will be "+OL". |
| Average ^[1] | $\frac{A1 + A2 + A3...}{N}$ | Calculates the arithmetic mean of the readings of selected channels. |
| Maximum ^[1] | N/A | Finds the maximum reading among selected channels. |
| Minimum ^[1] | N/A | Finds the minimum reading among selected channels. |
| Sum ^[1] | A1 + A2 + A3... | Calculates the sum of the readings of selected channels. |
| Note | | |
| [1] - Maximum of 10 channels can be calculated. | | |

Set up a math channel as follows (see Table 3-11):



1. Connect and configure the channel or channels to apply the math formula to.
2. Set the channel to ON (see “Set Channels to ON or OFF” on page 3-12). When the channel is set to ON, a channel configuration sequence shows on the display that steps the user through an initial configuration sequence as shown in Table 3-11. If the channel was previously configured, push **F5** to cancel the configuration sequence to use the last channel configuration.
3. Use the information in the Table 3-11 to configure the math channel. Push  or  to highlight the channel setting then push **F3** to edit the setting.

Table 3-11. Math Channel Configuration



| Item | Function |
|------|--|
| ① | Math formula selection. |
| ② | Channel selection for the first base channel "A". |
| ③ | Channel selection for the second base channel "B". <i>Note</i> Only channels "A" and "B" are shown in the example because the sum math formula only combines two channels. Some formulas have only one source channel while some others allow more than two source channels. |
| ④ | Set the unique unit to be associated with the measurement value. |
| ⑤ | Input a custom alpha-numeric label to help identify the channel (optional). |
| ⑥ | Set an alarm for this channel (optional). See "HI and LO Channel Alarms" on page 3-31. |
| ⑦ | Apply Mx+B scaling to the measurement (optional). See "Mx+B Scaling" on page 3-30. |

Mx+B, Alarms, and Channel Options

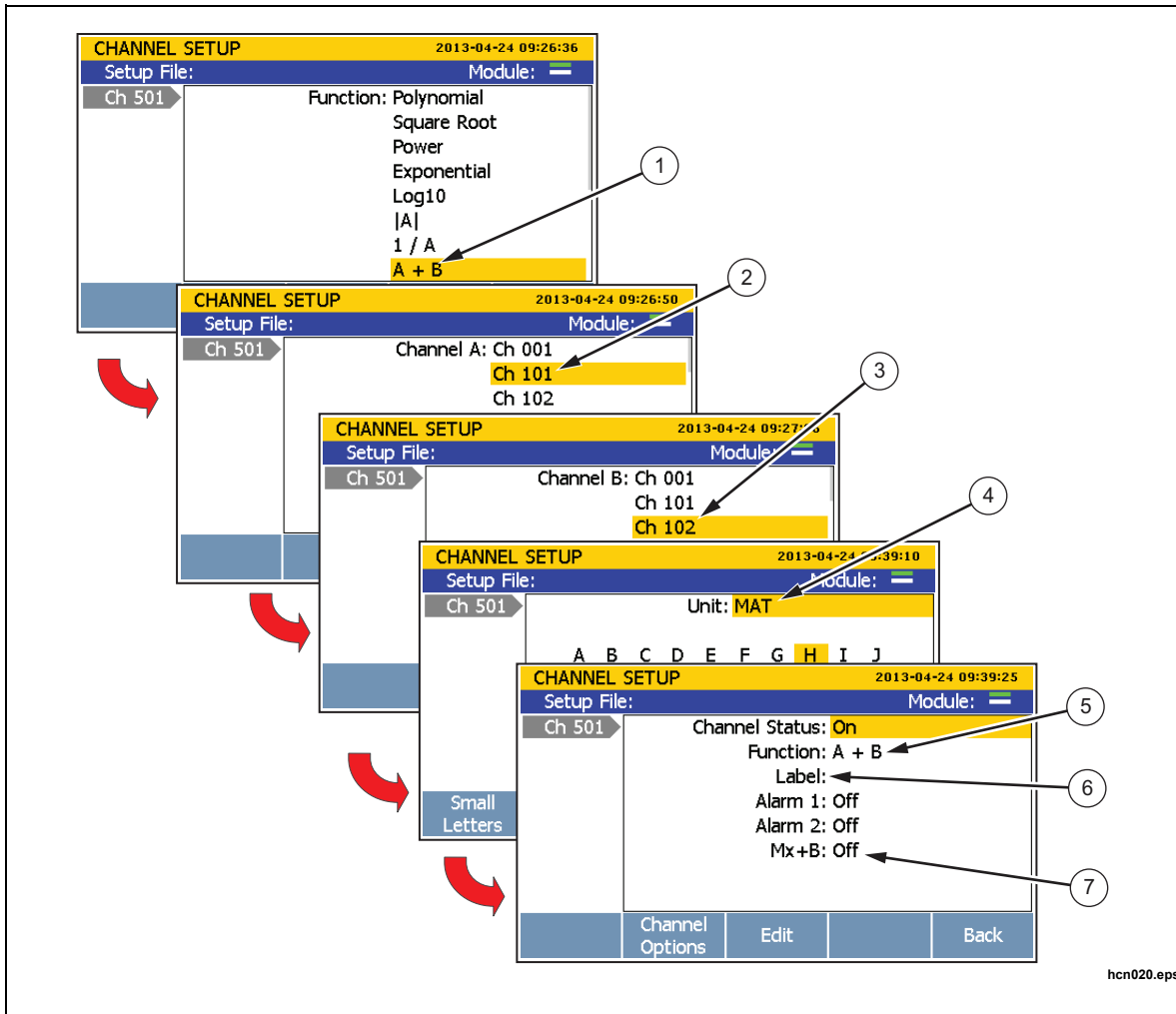
The subsequent sections supply information and procedures on how to apply Mx+B scaling, set up channel alarms, and configure additional channel options.

Mx+B Scaling

Mx+B is a calculation that can be applied to a channel to scale a measurement value. This feature is useful in applications where an input measurement needs to be converted to a different unit or value to simulate an output. Common scaling conversions are:

- Scaling of a milliamp output of a pressure transducer to the equivalent kPa or psi value.
- Scaling of a temperature reading from degrees Celsius to kelvins.
- Conversion of shunt resistor voltage to current in amperes.

To calculate Mx+B, the "M" value is referred to as the "gain" and is used as a multiplier of the actual reading. After the gain is calculated, the "B" value or the "offset" is added to the resultant.

For example, if a channel measures a voltage of 3 volts and the gain was set to 3.3, the measurement on the display would read 9.9 volts ($3 \text{ V} * 3.3 \text{ gain} = 9.9 \text{ V}$). Now the offset is added to the gain. If the offset was set to 11.0, it would be added to the 9.9 volts and the display would read 20.9 volts ($9.9 \text{ V} + 11.0 \text{ offset} = 20.9 \text{ V}$).

More examples:

$(6.9 \text{ gain} * 20 \text{ mA}) + 16.0 \text{ offset} = 154 \text{ kPa}$

$(1.0 \text{ gain} * 25.0 \text{ }^\circ\text{C}) + 273.15 \text{ offset} = 298.15 \text{ K}$

$(10.0 \text{ gain} * 0.32 \text{ V}) + 0.0 \text{ offset} = 3.2 \text{ A}$







If necessary, the Mx+B menu lets the user designate a new unit to accurately represent the scaled measurement. This unit shows on the display and in the recorded scan data as long as Mx+B is set to ON. If the Mx+B is set to OFF, the unit reverts back to the original unit. When a channel has Mx+B scaling applied, a [Mx+B] icon is shown above the unit next to the measurement value.

Note

If the scaled value is too large, "OL" (overload) is displayed. Adjust the gain or the offset and try again.

The Product uses the offset to zero a channel. To do this, the Product calculates the offset required to convert the measurement to a zero value, sets Mx+B to ON, and loads the calculated offset value into the Mx+B settings. To clear the zero, the offset value can be manually set back to the original value (usually “0”) or Mx+B can be set to OFF if it was off before the channel was zeroed. See “Zero a Channel” on page 3-14 for instructions on how to zero a channel.

To apply an Mx+B scaling to a channel:









1. Push .
2. Push  or  to highlight a channel.
3. Set the channel to **ON** if necessary.
4. Push  to edit the channel.
5. Select Mx+B and push .
6. Input the Gain and Offset values and set the unit as desired. When complete, push  to return to the previous menu.
7. Verify the channel. If the scaled channel gives unexpected results (like zero or “OL”):
 - Verify that the correct gain and offset values are set.
 - Manually calculate the result with the entered gain and offset values. See the examples in this section.
 - Temporarily set the gain to 1 and the offset to 0 to verify that the measurements are in the expected range. Unexpected measurements could result from a wiring error or the wrong range or function selected.

HI and LO Channel Alarms

Each channel has two channel alarms that can have custom values assigned to trip when a channel measurement exceeds the assigned high (HI) or low (LO) limit. If an alarm trips, the measurement value on the display changes to red and will stay red until the measurement is back in the normal range.

In addition to the visual indication, the channel alarm can be tied to one of the six alarm outputs on the rear panel (see Figure 3-10 and Figure 3-11). An alarm output can have multiple channels assigned to it. If an alarm trips, the alarm outputs a low condition signal (<0.7 V dc). A common use of this feature is to connect to an external audio alarm that will sound if the channel alarm is tripped.

To set a channel alarm:

1. Push .
2. Push  or  to highlight a channel then push .
3. Push  or  to highlight **Alarm** then push .
4. Select **Alarm 1** or **Alarm 2** then push .

5. Highlight **High** or **Low** then push **F4**.
6. Use the numeric keypad to input the limit (**Setpoint**).
7. To turn on an alarm output:
 - a. Highlight **Output** the then push **F3**.
 - b. Highlight an alarm output to assign to the channel then push **F4**.

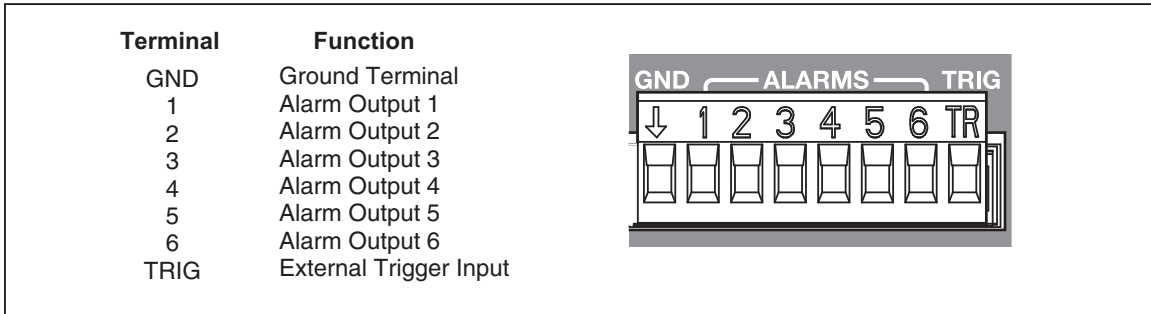

Figure 3-10. Rear-Panel Alarm Outputs

hcn049.eps

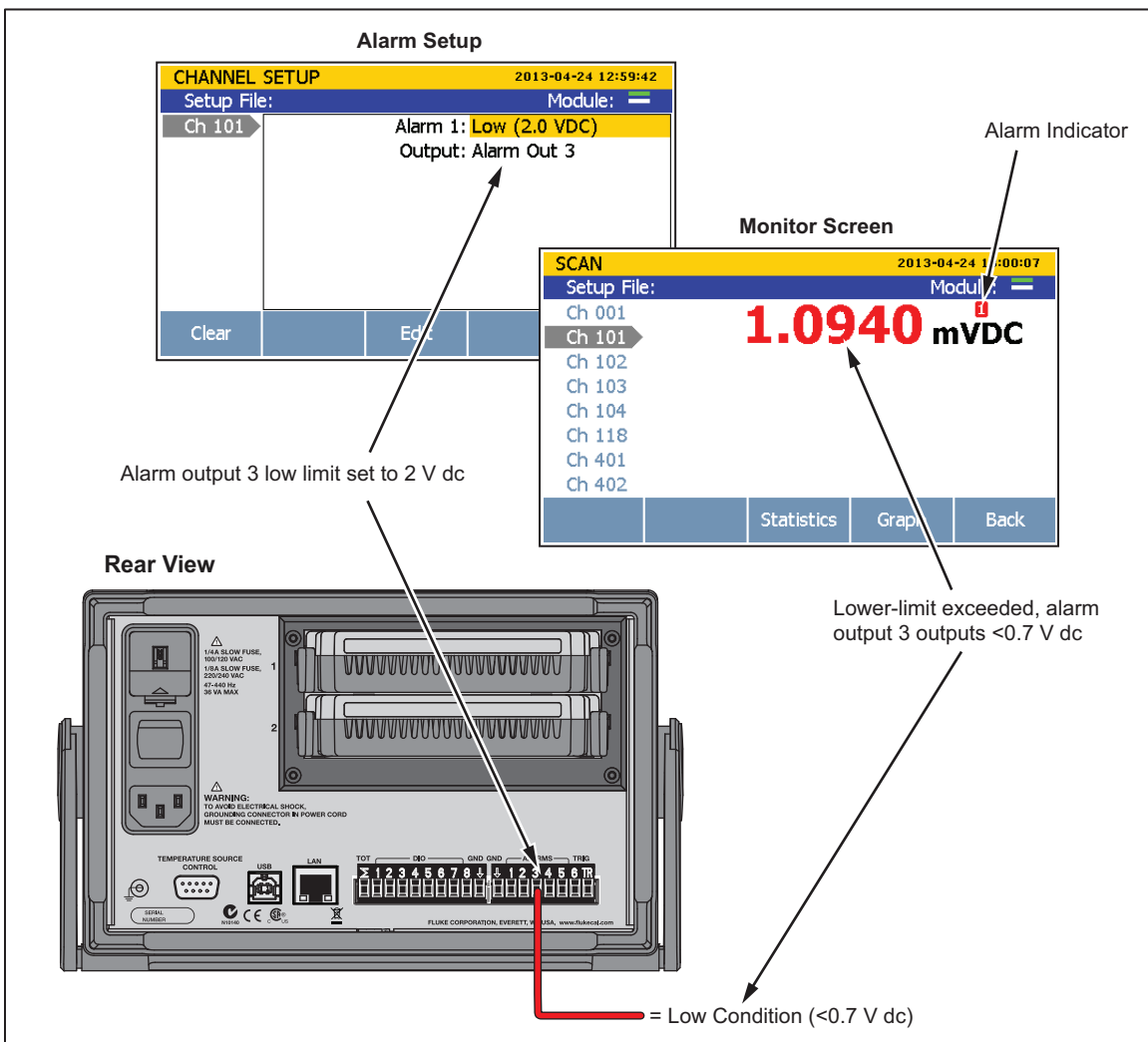

Figure 3-11. Alarm Output Example







hcn041.eps

Channel Delay

A channel delay is a measurement time delay that can be individually assigned to each channel to delay the measurement. Channel delays can be used for various applications, but they are most useful in applications where the source impedance or circuit capacitance is high. Use of a channel delay in these applications allow the input signal to settle before a measurement is made. This provides better measurement accuracy.

When a channel delay is set, the Product inserts the delay after the channel relays switch and waits until the channel delay time runs out before it measures the channel. Channel delays are set in seconds and the default setting is 0 seconds.

To set a channel delay:

1. Push .
2. Push  or  to highlight a channel then push .
3. Push  to open the Channel Options menu.
4. Select **Channel Delay** then push .
5. Set the custom channel delay. The delay can be manually set in 1 millisecond increments from 1 millisecond to 600 seconds.

Rate of Change

Rate of Change is a statistical calculation that shows the user how much a measurement value has changed over a period of time. The Rate of Change is viewed in the statistics/graphing area in the Scan Menu. The Rate of Change setting in the Channel Options menu sets the scaling to per second (/s) or per minute (/min).

Note







Per minute (/min) is the default scaling selection unless otherwise changed.

To determine the rate of change, the Product compares two readings of a channel sampled at different times. First, the product computes the difference between the two readings and then divides it by the time difference between the samples in seconds. The result is then multiplied by the time base in seconds (60 for per minute) to determine the Rate of Change.

Note

If a channel is sampled more frequently than once every 10 seconds, two readings about 10 seconds apart are selected. If the interval between readings is 10 seconds or longer, the latest two readings are used.

To change the Rate of Change time base for a channel:

1. Push .
2. Push  or  to highlight a channel then push .
3. Push  to open the Channel Options menu.
4. Select **Rate of Change** then push .
5. Select per second or per minute then push .

Display As

Located in the Channel Options menu, use this setting to change the type of measurement of a temperature sensor. Available options change with the channel type selected.

Selections available:

- temperature or the compensated mV equivalent for thermocouple channels.
- temperature or resistance for PRT and thermistor channels.

Open Detect

Located in the Channel Options menu, this setting enables the Product to automatically detect an open circuit in the probe. This setting only shows in a thermocouple channel.

Probe Library

The Probe Library lets users quickly load and save thermistors, thermocouples, and PRTs along with their coefficients to memory. Through the Probe Library menu, users can input new probes, change probes, and assign the probes to a channel. The Probe Library can be accessed with **F1** when editing the function of a channel. See Figure 3-12.

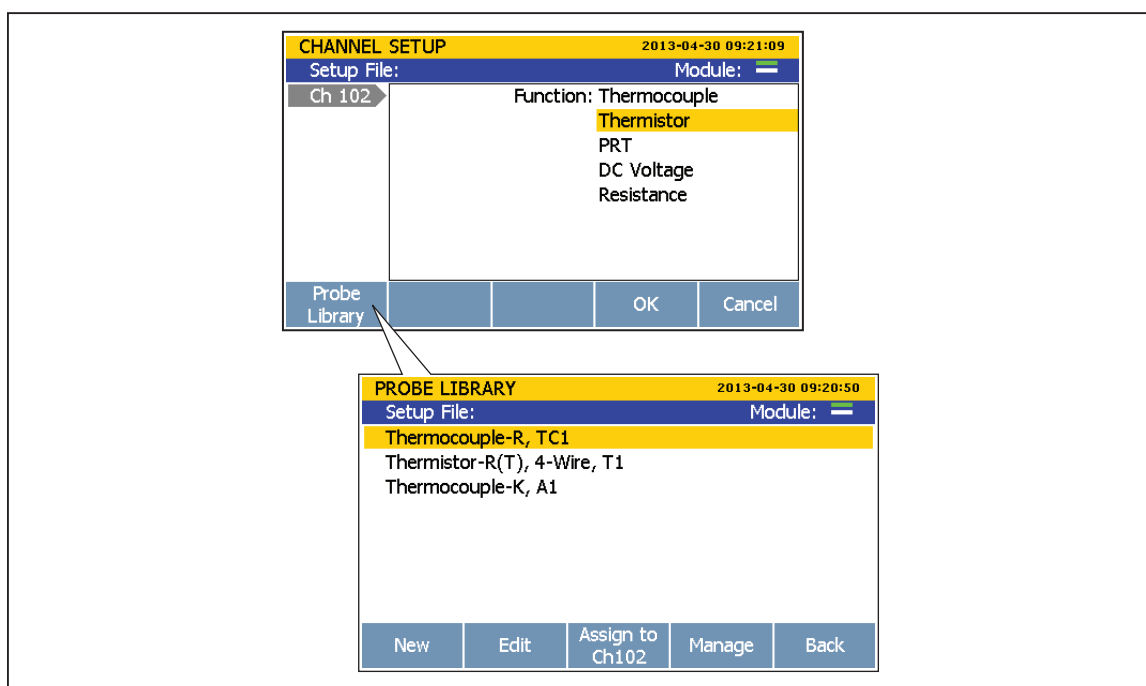

Figure 3-12. The Probe Library

hcn069.eps

To input a new probe:

1. Push **CHANNEL SETUP**.
2. Push **▼** or **▲** to highlight a channel then push **F1**.
3. Push **▼** or **▲** to select Function then push **F3**.
4. Push **F1** to open the Probe Library.

5. Push **F1** to input a new probe.
6. Select Label and push **F3** to set a custom label or push **F1** to read the label from the channel.
7. Select Function and push **F3** to change. Use the on-screen options to configure the probe.
8. After the function and label is set, push **F4** to save.

To edit a probe:

1. Push **CHANNEL SETUP**.
2. Push **▼** or **▲** to highlight a channel then push **F1**.
3. Push **▼** or **▲** to select Function then push **F3**.
4. Push **F1** to open the Probe Library.
5. Push **▼** or **▲** to highlight a probe in the list then push **F2** to edit.
6. Select Label and push **F3** to change the label.
7. Select Function and push **F3** to change. Use the on-screen options to configure the probe.
8. After the function and label is set, push **F4** to save the changes.

Assign a probe to a channel:

1. Push **CHANNEL SETUP**.
2. Push **▼** or **▲** to highlight a channel then push **F1**.
3. Push **▼** or **▲** to select Function then push **F3**.
4. Push **F1** to open the Probe Library.
5. Push **▼** or **▲** to highlight a probe in the list then push **F3** to assign it to the channel shown.

Chapter 4

Scan/Monitor, Record, and Data

| | Title | Page |
|--|--------------|-------------|
| Introduction..... | | 4-3 |
| Scan..... | | 4-3 |
| About Scan Timing and Sampling..... | | 4-5 |
| Configure a Scan | | 4-6 |
| Trigger Type..... | | 4-7 |
| Auto Recording..... | | 4-8 |
| File Destination | | 4-8 |
| Sample Rate | | 4-8 |
| Data Security..... | | 4-9 |
| Temperature Unit | | 4-10 |
| Align Channels..... | | 4-10 |
| Automatic Power Loss Scan Resume..... | | 4-11 |
| Basic Scan Procedures..... | | 4-11 |
| Start a Scan..... | | 4-11 |
| View Scan Data and Statistics..... | | 4-12 |
| Graph the Measurements..... | | 4-14 |
| Monitor | | 4-15 |
| Automated Test..... | | 4-16 |
| Overview | | 4-16 |
| Configure an Automated Test..... | | 4-17 |
| Connect to An External Source | | 4-18 |
| Record..... | | 4-19 |
| Record Measurement Data | | 4-19 |
| Memory Consumption for Recorded Data | | 4-20 |
| Open and View Measurement Data on a PC | | 4-20 |
| How to Read the Setup CSV File | | 4-22 |
| How to Read the Data CSV File..... | | 4-24 |

Introduction

This chapter supplies information on the Scan, Monitor, and Record functions along with procedures and instructions.

Scan

Scan is a function of the Product that sequentially measures each channel and either temporarily shows the data on the display or records it to file if the recording feature is enabled (see “Record” on page 4-16). Scans are started manually by the user or by an internal or external trigger. To scan a channel, the Product sequentially cycles through the channels that are active and makes measurements as directed by the Test Setup file (see “Configure a Scan” on page 4-6).

Note

Monitor is a function to see the measurement data from a single channel while a scan is in progress (see “Monitor” on page 4-15). Use of the monitor function does not interrupt the active scan and only shows the measurement data from the last scan cycle completed.

In order for the Product to scan, the applicable channels need to be active and the unit under test (UUT) must be connected and ready. After these steps are complete, a scan can be started from the Scan/Monitor menu. If “Auto Recording” in the Test Setup menu is set to ON, the Product automatically records the scan data when the scan is started. If set to OFF, the user must manually push the Record key () to record the measurement data to file. The scan data is stored to memory where it can be transferred to a PC to be viewed with Microsoft Excel (see “Open and View Measurement Data on a PC” on page 4-20).

While a scan is in progress, the measurements and statistics for all channels can be viewed in a chart or in a graph without interruption to the scan (see Figure 4-4). After a scan is stopped, this scan data stays in temporary memory and remains available until a new scan is started.

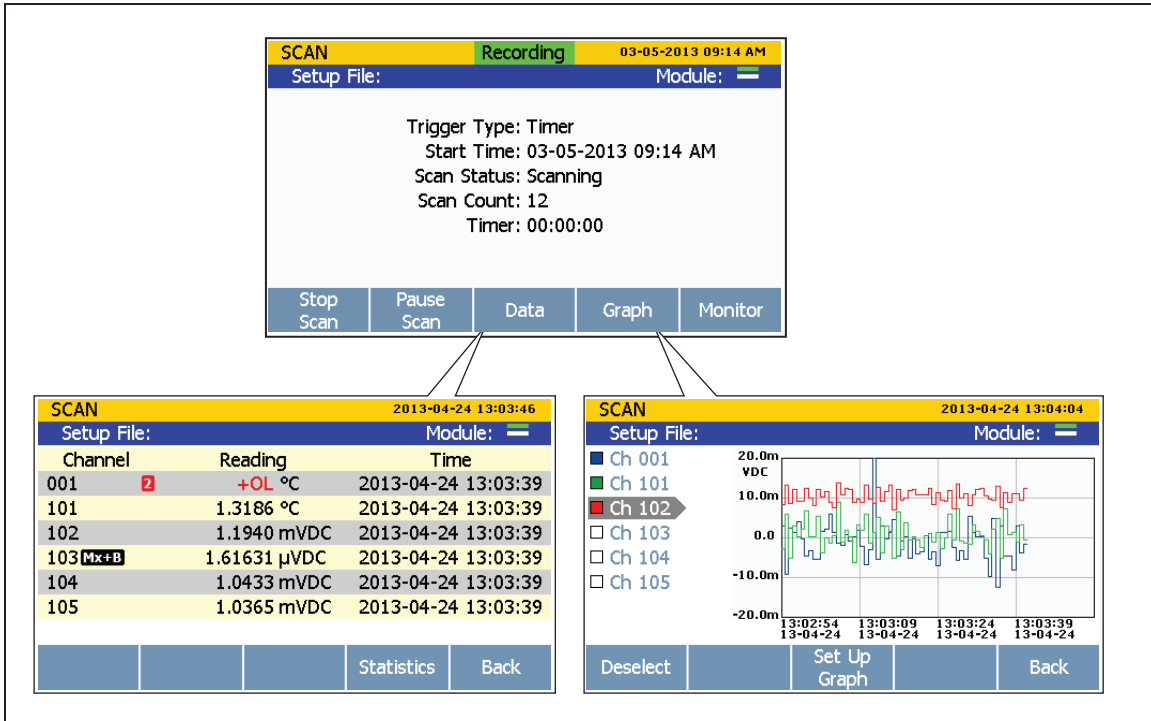

Figure 4-1. Scan Data

hcn045.eps

The Scan menu lets the user control the scan and view the scan data. The Scan menu also shows important status indicators to quickly inform the user of the scan status and progress of the scan. Table 4-1 shows the Scan menu and describes the status indicators and functions that can be performed from this menu. To open the Scan menu, push  on the front panel.

Table 4-1. The Scan Menu



| Item | Function |
|------|---|
| ① | Shows the type of trigger configured in the Test Setup. The trigger type determines when a scan starts and stops. See “Trigger Type” on page 4-7. |

hcn023.eps

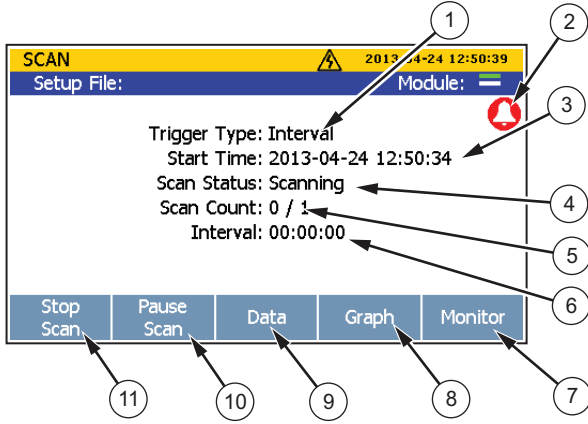
Table 4-1. The Scan Menu (cont.)

| Item | Function |
|------|---|
| ② | Master alarm indicator that displays when any configured channel alarm is tripped while a scan is in progress. To see which alarm tripped, push F3 on the Scan menu to open the channel data. If an alarm has tripped, a [1] or [2] icon will show next to the channel to indicate which alarm is tripped. |
| ③ | Shows then the scan was started. This field is blank until the first scan is started. |
| ④ | Shows the status of the scan. This field shows "Scanning" when a scan is in progress, "Paused" when the scan is paused, "Waiting" when the Instrument is waiting for the trigger, and "Inactive" when scanning is stopped. |
| ⑤ | Shows the number of scan sweeps have been completed since the start of the scan. |
| ⑥ | Countdown timer displayed only when the trigger source is Timer, Alarm or External. |
| ⑦ | Opens the Monitor function to take measurements of a single channel between scan sweeps. See "Monitor" on page 4-15. |
| ⑧ | Opens the Graph feature that lets the user plot the measurement data on a scalable graph. See "Graph the Measurements" on page 4-14. |
| ⑨ | Opens a spreadsheet view of all the most recent samples for each channel along with helpful statistics. See "View Scan Data and Statistics" on page 4-12. |
| ⑩ | Pause a scan after it is started. The softkey is not visible when the scan is inactive. |
| ⑪ | Start or stop a scan. See "Start a Scan" on page 4-11. |

About Scan Timing and Sampling

When a scan is started, the Product sequentially scans and measures (samples) each active channel in ascending channel order. How long it takes to sample a channel depends on the measurement function, the user-programmed channel delay, and the sample rate of the scan. Collectively, the sum of channel sample times determine how long it takes to complete a full scan cycle and is referred to as the sweep time. See Figure 4-2 for an illustration of how the scan process works.

The channel sample times and scan sweep times vary based on the channel and test settings. The items below provide information on how these times can be impacted:

- The minimum channel sample time depends on the sample rate setting and the measurement function.
- The channel sample time includes any necessary settling delay prior to the ADC sample to meet accuracy specifications in usual conditions. Table 4-4 lists the internal fixed settling delays for each parameter type and range.
- In some conditions, it may be necessary to add channel delay to allow for longer settling times. See "Channel Delay" in Chapter 3 for more information.

- The total channel sample time is the minimum sample time plus the user-programmed channel delay. The longer the channel delay, the longer it takes to sample the channel.
- The total scan sweep time is sum of the channel sample times of all the channels scanned. A scan sweep will start when the selected trigger source is asserted if a previous scan sweep is not still in progress (see "Trigger Type" on page 4-7).
- The interval at which scan sweeps occur can be fixed by programming the trigger type to Timer and setting an interval time.

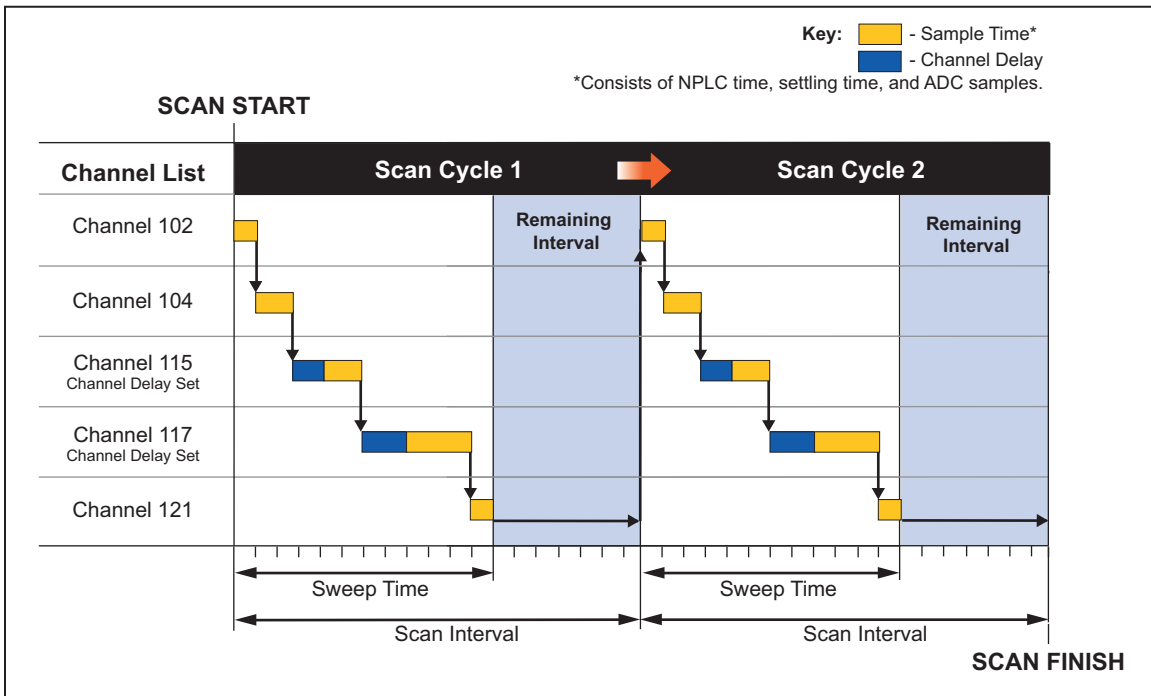

Figure 4-2. Illustration of a Scan Sweep

hcn057.eps

Configure a Scan

Scans are configured in the Test Setup menu that is opened in the Channel Setup menu (push **CHANNEL SETUP** then push **F4**). This section contains information on each parameter in the Test Setup menu to help configure the scan. Figure 4-3 shows the Test Setup menu.

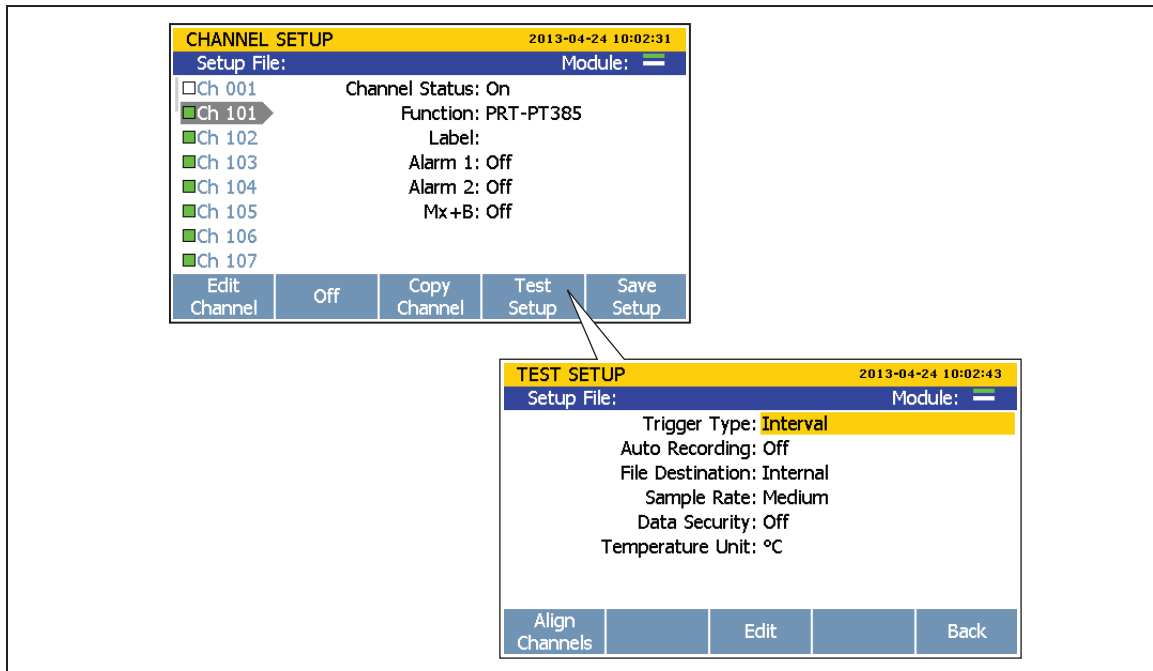

Figure 4-3. Test Setup Menu Example

Trigger Type

The Trigger Type tells the Product when and how to start and stop a scan. There are four trigger types:

Note

If a Scan Count of 0 is set or if the scan interval is shorter than the scan sweep time, the scan continuously repeats until the scan is stopped or the Product runs out of memory.

- The **Interval** trigger type sets the scan to happen on a user-defined numeric interval that is started by a front-panel softkey in the Scan/Monitor menu. The user sets the number of times to scan (Scan Count) and how often the scans occur (Interval).
- The **External** trigger type sets the scan to start when a set TRIG input on the Digital I/O port detects a low condition. Like Interval, the user manually sets the number of times to scan (Scan Count) and the time between the scans (Interval).
- The **Alarm** trigger type sets the scan to start when a HI or LO channel alarm is tripped on a monitored channel. Like Interval, the user manually sets the number of times to scan (Scan Count) and the time between the scans (Interval).
- The **Manual** trigger type sets the scan to happen only when the user manually pushes the Scan/Monitor key on the front panel. This trigger type lets the user set the number of times to scan (Scan Count) when the key is pushed, but does not have an interval time because the interval is a manual key push.
- The **Automated Test** trigger type lets the user define a test sequence to run without the need of user interaction. See “Automated Test” on page 4-16 for more information.

Auto Recording

The Auto Recording feature automates the recording process. If Auto Recording is set to ON, the Product automatically records the scan data to file when the scan is started. If set to OFF, the user must manually push  to start recording.

File Destination

Scan data can be stored to internal memory or a USB drive. If set to Internal, scan data is saved to the internal nonvolatile memory. If set to USB, scan data is saved to the USB drive connected to the front-panel USB port.

Note

Scan data stored directly to the USB drive is not visible to the user through the Memory menu. However, the Memory menu does show the user how much memory is available on the USB drive. To manage the scan data files on the USB drive, connect the USB drive to a PC and open the folder named "Scan". See "Open and View Measurement Data on a PC" on page 4-20.

Sample Rate

The Sample Rate sets the speed the channels are scanned. When set to Fast, the Product scans each channel very quickly that lets the user monitor the channels for rapid measurements changes. As a result of the quicker scan speed, the Product is not given the time to fine tune the measurement and results in a loss of one digit of measurement resolution. For example, a temperature measurement would read 22.41 °C with Slow and 22.4 °C in Fast.

Note

Sample Rate should not be confused with Channel Delay and Rate of Change in the advanced channel options. See "About Scan Timing and Sampling" for more information.

The three Sample Rates are: Fast, Medium, and Slow. Table 4-2 shows the sample speeds for the different input types and ranges.

Table 4-2. Scan Sample Rates

| Functions | Range or CJC Type | Sample Time (s) | | |
|---|-----------------------|---------------------|--------|------|
| | | Fast | Medium | Slow |
| PRT | 400 Ω Range | 0.08 | 1.00 | 4.00 |
| | 4 k Ω Range | 0.20 | 1.00 | 4.00 |
| Thermistor | 2.2 k, 90k Ω Range | 1.00 | 1.00 | 4.00 |
| | 1 M Ω Range | 1.00 | 1.00 | 4.00 |
| T/C | Internal CJC | 0.08 ^[1] | 1.00 | 4.00 |
| | External CJC | 0.08 ^[2] | 1.00 | 4.00 |
| | Fixed CJC | 0.08 ^[2] | 1.00 | 4.00 |
| V dc | 100 mV, 1 V, and 10 V | 0.08 | 1.00 | 4.00 |
| | 50 V | 0.20 | 1.00 | 4.00 |
| mA dc | All Ranges | 0.10 | 1.00 | 4.00 |
| Resistance | 100, 1k Ω Ranges | 0.10 | 1.00 | 4.00 |
| | 10k, 100k Ω ranges | 0.20 | 1.00 | 4.00 |
| | 1M Ω Range | 1.00 | 1.00 | 4.00 |
| | 10M, 100M Ω Ranges | 1.00 | 2.00 | 4.00 |
| Note [1] - For Fast, the sample time of CJC (0.05 s) is excluded, while the sample time of CJC is included for Medium and Slow. [2] - Add 0.02 s if open detect is enabled. | | | | |

Data Security

Data security is used to secure data files that are traceable back to the user that performed the test (commonly referred to as test traceability). This is necessary for test environments and applications that require a method to guarantee that the test data has not been forged, changed, or tampered with, and was produced by trained, authorized personnel.

If the data security setting in the Test Setup menu is set to ON, the user must select a user profile and enter the associated password in order to start and record a scan. The user information is recorded into the scan data file that contains the user profile number and test information. For more information on the scan data files, see “Record” on page 4-16. For instructions on how to change the Admin or User profile passwords, see “Change the Admin and User Passwords” in Chapter 2.

When Data Security is on, Setup files are also protected. A setup file created with Data Security on cannot be changed or deleted except by an authorized user.

Note

If the guest option is used to start a scan, the user is recorded as "Guest" and the data file is not considered authorized and traceable.

Temperature Unit

This is an overall Product setting that sets the temperature units to be shown in either Celsius or Fahrenheit.

Notes











- *The ability to change this setting to Fahrenheit is not available in some regions.*
- *Mx+B and Alarm settings of temperature channels are reset when the temperature unit is changed.*

Align Channels

The Align Channels function lets the user designate a reference channel to align other channels to so that measured offsets between sensors can be set to zero relative to one another and the reference channel. This is accomplished with an Mx+B offset that is automatically applied to the selected channels to make them match the reference channel.

An application where this is commonly used is for temperature measurements. For example, a reference probe that is fully calibrated is put into a chamber with other probes that reads 250.52 °C. With the align function, the user sets the calibrated reference probe channel to be the reference channel. The user then sets four probes channels to be aligned with that reference that currently read 250.52 °C, 250.68 °C, 250.71 °C, 250.33 °C. When the user aligns the probes, the Product calculates and applies an Mx+B offset to the probes so that the displayed measurement value is the same as the reference probe. The result is that all four probes now measure 250.52 °C.

To align to a reference channel:

1. Push .
2. Push .
3. Push .
4. Use  and  to select a channel as the reference then push .
5. Use  and  to highlight a channel then push  to select or deselect. Multiple channels can be selected to align.
6. Push  to align the channels. The Product will take measurements on the reference channel and selected channels, then use Mx+B function to align these channels to the reference.

Automatic Power Loss Scan Resume

In the event that the Product experiences a loss of mains power while a scan is in progress, it can be configured to resume the scan when mains power comes on. This feature is referred to as “Power Loss Resume State”.

Note

This setting is located in the Instrument Setup menu and not the Test Setup menu.

Unlike when a new scan is started, the Product will resume recording to the file that it was recording to when the mains power was lost.

To turn on this feature:

1. Push .
2. Push  or  to highlight **Resume Scan** then .
3. Set to **ON** then push .







Basic Scan Procedures









Start a Scan

To start a scan:



Note

Once a scan is started, the scan must be paused or stopped before the Channel Setup or the Instrument Setup menu can be accessed.

1. Configure the Test Setup. See “Configure a Scan” on page 4-6.
2. Set all channels to be scanned to **ON**. See “Set Channels to ON of OFF” in Chapter 3.
3. Push .
4. Start the scan as follows:
 - For the **Interval** trigger type: Push  to start the scan. The scan completes the amount of scan cycles set then automatically stops. At any time, push  again to stop the test or push  to pause the test. If automatic recording is set to OFF, push  to record data.
 - For the **External** trigger type: Push  to start the scan. The scan is triggered by a low condition in the rear-panel Trig input. Once the low condition is detected, the scan sweep starts and runs as directed by the interval configuration. When the low condition that triggered the scan is removed, the Product will finish the scan in progress then stop and wait for next external trigger.

- For the **Alarm** trigger type: The scan sweep is triggered by an alarm that has tripped. To do this, select the Alarm trigger type in the test setup and assign a channel to be a trigger. When the scan is started, the Product automatically starts to monitor the channel set as the trigger for a tripped alarm. Once an alarm is tripped, the scan sweep starts and runs as directed by the test setup. Scan sweeps will continue as long as the alarm is tripped. If the alarm is no longer tripped, the Product will finish the scan in progress then wait for next alarm trip.
 - a. Configure the applicable channel alarm as previously described.
 - b. Push  then push  to start the scan.
- For the **Manual** trigger type: Push  to start the scan. The scan performs one scan cycle then stops. Push  again to trigger another scan cycle. At any time, push  again to stop the test or push  to pause the test. If automatic recording is set to OFF, push  to record data.
- For the **Automated Test** trigger type: Push  then push  to start the test. The Product reads the setpoint information and automatically starts a scan sweep when the setpoint parameters (Setpoint, Tolerance, Stability, and Soaktime) are met. If the Control Source parameter is set to On and the Product is connected to an external temperature source, the Product sets the temperature without the need for the user to do so. The scan repeats for the amount of times set in the Scan Count setting at each setpoint.

View Scan Data and Statistics

The Scan Data feature lets the user see the scan data from the last scan sweep (see Figure 4-4). This feature is located in the Scan menu (push  then push ). The data on this menu updates in real-time. From the Scan Data menu, the user can open a Statistics menu to view minimum, maximum, average, and standard deviation statistics for each channel (see Table 4-3).

If Mx+B is applied to the channel, an [Mx+B] icon will show next to the channel number. If an alarm is tripped, the alarm number will show next to the channel as a red icon and also the measurement value will be red. See Figure 4-4.

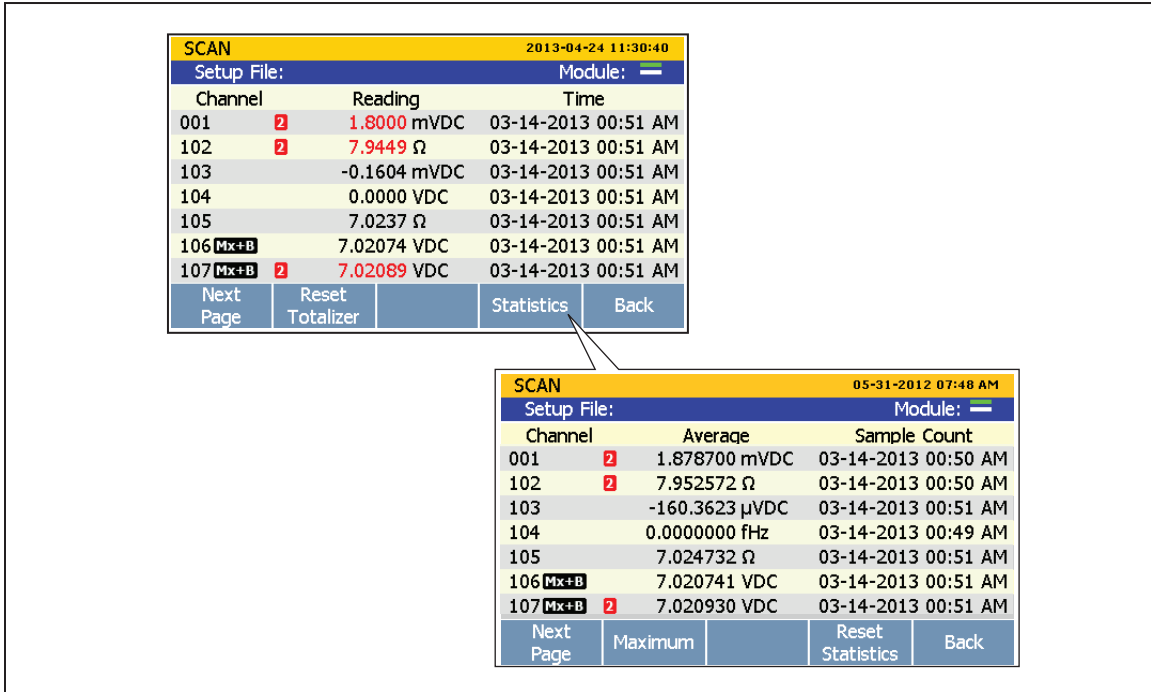

Figure 4-4. Scan Data

hcn061.eps

Table 4-3. Scan Statistics

| Statistic | Description |
|--------------------|---|
| Maximum | Maximum measurement. |
| Minimum | Minimum measurement. |
| Average | Average of all the measurements taken. |
| Standard Deviation | A measure of the distribution of a set of data from its mean. The more spread apart the data, the higher the deviation. |
| Peak-to-Peak | Difference between the Maximum and the Minimum. |
| Rate of Change | A measure of how much the readings change over time. |

To view the scan data:

1. Start a scan. See “Start a Scan” on page 4-11.
2. Push **F3** to open the Scan Data menu. After the menu opens, push **F1** to cycle the menu pages to view more channels.
3. To view channel statistics, push **F4**.
4. To cycle through the available statistical values, push **F2**.

Graph the Measurements

The Scan function has a graph feature that lets the user display the measurement data in a graph. This feature is located in the Scan menu (push **SCAN MONITOR** then push **F4**). The graph automatically scales to fit all the information on the display when opened. To refine the data, the graph can be manipulated with the front-panel arrow keys as shown in Figure 4-5.

Notes

The maximum number of channels that can be graphed at once is four.

Selection of two or more channels with different input types (such as temperature and milliamps) can make the graph difficult to read because they do not share the same unit. To prevent this, only select channels of the same input type or view the channels one at a time.

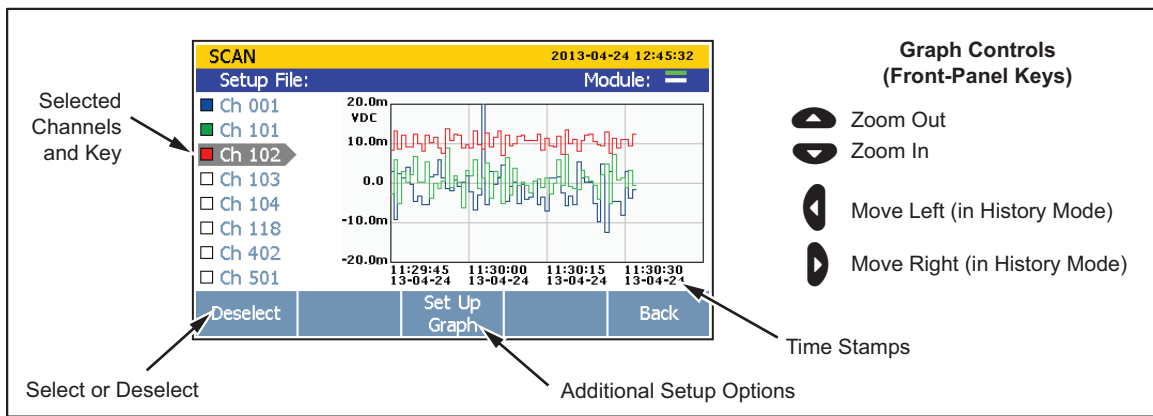

Figure 4-5. Graph Feature

hcn062.eps

To see the measurement data in a graph:

1. Push **SCAN MONITOR**.
2. Push **F4** to show the graph. To show a channel on the graph, use **▲** and **▼** to select a channel, then push **F1** to select or deselect. To view additional graph options, push **F3**.

Monitor

Monitor lets the user measure a single channel between scan sweeps. In addition, the user can view statistics and a graph of the measurement data since the scan began. To monitor a channel, push **F5** on the Scan menu. When a scan is in progress, the display shows the measurement from the last reading. If a scan is not in progress, the display shows a real-time measurement.

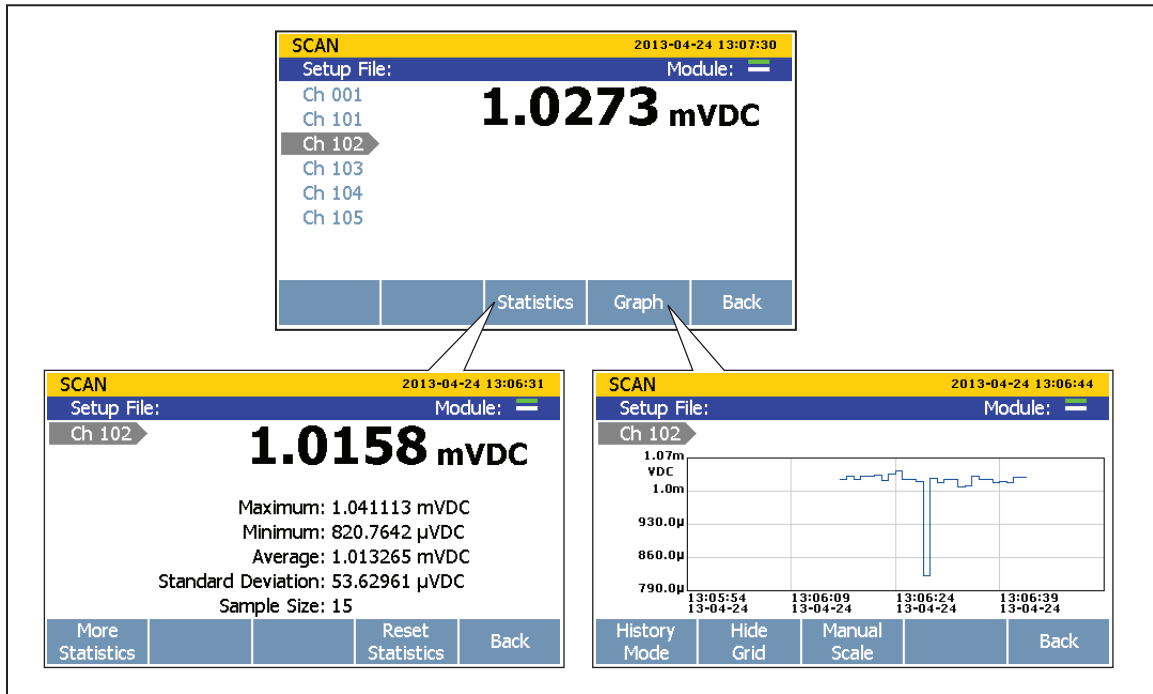

Figure 4-6. Monitor Menu

hcn053.eps

To monitor a channel:

1. Set all channels to be scanned to ON. See “Set Channels to ON or OFF” in Chapter 3.
2. Push **SCAN MONITOR**.
3. Push **F5** to open the Monitor menu. The first active channel is displayed.
4. Push **▼** or **▲** to switch between channels.

Automated Test

Overview

The Product has an automated test feature that works directly with an external temperature source (the source) to calibrate and verify the performance of temperature probes (UUT) against a calibrated reference probe.

To fully automate the test, the user can connect to and control a temperature source such as dry-wells, microbaths, or fluid baths from Fluke Calibration. In this configuration, the Product communicates the setpoint to the source via the RS-232 connection on the rear panel (see Figure 4-7). The source is then activated and sets the temperature to the setpoint. When the measurement from the reference temperature probe that is wired to the Product meets all the parameters of the setpoint (tolerance, stability, and soak time), the Product automatically communicates the next setpoint. This sequence repeats until all setpoints are complete.

Note

The Automated Test has a Control Source setting that can be toggled to On or Off. When Off, the operator must manually set the temperature on the source.

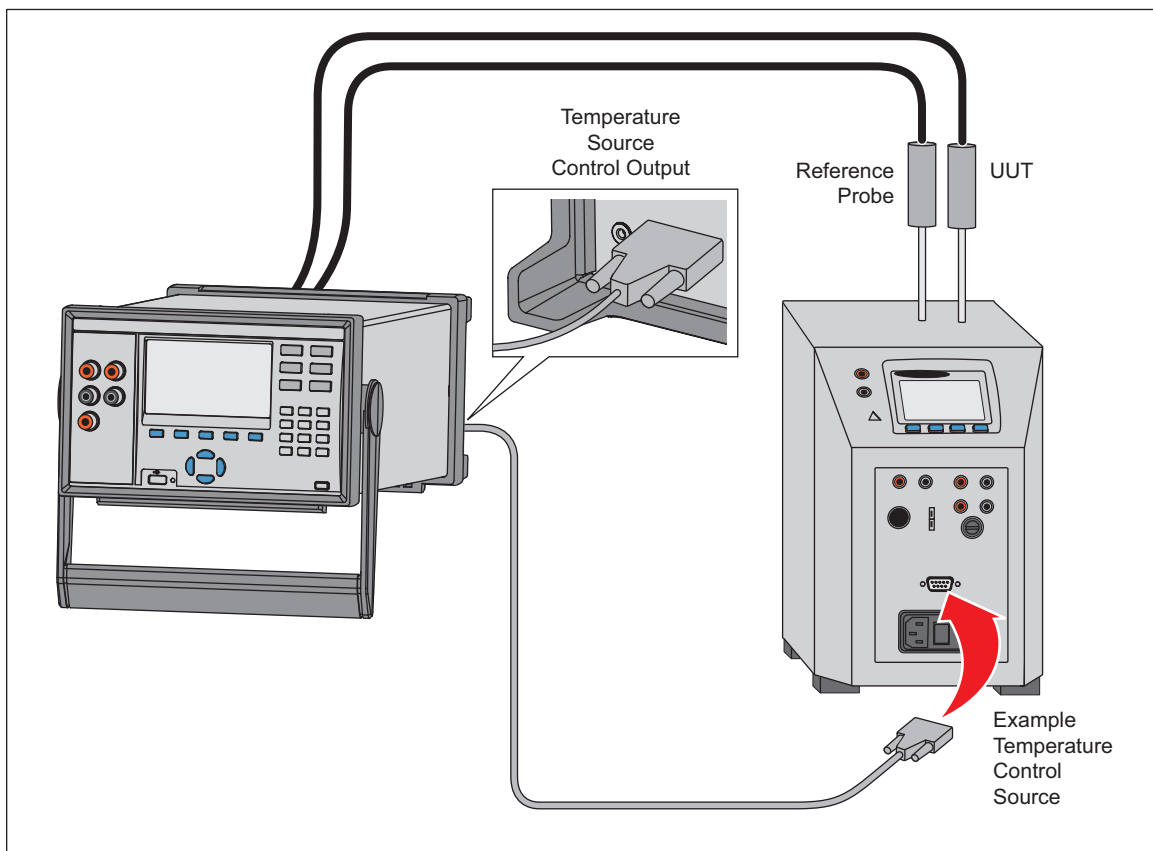
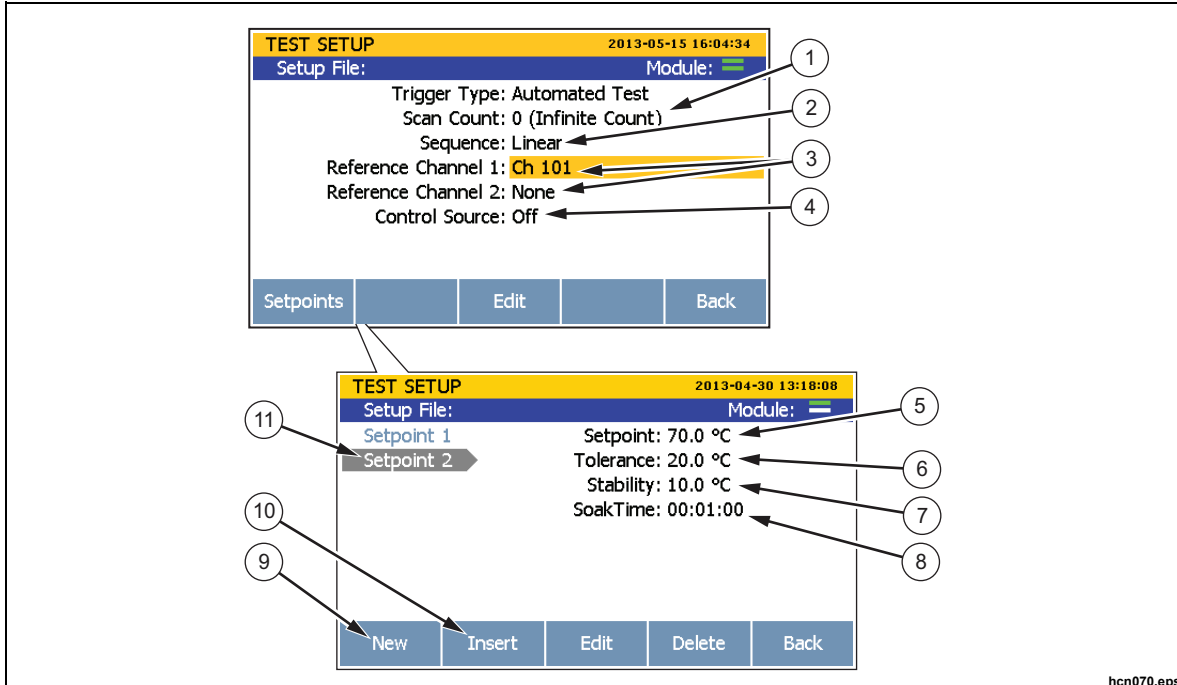

Figure 4-7. External Temperature Control Source

Configure an Automated Test

The Automated Test is a trigger type that is configured in the Test Setup menu. The options in the Automated Test setup lets the user set a series of custom temperature setpoints and select a test sequence that the Product will run without user interaction. Refer to Table 4-4 to setup an Automated Test.

Table 4-4. Automated Test Setup









| Item | Function |
|------|---|
| ① | Sets the number of times to repeat a scan sweep at each setpoint. |
| ② | <p>Sets the test sequence. Selections available:</p> <p>Linear – This scan sequence will scan the first reference channel (Ref1), then all of the enabled channels in ascending channel order, followed by the optional second reference channel (Ref2). For example: <i>Ref1 > Ch102 > Ch103 > Ch104 > Ref2</i>.</p> <p>Alternate Reference – This scan sequence will scan the first reference channel (Ref1), then a single channel, followed by the optional second reference channel (Ref2). This then repeats for all the other enabled channels. For example: <i>Ref1 > Ch102 > Ref2 > Ref1 > Ch103 > Ref2 > Ref1 > Ch104 > Ref2</i>.</p> <p>Up/Down – This scan sequence will scan the first reference channel (Ref1), then all of the enabled channels in ascending channel order, followed by the optional second reference channel (Ref2). This is then immediately repeated in reverse, descending order. For example: <i>Ref1 > Ch102 > Ch103 > Ch104 > Ref2 > Ref2 > Ch104 > Ch103 > Ch102 > Ref1</i>.</p> |
| ③ | Set the reference channels that the reference probes are connected to. The Reference Channel 1 is required, the Reference Channel 2 is optional. |

Table 4-4. Automated Test Setup (cont.)

| Item | Function |
|------|---|
| ④ | Turn on or turn off the control source on the rear-panel that connects to an external temperature source. |
| ⑤ | Set the target temperature (referred to as the setpoint). |
| ⑥ | Set the tolerance band around the setpoint. For example, if a 3 °C tolerance was set for a 20 °C setpoint, the tolerance band would be 20 °C ±3 °C. The reference probe temperature must be within this range for a scan to proceed. |
| ⑦ | Set the temperature stability setpoint. Stability is achieved when the temperature is within the stability band for the Soaktime duration. For example: A setpoint of 100 °C is configured with these parameters: Stability 0.05 °C, Soaktime 10 minutes. The Product will start the scan sweep when the tolerance is within range (see item ⑥) and the peak-to-peak value of the measurement is less than 0.05 °C for 10 minutes (because of the 0.05 °C Stability and the 10 minute Soaktime). |
| ⑧ | Sets the duration (in minutes) that each of the programmed SETPOINTS temperature is maintained before scanning starts. The time starts when the temperature settles to within the specified stability. |
| ⑨ | Make a new setpoint. |
| ⑩ | Insert a new setpoint in a certain position in the list of setpoints. The new setpoint is inserted above the selected setpoint. |
| ⑪ | List of setpoints. |

Connect to An External Source

Connect to an external source (the source) as follows:

1. Connect the accessory RS-232 cable to the rear-panel Temperature Source output on the Product. Connect the other end of the cable to the source. The cable must be a crossed (null modem) type.
2. Push . Use the  arrow to select Temperature Source then push .
3. Use the  or  arrows to select the baud rate of the source then push .

Note

Refer to the User Documentation of the source to find the baud rate.

Record

The Record function saves the scan or DMM measurement results to a file that can be transferred to a PC for further evaluation. When the Product is recording data, the Record key is illuminated and “RECORDING” shows on the top of the display. Data is recorded for as long as the key is illuminated and “RECORDING” shows on the display.

Note

Scans can be completed without recording the results. In this scenario, the data is saved to temporary memory and will be overwritten the next time a scan is started or if the temporary memory becomes full (approximately 60,000 readings).

Record Measurement Data

For the Scan function, the behavior of the Record key is dependent on the Auto Recording setting in the Test Setup menu. If set to ON, the Product automatically records the scan data when the scan is started. If set to OFF, the user must manually push  to record scan data to file after the scan is started.

Note

Auto Recording is associated only with the Scan/Monitor function and does not work with the Measure/DMM function. To record a measurement, push  to start recording DMM or Measure data regardless of the Auto Recording setting in the Test Setup menu.

Each time data is recorded, a new data folder is made with a unique timestamp so that it can be easily found and managed (see “Open a Data File on a PC”). Data files made from a scan are saved in the “scan” folder, DMM data files are saved in the “dmm” folder and, Measure data files are saved in the “meas” folder.

Note

Scan data, Measure data, or DMM data stored directly to the USB drive is not visible to the user through the Memory menu. However, the Memory menu shows the user how much memory is available on the USB drive. To manage the scan data files on the USB drive, connect the USB drive to a PC and open the folder named “scan”, “meas”, or “dmm”.

Memory Consumption for Recorded Data

The amount of memory consumed by recorded scan data varies based on how many channels are recorded and the number of scan cycles completed. See the information in Table 4-5 to estimate memory consumption. For front-panel DMM recording, it takes approximately 400 hours to consume 1 GB of memory.

Table 4-5. Scan Data Memory Usage

| Channels Recorded | Bytes Used Per Scan | Approximate Scans Cycles to Reach 1 GB |
|-------------------|---------------------|--|
| 20 Channels | 320 bytes | 3,125,000 scans cycles |
| 40 Channels | 600 bytes | 1,666,000 scans cycles |
| 60 Channels | 880 bytes | 1,136,000 scan cycles |

Open and View Measurement Data on a PC

After a recorded scan is finished, the data file can be transferred to a PC where the results can be viewed in Microsoft Excel. To open the a data file on a PC:

1. Put the data on the USB drive to be transferred to the PC. If the Data file is on the internal memory, copy the file to the USB drive. If the scan was set up to record directly to the USB, the data file is already on the USB drive and no action is necessary.
2. Remove the USB drive from the front panel and insert it into a USB port on the PC.
3. Open the Start menu and search for the word “Computer” to open the Computer Drive manager (see image below).



4. Find the USB drive and double-click on it to explore the contents.
5. Navigate to the data folder as follows (see Figure 4-9 for an example of the folder structure):
 - a. Double-click on the **fluke** folder.
 - b. Double-click on the **1586A** folder.
 - c. Double-click on the serial number of the Product used to record the data. In the example, **12345678** is the serial number of the Product.

- d. Double-click on the **data** folder.
- e. Double-click on the **scan** folder to see scan data files or the **DMM** folder to see DMM data files. The data files are saved within a folder that was named with a timestamp of when the scan or measurement was recorded. This file naming convention is illustrated in Figure 4-8.

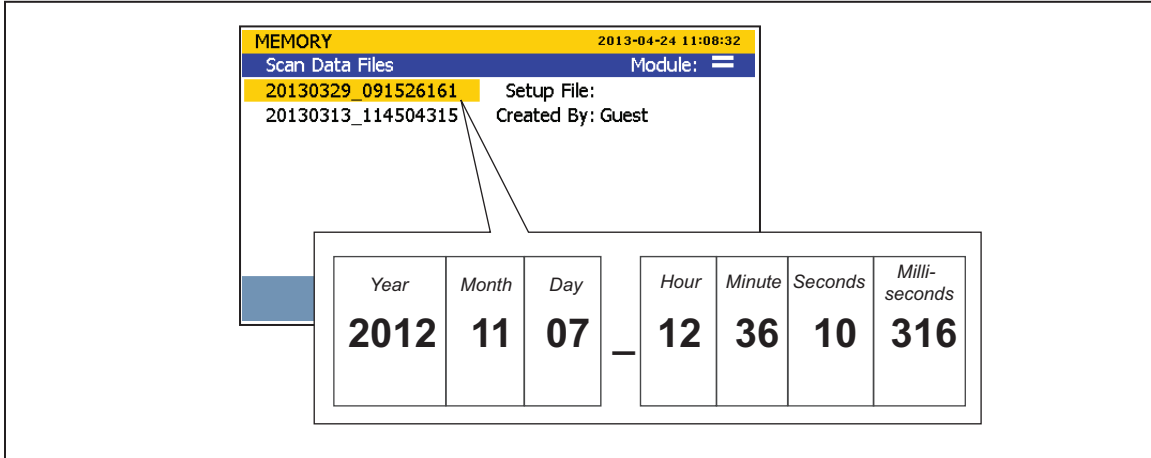

Figure 4-8. Scan Data File Name Convention

hcn047.eps

- 6. Choose a file to open then double-click on the file. The time-stamped data folder contains two comma-separated values (.csv) files: **setup.csv** and **dat00001.csv**. The setup.csv file contains all the test parameters that were configured when the data was recorded. The dat00001.csv contains all of the recorded measurement data. See Figure 4-9.

Note

The Product will make a new data file when the number of lines exceed 65535. For example, Dat00002.csv will be made when Dat00001.csv is filled.

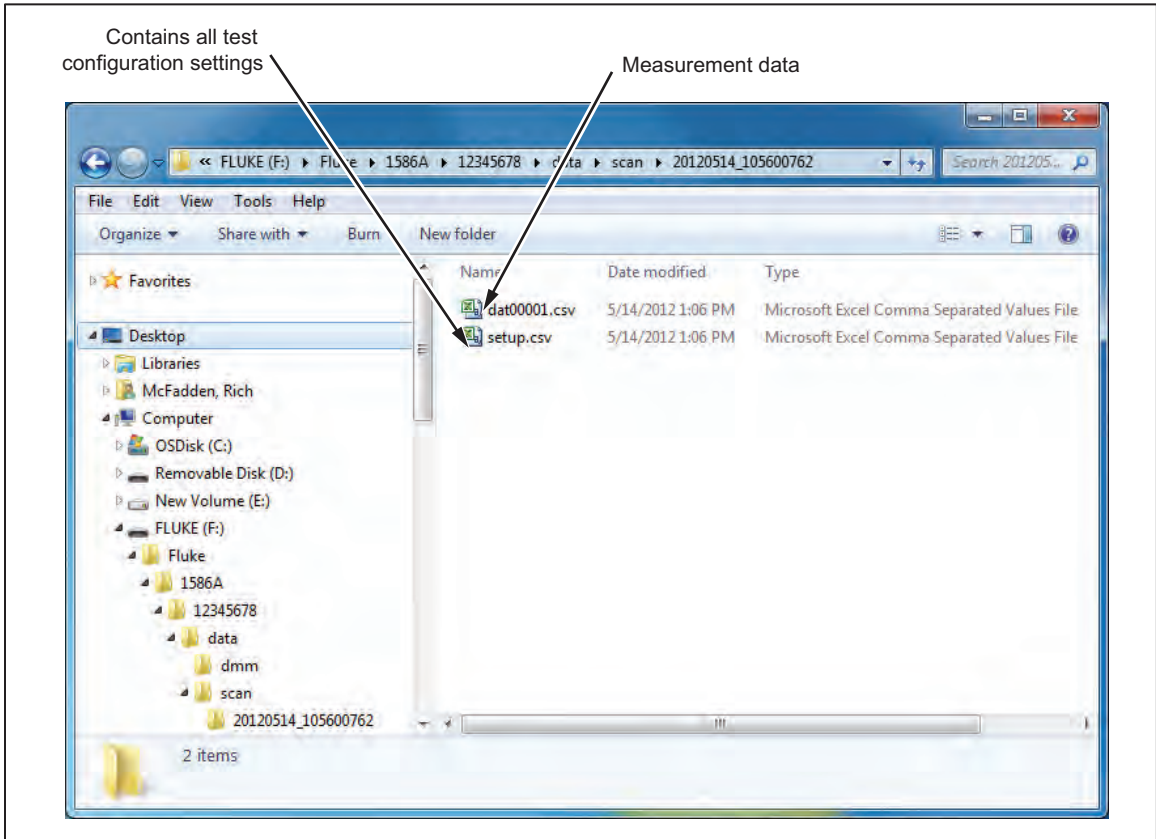

Figure 4-9. Setup.csv and Dat00001.csv Files

hcn064.eps

How to Read the Setup CSV File

The six sections of the setup.csv spreadsheet are discussed and shown in the subsequent sections.

General Information

This section of the spreadsheet shown below contains general information on the scan performed such as the start time and the Operator.

| | |
|------------|----------------|
| Test Setup | |
| Start Time | 4/4/2012 10:03 |
| User | GUEST |

Instrument Information

This section of the spreadsheet shown below contains general information on the Product such as the serial number and last calibration date. This section also shows the Input Module configuration used.

| Instrument | Hardware | Model | Serial Nur | Version | CAL Date |
|------------|----------|-------|------------|---------------|-----------|
| Mainfram | 1586A | | 12345678 | 20130504+0.33 | 3/26/2013 |
| Slot1 | 2586A | | 23456789 | (n/a) | 1/31/2013 |
| Slot2 | NONE | | (n/a) | (n/a) | (n/a) |

Analog Channels

This section of the spreadsheet shown below contains configuration information on each analog channel that was recorded.

| Analog Channels | | | | | | | | | |
|-----------------|---------|-----------|---------------|-------------|-------|------|----------|-----------|-------|
| Channel | Label | Function | Channel Delay | Rate of Cha | Range | NPLC | Band Wid | Input Imp | Open |
| Ch001 | FP | VOLT | | 0 MIN | | 3 | 10 (n/a) | 10M | (n/a) |
| Ch101 | | VOLT | | 0 MIN | | 2 | 10 (n/a) | 10M | (n/a) |
| Ch102 | | TEMP TC | | 0 MIN | AUTO | | 10 (n/a) | (n/a) | ON |
| Ch103 | | TEMP TC | | 0 MIN | AUTO | | 10 (n/a) | (n/a) | ON |
| Ch104 | PROBE_F | TEMP TC | | 0 SEC | AUTO | | 10 (n/a) | (n/a) | ON |
| Ch105 | | TEMP TC | | 0 MIN | AUTO | | 10 (n/a) | (n/a) | ON |
| Ch106 | | TEMP RTD | | 0 MIN | AUTO | | 10 (n/a) | (n/a) | (n/a) |
| Ch107 | | TEMP TC | | 0 MIN | AUTO | | 10 (n/a) | (n/a) | ON |
| Ch108 | S | VOLT | | 0 MIN | | 1 | 10 (n/a) | 10M | (n/a) |
| Ch109 | | TEMP THER | | 0 MIN | AUTO | | 10 (n/a) | (n/a) | (n/a) |
| Ch110 | | TEMP RTD | | 0 MIN | AUTO | | 10 (n/a) | (n/a) | (n/a) |
| Ch112 | S | VOLT | | 0 MIN | | 1 | 10 (n/a) | 10M | (n/a) |
| Ch113 | S | VOLT | | 0 MIN | | 1 | 10 (n/a) | 10M | (n/a) |
| Ch114 | S | VOLT | | 0 MIN | | 1 | 10 (n/a) | 10M | (n/a) |
| Ch115 | S | VOLT | | 0 MIN | | 1 | 10 (n/a) | 10M | (n/a) |
| Ch117 | S | VOLT | | 0 MIN | | 1 | 10 (n/a) | 10M | (n/a) |
| Ch118 | S | VOLT | | 0 MIN | | 1 | 10 (n/a) | 10M | (n/a) |
| Ch119 | S | VOLT | | 0 MIN | | 1 | 10 (n/a) | 10M | (n/a) |
| Ch121 | | CURR | | 0 MIN | AUTO | | 10 (n/a) | (n/a) | (n/a) |
| Ch122 | | CURR | | 0 MIN | AUTO | | 10 (n/a) | (n/a) | (n/a) |

Digital Channels

This section of the spreadsheet shown below contains configuration information for the DIO channel and the TOT channel.

| Digital Channels | | | | | |
|------------------|-------|----------|------------|-----------|--------------|
| Channel | Label | Function | DIO Output | TOT Mode | TOT Debounce |
| Ch401 | | DIO | | 255 (n/a) | (n/a) |
| Ch402 | | TOT | (n/a) | READ | Off |

Math Channels

This section of the spreadsheet shown below contains configuration information for the math channels.

| Math Channels | | | | | | | | | | | | |
|---------------|-------|----------|------|-------------|-------|-------|-------|-------|-------|-------|-------|-------------|
| Channel | Label | Function | Type | Rate of Cha | C0 | C1 | C2 | C3 | C4 | C5 | C6 | Channels |
| Ch501 | | MATH | ADD | MIN | (n/a) | (n/a) | (n/a) | (n/a) | (n/a) | (n/a) | (n/a) | Ch101 Ch103 |
| Ch502 | SQRT | MATH | SRO | MIN | (n/a) | (n/a) | (n/a) | (n/a) | (n/a) | (n/a) | (n/a) | Ch101 |

Test Setup Parameters

This section of the spreadsheet shown below contains the test setup settings that were used to run the scan.

| Test Setup | | | | | | | | | | | |
|------------|--------------|-------------|------------------|------------|----------|-----------|----------|-----------|----------|-------|---------------|
| Setup Nam | Trigger Type | Auto Record | File Destination | Sample Rat | Security | Scan Cour | Interval | TriggerCh | Sample C | Ref1 | Num Of Points |
| | TIM | ON | USB | NPLC | OFF | 100 | | 0 (n/a) | (n/a) | (n/a) | (n/a) |

How to Read the Data CSV File

The dat00001.csv file contains the measurement data from the scan. Each row contains measurement data for a single scan sweep and shows the time when the sweep completed. To see how the test and channels were configured, view the information in the setup.csv file (see “How to Read the Setup.csv File”).

All measurements can easily be toggled to engineering notation with the cell formatting options within Microsoft Excel. An example of the spreadsheet is shown below.

| Record # | Time | Ch 001 (V) | Ch 101 (V) | Ch 102 (C) | Ch 103 (C) | Ch 104 (C) | Ch 105 (C) | Ch 106 (C) | Ch 107 (C) | Ch 108 (V) |
|----------|---------|------------|------------|------------|------------|------------|------------|------------|------------|------------|
| 1 | 04:10.2 | 9.82E-04 | -1.95E-06 | 25.23118 | 25.31694 | 26.96164 | 24.89176 | 9.90E+37 | 9.90E+37 | 9.89E-04 |
| 2 | 04:19.6 | 9.84E-04 | -1.35E-05 | 24.96417 | 25.32083 | 26.79717 | 24.89303 | 9.90E+37 | 9.90E+37 | 9.76E-04 |
| 3 | 04:29.0 | 9.75E-04 | -1.66E-05 | 24.93361 | 25.32176 | 26.89517 | 24.87964 | 9.90E+37 | 9.90E+37 | 1.02E-03 |
| 4 | 04:38.3 | 9.87E-04 | -1.38E-05 | 25.02723 | 25.3208 | 26.98641 | 24.88509 | 9.90E+37 | 9.90E+37 | 1.04E-03 |
| 5 | 04:47.7 | 9.49E-04 | -5.63E-06 | 25.18236 | 25.3241 | 26.81155 | 24.86407 | 9.90E+37 | 9.90E+37 | 1.04E-03 |
| 6 | 04:57.1 | 1.02E-03 | -3.90E-06 | 25.25767 | 25.33134 | 26.5986 | 24.86986 | 9.90E+37 | 9.90E+37 | 1.10E-03 |
| 7 | 05:06.5 | 1.01E-03 | -4.42E-06 | 25.03256 | 25.32218 | 26.38639 | 24.86133 | 9.90E+37 | 9.90E+37 | 1.05E-03 |
| 8 | 05:15.9 | 9.75E-04 | -1.05E-05 | 24.82163 | 25.29039 | 26.34924 | 24.84834 | 9.90E+37 | 9.90E+37 | 1.05E-03 |
| 9 | 05:25.2 | 9.93E-04 | -1.54E-05 | 24.72215 | 25.2746 | 26.40215 | 24.83991 | 9.90E+37 | 9.90E+37 | 1.06E-03 |
| 10 | 05:34.6 | 9.92E-04 | -1.32E-05 | 24.82524 | 25.27247 | 26.5988 | 24.85923 | 9.90E+37 | 9.90E+37 | 1.07E-03 |
| 11 | 05:44.0 | 9.90E-04 | -1.33E-05 | 24.92385 | 25.27348 | 26.78825 | 24.85618 | 9.90E+37 | 9.90E+37 | 1.08E-03 |
| 12 | 05:53.4 | 9.87E-04 | -9.18E-06 | 25.04537 | 25.25016 | 26.86346 | 24.87239 | 9.90E+37 | 9.90E+37 | 1.04E-03 |
| 13 | 06:03.2 | 9.69E-04 | -1.23E-05 | 24.8901 | 25.22368 | 26.66354 | 24.87937 | -9.90E+37 | 9.90E+37 | 1.01E-03 |

Chapter 5

Measure/DMM Operation

| Title | Page |
|---|------|
| Introduction..... | 5-3 |
| About the Measure Function..... | 5-3 |
| About the DMM Function | 5-3 |
| Input Type Selection and Range Adjustment | 5-4 |
| Relative Measurements..... | 5-4 |
| Graph the Measurements | 5-5 |
| Measurement Statistics | 5-6 |

Introduction

This chapter supplies instructions on how to operate the Measure/DMM function of the Product.

About the Measure Function

The Measure function lets the user quickly measure a single channel. To use this function, push **MEASURE/DMM** on the front panel. The Measure function operates similarly to the Monitor function and has the same graphing and statistic features. For information on how to use this function, refer to the instructions in the Monitor section in Chapter 4.

To use the Measure function, channels must first be configured in Channel Setup (see Chapter 3). Any channel configured and turned on in Channel Setup can be quickly selected for measurement in Measure mode. The selected channel is then measured continuously. Trigger sources are ignored.

About the DMM Function

The DMM is a digital multimeter feature lets users quickly connect test leads to the front-panel to make voltage, resistance, current, and temperature measurements. It is not necessary to configure the front channel in Channel Setup to use the DMM function. To use this function, push **MEASURE/DMM** then **F5**. To return to the Measure function, push **F5** to show the Options menu, then push **F4**. As these measurements are taken, these measurements values are shown on the screen and can also be recorded to file. These recorded files are referred to as DMM Data files.

Note

The DMM function is an individual function of the Product that does not read or share configuration information with channel 001 in the channel list. For example, use of the DMM feature does not automatically configure and set channel 001 to ON in the Channel Setup menu.

Figure 5-1 shows an example of a front-panel input configuration.

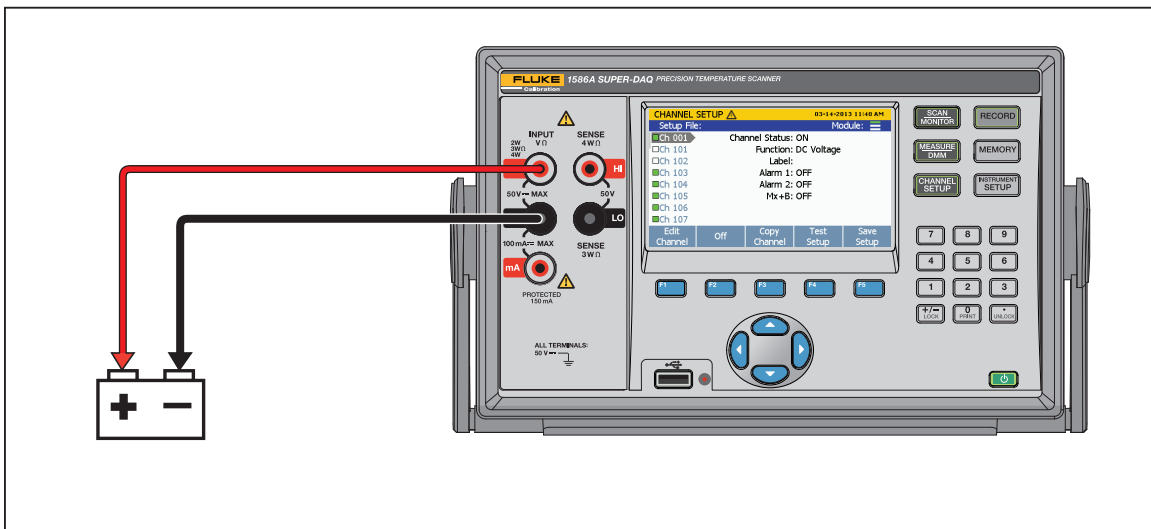

Figure 5-1. Example Voltage Front-Panel Connection

hcn013.eps

Input Type Selection and Range Adjustment

The DMM menu has four softkeys available to select and configure the front-panel inputs for the measurement type. After a softkey is pushed, the user is prompted for additional input information to fully configure the input. To adjust the range of the measurement after the input is configured, push the \blacktriangleleft and \blacktriangleright keys on the front panel to cycle through the available range selections. Push the \blacklozenge and \blacklozenge to adjust the rate setting, which determines the sample rate.

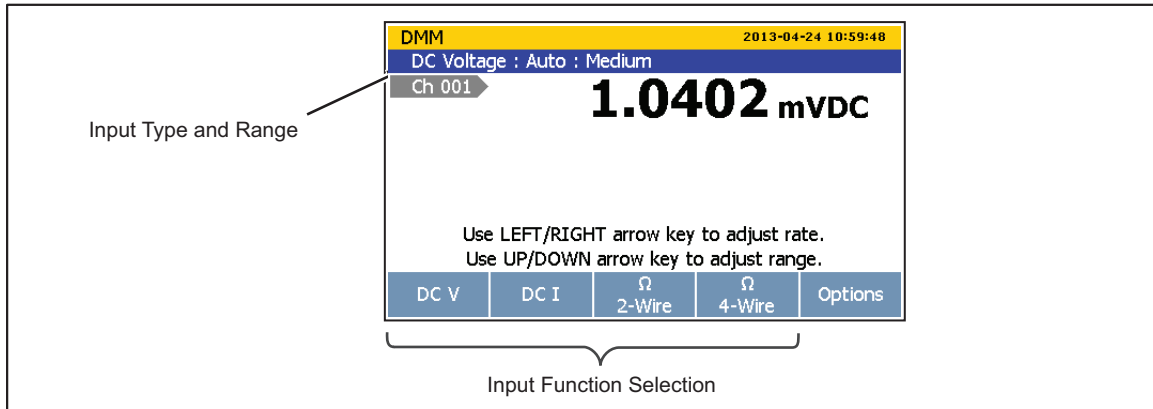

Figure 5-2. Input Function Selection

hcn043.eps

Relative Measurements

The DMM feature has a relative function that lets the user make relative measurements. A relative measurement is the difference above or below a baseline measurement value.

To make a relative measurement, a measurement is made from the front panel then the REL softkey is pushed (**F1**). The Product takes the measurement and freezes it as the baseline measurement as shown in Figure 5-3. Any measurements made after this point is shown as the amount above or below the baseline measurement that is referred to as the relative measurement value. When REL function is activated, the range is locked automatically.

To make a relative measurement:

1. Push **MEASURE DMM**.
2. Push **F5** to open the DMM Menu.
3. Configure the input.
4. Push **F5** to show the channel options.
5. Make a measurement from the front panel. After the measurement is stable, push **F1** (REL) to set the baseline.
6. Observe subsequent readings as relative measurements.

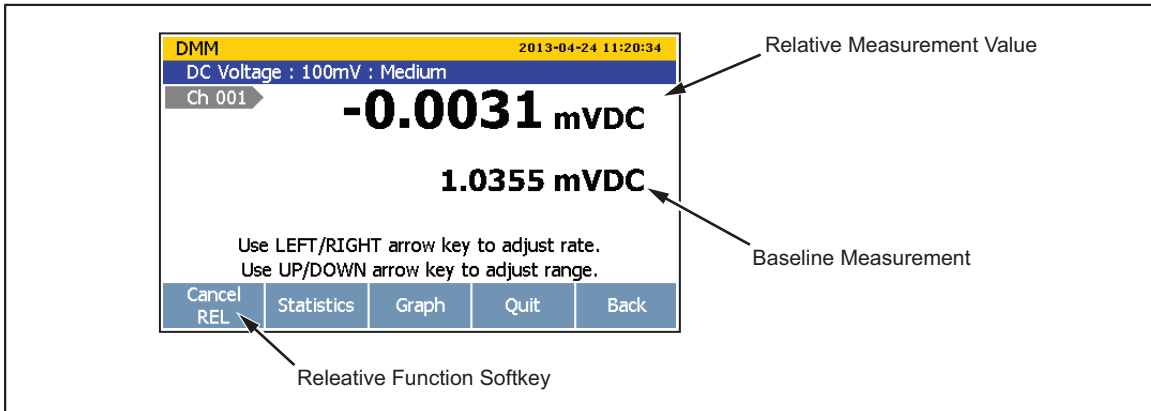

Figure 5-3. Relative Measurement

hcn054.eps

Graph the Measurements

The DMM has a graph feature that lets the user display the measurement data in a graph. The graph has features such as History mode and Live mode to let the user evaluate the data on the display. The graph automatically scales to fit all the information on the display when opened. To refine the data, the graph can be manipulated with the arrow keys as shown in Figure 5-4.

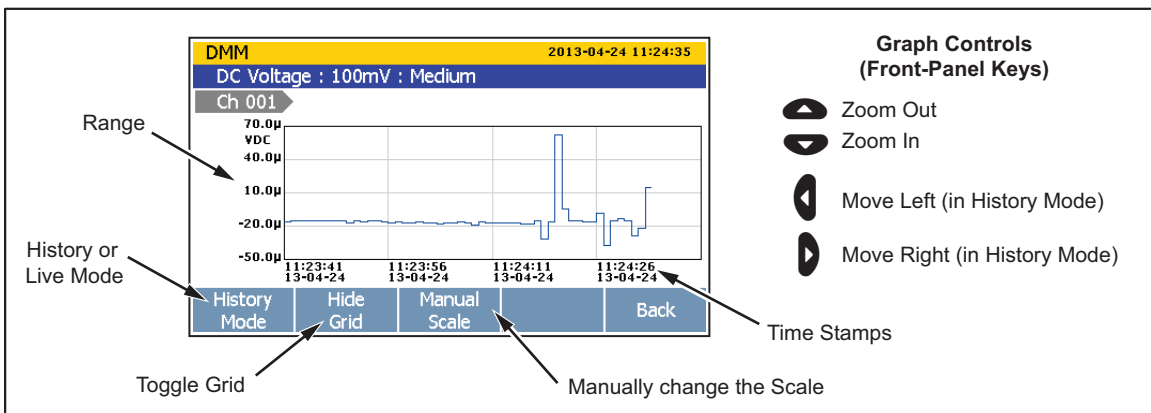

Figure 5-4. Graph Function

hcn055.eps

To see the measurement data in a graph:

1. Push **MEASURE DMM**.
2. Push **F5** to open the DMM Menu.
3. Configure the input.

4. Push **F5** to show the channel options.
5. Push **F3** to show the graph. Use and to zoom in and out. To see historical data, push **F1** to switch between History Mode and Live Mode. When in History Mode, use and to move the graph left and right.

Measurement Statistics

The DMM has a statistics feature that lets the user see statistical information for the measurements made. Table 5-1 lists the statistics available along with a brief description. The statistics start when the user pushes the key or the statistics are reset.

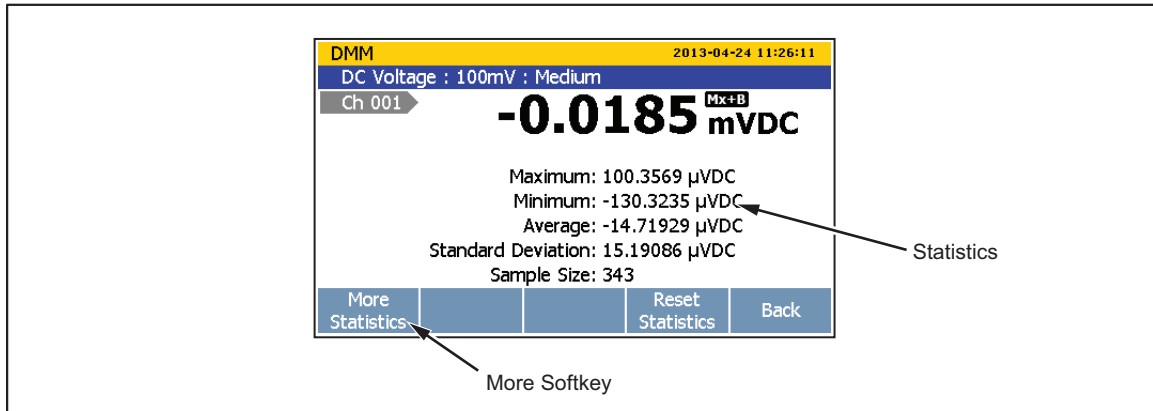

Figure 5-5. DMM Statistics

hcn056.eps

Table 5-1. Statistics

| Statistic | Description |
|--------------------|---|
| Maximum | Maximum measurement. |
| Minimum | Minimum measurement. |
| Average | Average of all the measurements taken. |
| Standard Deviation | A measure of the distribution of a set of data from its mean. The more spread apart the data, the higher the deviation. |
| Sample Size | The number of readings used in the statistical calculations. |
| Rate of Change | A measure of how much the readings change over time. |
| Peak to Peak | Difference between the Maximum and the Minimum. |

To see the statistics data:

1. Push .
2. Push **F5** to open the DMM Menu.
3. Configure the input.
4. Push **F5** to show the channel options.
5. Push **F2** to show the statistics. Push **F1** to view more statistics. To reset the statistics, push **F4**.

Chapter 6

Maintenance and Care

| Title | Page |
|--|-------------|
| Introduction..... | 6-3 |
| Clean the Product..... | 6-3 |
| Replace the Fuse | 6-3 |
| Memory Reset and Factory Reset | 6-4 |
| User-Replaceable Parts and Accessories | 6-5 |

Introduction

This section supplies information on how to clean the Product, reset the memory, and replace the fuse in the rear of the Product.

Clean the Product

To clean the Product, wipe the instrument with a cloth that is lightly dampened with water or mild detergent. Do not use aromatic hydrocarbons, chlorinated solvents, or methanol based fluids.

Replace the Fuse

The Product has a product fuse that protects from overcurrent. Each voltage selection requires a specific fuse. See Table 6-1.

Warning

To prevent possible electrical shock, fire, or personal injury, use only specified replacement parts.

Table 6-1. Fuses

| Voltage Selector | Fuse | Fluke Part Number |
|------------------|----------------------------|-------------------|
| 100 V | 0.25 A, 250 V (slow blow) | 166306 |
| 120 V | 0.25 A, 250 V (slow blow) | 166306 |
| 220 V | 0.125 A, 250 V (slow blow) | 166488 |
| 240 V | 0.125 A, 250 V (slow blow) | 166488 |

To replace the fuses (see Figure 6-1):

1. Disconnect the mains-power cord from the power-entry module.
2. Open the power entry module and remove the fuse holder.
3. Replace the fuses with exact replacements as listed in Table 6-1.

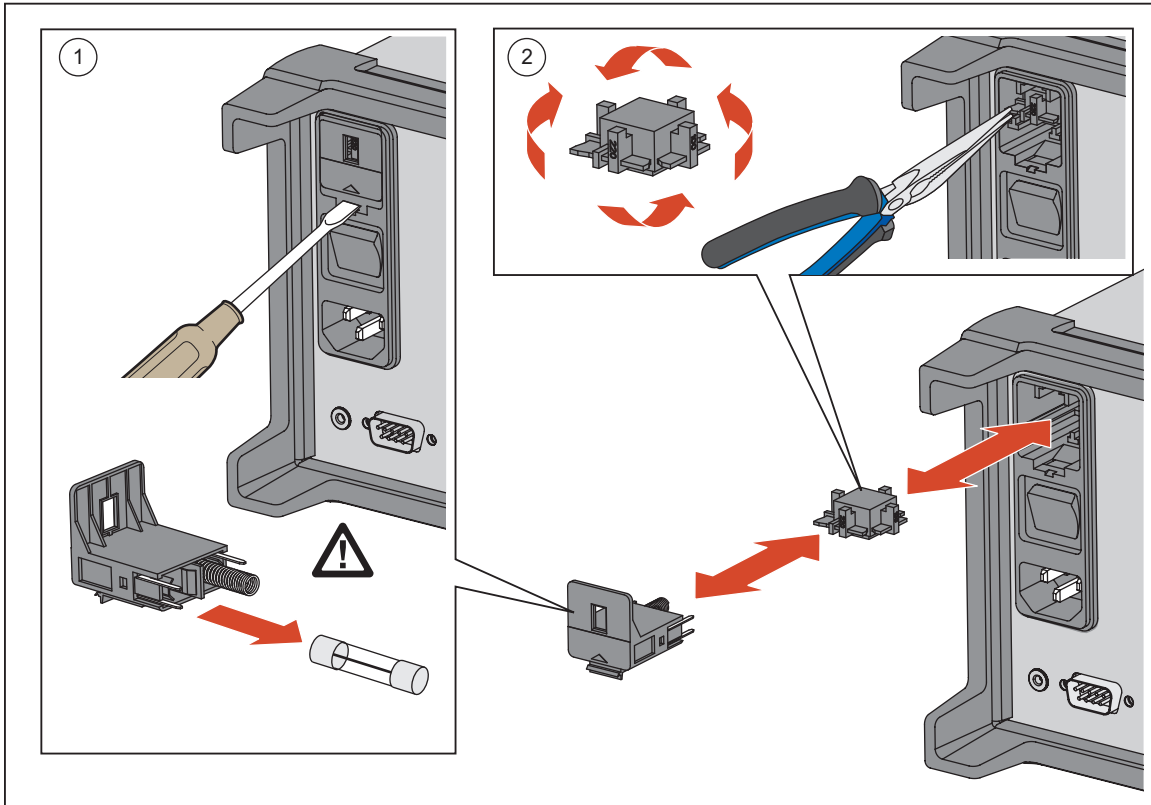

Figure 6-1. Fuse Replacement

hcn027.eps

Memory Reset and Factory Reset

The Product has two memory reset functions to remove data from the memory and to reset the Product: Clear all Files and Factory Reset. See Table 6-2 for a comparison of the three functions.

Note

All memory reset functions require the Admin password to accomplish.

Table 6-2. Comparison of the Memory Clear Functions

| Task | Clear All Files | Factory Reset |
|--|-----------------|---------------|
| Deletes Test Setup files, DMM Data files, and Scan Data files from the internal memory. ^[1] | • | |
| Clears the configuration of the Channel Setup, Test Setup, and Instrument Setup ^[2] | | • |
| Notes: [1] – Does not remove data from the USB drive. [2] – Does not reset the MAC address, the serial number, calibration, clock time, nor the Admin or User passwords. | | |

To Clear all Files:

1. Push **MEMORY**.
2. Push **F1**.
3. Push **F1**.
4. Enter the Admin password, then push **F4**.
5. Push **F3** to confirm.



To reset the Product to factory settings:

1. Push **INSTRUMENT SETUP**.
2. Push **F2**.
3. Enter the Admin password, then push **F4**.

User-Replaceable Parts and Accessories

Table 6-3 lists the part numbers of each user-replaceable part or accessory for the Product.

Table 6-3. User-Replaceable Parts and Accessories

| Part Number | Name | Quantity |
|--|--|------------------|
| Contact Fluke | Transit Case | 1 |
| Contact Fluke | OPC Server software for 1586A | 1 |
| Contact Fluke | DIO/ALARM connectors for 1586A | 1 |
| 4298499 | USB Cable | 1 |
| 4121552 | USB Drive (4 GB) | 1 |
| 4298486 | RS-232 Cable | 1 |
| 2675487 | 884X-ETH Ethernet Interface Cable, 1 Meter | 1 |
| 3980562 | TL71 Test Lead Set | 1 |
| 4281980 | Protective Rubber Boot (front) | 1 |
| 4281971 | Protective Rubber Boot (rear) | 1 |
| 4281998 | Handle | 1 |
| 4308745 | Protective Slot Cover | 1 |
| 166306  | Fuse 0.25A, 250V (slow blow) ^[2] | 1 |
| 166488  | Fuse 0.125A, 250V (slow blow) ^[2] | 1 |
| Contact Fluke | Relay Card | 1 ^[1] |
| Contact Fluke | 1586A High Capacity Input Module | 1 ^[1] |
| Notes: | | |
| [1] – Quantity of items listed can vary based on kit or model ordered. | | |
| [2] – Only use exact replacements. | | |

Chapter 7

Error Messages and Troubleshooting

| Title | Page |
|----------------------|-------------|
| Introduction..... | 7-3 |
| Error Messages | 7-3 |
| Troubleshooting..... | 7-20 |

Introduction

This chapter supplies information on error messages and how to troubleshoot the product.

Error Messages

Error messages help the user diagnose problems with the Product. Error messages contain a message along with an error code. If an error message shows on the display, use the information in Table 7-1 to resolve the problem.

Table 7-1. Error Messages

| Error Code | Error Message | Causes and Solutions |
|------------|-------------------------|---|
| Error -350 | Queue overflow | Cause: The error queue is full because more than 16 errors have occurred. Solution: The error queue is cleared by *CLS (clear status) command or when power is cycled. The errors are also cleared when the queue is read. |
| Error -224 | Illegal parameter value | Cause: A discrete parameter was received that was not a valid choice for this command. Solution: Invalid parameter value used. Check the parameter values and try again. |
| Error -222 | Data out of range | Cause: A numeric parameter value is outside the valid range for this command. Solution: Check the parameter value and try again. |
| Error -213 | INIT ignored | Cause: An INITiate command was received but could not be executed because a scan was already in progress. Solution: Send an ABORt command to stop a scan in progress. |
| Error -211 | Trigger ignored | Cause: More than one trigger was received while the instrument was scanning. Solution: Make sure the proper trigger type is selected. If the problem persists, try to slow down the rate that the trigger occurs. |
| Error -171 | Invalid expression | Cause: The expression data element was invalid. This could be because of an unmatched parentheses or an illegal character. Solution: Check the parameter value and try again. |

Table 7-1. Error Messages (cont.)

| Error Code | Error Message | Causes and Solutions |
|------------|-------------------------|---|
| Error -161 | Invalid block data | Cause: A block data element was expected, but was invalid. For example, an END message was received before the length was satisfied. Solution: Check the command and try again. |
| Error -151 | Invalid string data | Cause: An invalid character string was received. Solution: Check to see if the character string is enclosed in quotation marks and verify that the string contains valid ASCII characters. |
| Error -144 | Character data too long | Cause: The character data element contains more than 250 characters. Solution: Check the parameter value and try again. |
| Error -123 | Exponent too large | Cause: A numeric parameter was found whose exponent was too large for this command. Solution: Check the parameter value and try again. |
| Error -113 | Undefined header | Cause: A command was received that is not valid for this instrument. Solution: The command entered could be misspelled or not a valid command. If the shortened form of a command is used, remember that it can contain up to four letters. Also check for duplicate colons. |
| Error -109 | Missing parameter | Cause: Fewer parameters were received than expected for this command. Solution: One or more parameters that are required for this command have been omitted. Check the parameter value and try again. |
| Error -108 | Parameter not allowed | Cause: More parameters were received than expected for this command. Solution: An extra parameter could have been added to a command that does not require a parameter. Check the parameter value and try again. |
| Error -104 | Data type error | Cause: Invalid data type was found in the command string. Solution: Check the parameter value and try again. |

Table 7-1. Error Messages (cont.)

| Error Code | Error Message | Causes and Solutions |
|------------|---------------------------------------|---|
| Error -102 | Syntax error | Cause: Invalid syntax was found in the command string. Solution: Check the parameter value and try again. |
| Error 0 | No error | Cause: Error queue is empty. No action necessary. |
| Error 100 | Acknowledgement queue full | Cause: GX acknowledgement queue overflow. <i>Note</i> <i>GX is the abbreviation for Guard Crossing - which is the communication link between the inguard and outguard.</i> Solution: Instrument will restart the GX. |
| Error 101 | Inguard not responding (recv) | Cause: Inguard not responding (receive). Solution: Instrument will restart the GX. |
| Error 102 | Lost sync with inguard | Cause: Lost sync with inguard. Solution: Instrument will restart the GX. |
| Error 103 | Inguard not responding (send) | Cause: Inguard not responding (send). Solution: Instrument will restart the GX. |
| Error 104 | Oversize packet received | Cause: Oversize packet received. Solution: The packet will be ignored automatically. |
| Error 105 | GX CRC error | Cause: CRC error detected. Solution: No user action necessary. The packet will be ignored automatically. |
| Error 106 | Wrong ACK number | Cause: An ACK packet was received with unexpected ACK number. Solution: No user action necessary. The Instrument will restart the GX. |
| Error 107 | Info packet received; link not active | Cause: An INFO packet was received, but the communication has not been setup. Solution: No user action necessary. The packet will be ignored automatically. |
| Error 108 | Unknown control byte | Cause: A packet was received with unknown control byte. Solution: No user action necessary. Instrument will restart the GX. |

Table 7-1. Error Messages (cont.)

| Error Code | Error Message | Causes and Solutions |
|------------|--------------------------------|---|
| Error 109 | Unknown ACK byte | Cause: A packet was received, but it is not an acknowledgement. Solution: No user action necessary. The Instrument will restart the GX. |
| Error 110 | Quality indicator too low | Cause: GX quality low. Solution: No user action necessary. The Instrument will restart the GX. |
| Error 111 | GX restart | Cause: GX not responding. Solution: No user action necessary. Instrument will restart the GX. |
| Error 200 | A/D conversion timeout | Cause: A/D conversion timeout. Solution: Cycle the power. If the error occurs again, contact Fluke (see Chapter 1). |
| Error 201 | Error detecting line frequency | Cause: The line frequency is out of range. Solution: Cycle the power. If the error occurs again, contact Fluke (see Chapter 1). |
| Error 202 | A2 memory failed | Cause: Failed to access memory on A2 board, or checksum failure detected in the memory. Solution: Cycle the power. If the error occurs again, contact Fluke (see Chapter 1). |
| Error 203 | Slot 1 module memory failed | Cause: Failed to access memory on module of slot 1, or checksum failure detected in the memory. Solution: Cycle the power. If the error occurs again, contact Fluke (see Chapter 1). |
| Error 204 | Slot 2 module memory failed | Cause: Failed to access memory on module of slot 2, or checksum failure detected in the memory. Solution: Cycle the power. If the error occurs again, contact Fluke (see Chapter 1). |

Table 7-1. Error Messages (cont.)

| Error Code | Error Message | Causes and Solutions |
|------------|--|--|
| Error 207 | Failed to reset relay on slot 1 | Cause: The relay does not reset when the channel is switched. Solution: Cycle the power and try again. If the error occurs again, the relay card needs serviced, contact Fluke (see Chapter 1). |
| Error 208 | Failed to reset relay on slot 2 | |
| Error 209 | Failed to reset relay on slot 3 | |
| Error 210 | Error reading cold junction temperature (Slot 1) | Cause: The CJC temperature cannot be read from external module of slot 1. Solution: Cycle the power. If the error occurs again, the relay card needs serviced, contact Fluke (see Chapter 1). |
| Error 211 | Error reading cold junction temperature (Slot 2) | Cause: The CJC temperature cannot be read from external module of slot 2. Solution: Cycle the power. If the error occurs again, the relay card needs serviced, contact Fluke (see Chapter 1). |
| Error 260 | Error copying configure to ChXXX | Cause: The copy function failed. Solution: Check the channel list and make sure all selected channel are set up correctly. |
| Error 300 | Invalid procedure | Cause: Wrong calibration procedure is specified in CALibrate:START command or MAIN in CALibrate:START command could be misspelled. Solution: Check the parameter value and try again. |
| Error 301 | Invalid procedure step | Cause: Wrong or misspelled calibration step is specified in CALibrate:START command. Solution: Check the parameter value and try again. |
| Error 302 | Step change not allowed while busy | Cause: Invalid CALibrate:START was received while a calibrate operation is in progress. Solution: Send CALibrate:ABORT to terminate the active calibration procedure. |
| Error 303 | Invalid starting point | Cause: The step specified in CALibrate:START command should be the first point of a function or a range, it is invalid to start a calibration procedure from an intermediate step. Solution: Check the start point and try again. |
| Error 304 | Invalid reference unit | Cause: CALibrate:NEXT command was received with an unexpected unit. Solution: Check the parameter value and try again. |
| Error 305 | Entered value out of range | Cause: CALibrate:NEXT command was received, but the reference value is out of range. Solution: Check the parameter value and try again. |

Table 7-1. Error Messages (cont.)

| Error Code | Error Message | Causes and Solutions |
|------------|----------------------------------|---|
| Error 306 | Not waiting for reference | Cause: CALibrate:NEXT command with a reference value was received, but the reference value is not allowed for current step. Solution: Check the parameter value and try again. |
| Error 307 | Continue command ignored | Cause: CALibrate:NEXT command was received, but it is not expected for current calibrate step. Solution: Check the parameter value and try again. |
| Error 318 | Reading does not match reference | Cause: The measured value out of range, it might be caused by wrong input signal or hardware defect. Solution: Make sure that the input signal matches the requirement. If the input signal is correct, cycle the power. If the error occurs again, contact Fluke (see Chapter 1). |
| Error 320 | Timeout waiting for reading | Cause: Timeout while waiting readings from inguard. Solution: Cycle the power. If the error occurs again, contact Fluke (see Chapter 1). |
| Error 322 | Password missing | Cause: CALibrate:ENABLE command was received to unlock the calibration but ADMIN password is not provided. Solution: Make sure that ADMIN password was sent with the CALibrate:ENABLE command. |
| Error 323 | Wrong password | Cause: CALibrate:ENABLE command was received to unlock the calibration but the ADMIN password is wrong. Solution: Make sure that correct ADMIN password was sent with the CALibrate:ENABLE command. |
| Error 324 | Calibration locked | Cause: The calibration is locked when a CALibrate command was received. Solution: Use the CALibrate:ENABLE command to unlock the calibration first. |
| Error 325 | Cannot get stable readings | Solution 1: Check calibrator and make sure that the correct signal is being outputted from the calibrator. Solution 2: Cycle the power and run calibration again. If the error occurs again, the relay card needs serviced, contact Fluke (see Chapter 1). |
| Error 398 | Anomalous error %d | Cause: Unknown error occurred during the calibration procedure. Solution: Restart the calibration procedure. If the error occurs again, contact Fluke (see Chapter 1). |

Table 7-1. Error Messages (cont.)

| Error Code | Error Message | Causes and Solutions |
|------------|--|--|
| Error 399 | Error at step %s | Cause: An error occurred at present calibrating step. Solution: Check next error message for specific solution. |
| Error 400 | External CJC not configured | Cause: A thermocouple channel is set to external CJC, but the channel that is used to measure external CJC temperature has not been configured. Solution: Configure the lowest module channel to PRT or Thermistor with temperature reading, it will be used as external CJC channel. |
| Error 401 | Channel used as external CJC | Cause: Configure is changed to the channel that is used to measure external CJC temperature. Solution: Turn off all thermocouple channels that are configured for external CJC first. |
| Error 402 | TC external reference channel | Cause: Configure the lowest module channel as TC with external CJC. Solution: Check the parameter and make sure that the lowest module channel is not configured as TC with an external CJC. |
| Error 403 | Parameter does not meet present config | Cause: Parameter or command is not allowed for present configuration. For example: SENSE:NPLC 1 (@401) is received, but channel 401 is DIO. Solution: Check the parameter value and try again. |
| Error 404 | Channel limit exceeded | Cause: Too many channels in scan list (max. 178). Solution: Turn off some channels and try again. |
| Error 405 | Channel used as alarm trigger | Cause: A channel cannot be set to OFF while it is used as trigger channel for alarm test. Solution: Change the trigger channel setting or reconfigure the trigger source. |
| Error 406 | Alarm channel not enabled | Cause: The alarm channel selected to be the alarm trigger is set to OFF. Solution: Enable and configure the alarm channel then try again. |

Table 7-1. Error Messages (cont.)

| Error Code | Error Message | Causes and Solutions |
|------------|--|--|
| Error 407 | Reference channel not enabled | Cause: TRIGger:AUTO:REF or TRIGger:AUTO:SREF command is attempting to configure an OFF channel as reference. Solution: Configure the channel which you want to use as reference. |
| Error 408 | Channel used as reference | Cause: A channel cannot be set to OFF while it is used as reference channel for automated test. Solution: Change the reference channel setting or reconfigure the automated test. |
| Error 409 | Reference channel not set | Cause: Automated test is initiated, but reference channel has not been assigned. Solution: Assign a channel as reference channel. |
| Error 410 | Alarm channel not set | Cause: A scan is started but the alarm trigger does not have an alarm channel assigned. Solution: Assign a channel as alarm trigger channel. |
| Error 411 | Pause ignored | Cause: Invalid pause operation while scan has not been initiated. Solution: Pause is only allowed when scan is initiated. |
| Error 412 | Scan list is empty | Cause: No channel is ON while scan is being initiated. Solution: Configure the channels before the scan is started. |
| Error 414 | Current function not available in module | Cause: Chx21 or Chx22 is enabled in the configuration, but the installed Input Modules do not include these channel IDs or the wrong setup file or wrong Input Module is installed. Solution: Check to make sure the Input Modules are installed correctly and registered. See Chapter 2. |

Table 7-1. Error Messages (cont.)

| Error Code | Error Message | Causes and Solutions |
|------------|----------------------------|---|
| Error 415 | Module not connected | <p>Cause: The Instrument attempted an operation but detected that a required Input Module was not installed. This error can also occur if a setup file is loaded without all the Input Modules installed that the setup file requires.</p> <p>Solution: Install the required Input Module and try the operation again. See Chapter 2.</p> |
| Error 416 | Channel unavailable | <p>Cause: The channel is unavailable or reserved for 3-wire or 4-wire use.</p> <p>Solution: Reconfigure the channel that reserved this sense channel for use. See Chapter 3.</p> |
| Error 417 | Active module disconnected | <p>Cause: An Input Module was disconnected. If a scan is was in progress, it will be stopped.</p> <p>Solution: Install the Input Module again then try the test again. If the Input Module was installed when the error occurred, make sure the Input Module is fully seated in the rear panel. See Chapter 2.</p> |
| Error 418 | Monitor state is locked | <p>Cause: Monitor channel or monitor state is changed while an alarm trigger scan or automated test is in progress.</p> <p>Solution: Stop the scan.</p> |
| Error 419 | Read config file failed | <p>Cause: The Instrument could not read the configuration file that contains all the Instrument settings. When this happens, the configurations are reset to factory defaults until the configuration can be read again.</p> <p>Solution: Contact Fluke. See Chapter 1.</p> |
| Error 420 | Not a math channel | <p>Cause: Error occurs when a user attempts to set a math channel on any channel other than Ch501 through Ch520.</p> <p>Solution: Check the parameter value and try again.</p> |
| Error 421 | Not a DIO channel | <p>Cause: Error occurs when a user attempts to set a DIO channel on any channel other than Ch401.</p> <p>Solution: Check the parameter value and try again.</p> |

Table 7-1. Error Messages (cont.)

| Error Code | Error Message | Causes and Solutions |
|------------|---|--|
| Error 422 | Not a totalizer channel | Cause: Error occurs when a user attempts to set a TOT channel on any channel other than Ch402. Solution: Check the parameter value and try again. |
| Error 423 | Not an analog channel | Cause: Error occurs when a user attempts to set an analog channel on any channel other than Chx01 through Chx22. Solution: Check the parameter value and try again |
| Error 424 | 3-wire or 4-wire not allowed on channel | Cause: Channel cannot be configured for 3-wire or 4-wire because (1.) the input type does not support it (2.) the channel is not a dedicated sense channel. Solution: Check to make sure that the sense wires are in the sense terminals and not the input terminals. When a sense is configured, it is configured on the channel associated with the input terminal and automatically reserves the sense channel directly across from the input. See Chapter 2 and Chapter 3 for more information. |
| Error 425 | Function not allowed on current channel | Cause: Chx21 or Chx22 can only be configured as a current channel. Solution: Set up the input on a different channel. |
| Error 427 | Invalid current channel | Cause: An Input Module was swapped with an external Input Module while a scan was paused. Solution: Reinstall the Input Module that was used when the scan was started. |
| Error 428 | Parameter value out of range | Cause: Parameter in command exceeds the limit. Solution: Check the parameter value and try again. |
| Error 429 | Channel limit exceeded | Cause: A single math channel is configured to use more than 10 channels. Solution: Limit the number of math channels to no more than 10 with the CALCulate:MATH:SOURce command. |
| Error 430 | String too long | Cause: Too many characters are included in a string parameter. For example, Probe ID (max. 24 characters); Unit (max. 3 characters); Channel label (max. 16 characters); Test setup file name (max. 8 characters). Solution: Check the parameter value and try again. |

Table 7-1. Error Messages (cont.)

| Error Code | Error Message | Causes and Solutions |
|------------|--|---|
| Error 431 | Invalid setpoint | <p>Cause: Setpoint that is specified in the command is not in range 1 to 20. This could be because of a wrong setpoint in the TRIGger:AUTO:POINTs, TRIGger:AUTO:SPOint, TRIGger:AUTO:TOLerance, TRIGger:AUTO:STABility, TRIGger:AUTO:DWELl commands</p> <p>Solution: Check the parameter value and try again.</p> |
| Error 432 | Input module not installed | <p>Cause: The Input Module is not installed.</p> <p>Solution: Install the Input Module and try again.</p> |
| Error 433 | Recording is automatic | <p>Cause: Recorder is set to OFF while automatic recording is in progress.</p> <p>Solution: Stop the scan or use the ABORt command.</p> |
| Error 434 | Cannot record while idle | <p>Cause: Recorder is started, but a scan has not been started yet.</p> <p>Solution: Use command INITiate to start scan.</p> |
| Error 435 | Only fixed CJC allowed on channel | <p>Cause: Ch001 is being configured to thermocouple with internal or external CJC, that is not supported on this channel.</p> <p>Solution: Set up the input on a different channel.</p> |
| Error 436 | Unavailable operation | <p>Cause: The operation is not supported on specified channel.</p> <p>Solution: Check the parameter value and try again.</p> |
| Error 439 | DIO currently committed to scan | <p>Cause: DIO cannot be used as output while it is included in scan list.</p> <p>Solution: Configure the setpoints.</p> |
| Error 437 | Setpoints not set | <p>Cause: User tried to start an Automated Test without setpoints.</p> <p>Solution: Use command *RST to reset to factory default, or set the DIO channel to OFF.</p> |
| Error 440 | Not able to achieve requested resolution | <p>Cause: The Instrument cannot achieve the requested measurement resolution. Invalid resolution in the CONFigure or MEASure? Command could have been set.</p> <p>Solution: Check the parameter value and try again.</p> |
| Error 441 | Cannot monitor math channel | <p>Cause: The user tried to monitor a math channel. Math channels cannot be monitored.</p> <p>Solution: See the math channel data in the scan data screen.</p> |
| Error 501 | Invalid keyword or choice | <p>Cause: Invalid keyword is found in the command.</p> <p>Solution: Check the parameter value and try again.</p> |

Table 7-1. Error Messages (cont.)

| Error Code | Error Message | Causes and Solutions |
|------------|-------------------------------------|---|
| Error 502 | Temperature unit locked | Cause: UNIT:TEMPerature command is received while the temperature unit is locked to °C. Solution: Contact Fluke. See Chapter 1. |
| Error 527 | Operations not allowed while busy | Cause: Operation cannot be performed while system is busy. Solution: Use *RST command to reset the Instrument to the factory default state. |
| Error 528 | Channel in use for 3-wire or 4-wire | Cause: The channel is unavailable or reserved for 3-wire or 4-wire use. Solution: Reconfigure the channel that reserved this sense channel for use. See Chapter 3. |
| Error 530 | Configuration file corrupt | Cause: The test setup is found corrupted while loading. Solution: Cycle the power and try to reload the setup file. If the error occurs again, load a different file to see if the the single file is corrupted or if the Instrument is malfunctioning. If the error happens with a different file, contact Fluke (see Chapter 1). |
| Error 580 | (STA) begin not called | Cause: Invalid accessing to state. Solution: Cycle the power. If the error occurs again, contact Fluke (see Chapter 1). |
| Error 590 | Cannot get DHCP IP address | Cause: Get an IP address from DHCP server failed. Solution: Make sure a DHCP server is running in your network. |
| Error 600 | (DB) begin not called | Cause: Invalid accessing to database. Solution: Cycle the power. If the error occurs again, contact Fluke (see Chapter 1). |
| Error 601 | (DB) Error initializing data buffer | Cause: Database is not initialized. Solution: Cycle the power. If the error occurs again, contact Fluke (see Chapter 1). |
| Error 602 | (DB) Data buffer overflow | Cause: Database buffer overflow. Solution: Cycle the power. If the error occurs again, contact Fluke (see Chapter 1). |
| Error 603 | (DB) Data not available | Cause: Database empty. Solution: Cycle the power. If the error occurs again, contact Fluke (see Chapter 1). |

Table 7-1. Error Messages (cont.)

| Error Code | Error Message | Causes and Solutions |
|------------|--------------------------------|--|
| Error 651 | USB memory not ready | Cause: USB memory is not ready for data record. Solution: You may have configured the record destination to USB, but the memory is not ready when recording is started. |
| Error 652 | Data file limit exceeded | Cause: Too many data files were created for a scan. Solution: Start a new scan. |
| Error 653 | Error creating record file | Cause: Failed to create file for data record. Solution: Make sure that the destination memory is not full. |
| Error 654 | Error writing record file | Cause: Failed to write file for data record. Solution: Make sure that the destination memory is not full. |
| Error 655 | Error resuming data record | Cause: Failed to resume the data record. Solution: Make sure that the destination memory is not full. |
| Error 656 | Data record limit exceeded | Cause: Too many data records in internal memory (Max.1000). Solution: Remove some data records. |
| Error 657 | Incorrect timestamp | Cause: RTC clock is reset. Solution: Set the instrument's date time setting. |
| Error 658 | Record state damaged | Cause: The battery could have failed. Solution: Replace the battery. |
| Error 700 | NV memory invalid | Cause: The flash memory contains invalid Instrument setup, LAN setup, MAC setup or calibrate constants. Solution: Default settings will be loaded, if the MAC setup or calibrate constants show failed, Contact Fluke. See Chapter 1. |
| Error 701 | NV invalid so default loaded | Cause: Default settings have been loaded. Solution: Cycle the power. If the error occurs again, contact Fluke (see Chapter 1). |
| Error 702 | Error reading instrument setup | Cause: Internal flash is damaged. Solution: Cycle the power. If the error occurs again, contact Fluke (see Chapter 1). |
| Error 703 | Error writing instrument setup | Cause: Internal flash is damaged. Solution: Cycle the power. If the error occurs again, contact Fluke (see Chapter 1). |

Table 7-1. Error Messages (cont.)

| Error Code | Error Message | Causes and Solutions |
|------------|-------------------------------------|--|
| Error 704 | Error reading calibration folder | Cause: Internal flash is damaged. Solution: Cycle the power. If the error occurs again, contact Fluke (see Chapter 1). |
| Error 705 | Error reading calibration history | Cause: Internal flash is damaged. Solution: Cycle the power. If the error occurs again, contact Fluke (see Chapter 1). |
| Error 707 | Error reading calibration constants | Cause: Internal flash is damaged. Solution: Cycle the power. If the error occurs again, contact Fluke (see Chapter 1). |
| Error 708 | Error writing calibration constants | Cause: Internal flash is damaged. Solution: Cycle the power. If the error occurs again, contact Fluke (see Chapter 1). |
| Error 709 | Error restoring LAN settings | Cause: Internal flash is damaged. Solution: Cycle the power. If the error occurs again, contact Fluke (see Chapter 1). |
| Error 710 | Error writing LAN settings | Cause: Internal flash is damaged. Solution: Cycle the power. If the error occurs again, contact Fluke (see Chapter 1). |
| Error 711 | Error setting MAC address | Cause: Internal flash is damaged. Solution: Cycle the power. If the error occurs again, contact Fluke (see Chapter 1). |
| Error 712 | Error storing MAC address | Cause: Internal flash is damaged. Solution: Cycle the power. If the error occurs again, contact Fluke (see Chapter 1). |
| Error 800 | Serial framing error | Cause: RS232 framing error Solution: Make sure that the PC and Instrument settings are the same. |
| Error 821 | LAN port out of range | Cause: The LAN port < 1024 or > 65535. Solution: Check the port address and try again. |
| Error 822 | Error opening LAN port | Cause: Error while opening LAN port. Solution: Cycle the power. If the error occurs again, contact Fluke (see Chapter 1). |
| Error 824 | LAN port receive error | Cause: Error while reading LAN port. Solution: Check the LAN connection. |

Table 7-1. Error Messages (cont.)

| Error Code | Error Message | Causes and Solutions |
|------------|--------------------------------|--|
| Error 825 | LAN address invalid | Cause: Invalid IP, mask or gateway address was found. Solution: Check the address and try again. |
| Error 826 | LAN hostname invalid | Cause: The hostname contains invalid character. The Instrument only allows 'A' to 'Z', '0' to '9' and '-'. Solution: Check the parameter and try again. |
| Error 827 | LAN hostname too long | Cause: More than 20 characters were found when configuring hostname. Solution: Check the parameter and try again. |
| Error 828 | LAN connection timeout | Cause: The LAN connection has been disconnected. Solution: Check the LAN equipment and try to connect again. |
| Error 901 | File not found | Cause: File not found for memory operation. Solution: Check to make sure the file is in the memory. |
| Error 903 | Error exporting file | Cause: Failed while exporting file to USB memory. Solution: Make sure that the USB memory is not write protected and that the USB memory has enough free space. |
| Error 904 | Error deleting file | Cause: Failed while deleting file. Solution: If you are delete file from USB memory, make sure that the USB memory is not write-protected. |
| Error 905 | Error reading file | Cause: The file has been damaged. Solution: Cycle the power. If the error occurs again, contact Fluke (see Chapter 1). |
| Error 906 | Error defining setup file name | Cause: Duplicate filename was found. Solution: Try another name or remove the file with the conflict. |
| Error 907 | Error reading folder | Cause: Folder not exist. Solution: Make sure that the folder is in the memory. |
| Error 908 | Error writing file | Cause: Failed while writing file. Solution: Make sure that the USB memory is not write protected and that the USB memory has enough free space. |
| Error 909 | File already exists | Cause: The destination already exists while a file with the same name. Solution: Try another name or remove the file with the conflict. |

Table 7-1. Error Messages (cont.)

| Error Code | Error Message | Causes and Solutions |
|------------|------------------------------------|---|
| Error 910 | File locations full | Cause: The number of setup file reaches the limit (99). Solution: Remove some setup files. |
| Error 1302 | Bad parameter count | Cause: The number of parameter does not match the command. Solution: Check the parameter and try again. |
| Error 1305 | Illegal parameter unit | Cause: Illegal parameter unit was specified in the command. The valid parameter unit is UV, MV, V, KV, UA, MA, A, OHM, KOHM, MOHM, GOHM, TOHM, HZ, KHZ, MHZ, GHZ, CEL, FAR. Solution: Check the parameter and try again. |
| Error 1313 | Operation only allowed for service | Cause: The service only command was received while service mode is not activated. Solution: Enter service mode and try the operation again. |
| Error 1315 | Invalid device trigger | Cause: An invalid bus trigger *TRG was received. Solution: Input Ctrl+T when input buffer is not empty. |
| Error 1317 | Communication input buffer overrun | Cause: Input buffer overrun for communication. Solution: Cycle the power. If the error occurs again, contact Fluke (see Chapter 1). |
| Error 1320 | Invalid binary data | Cause: An invalid binary data parameter was found in the command. Solution: Check the parameter and try again. |
| Error 1323 | Invalid decimal data | Cause: An invalid decimal data parameter was found in the command. Solution: Check the parameter and try again. |
| Error 1326 | Invalid hexadecimal data | Cause: An invalid hexadecimal data parameter was found in the command. Solution: Check the parameter and try again. |
| Error 1328 | Invalid octal data | Cause: An invalid octal data parameter was found in the command. Solution: Check the parameter and try again. |

Table 7-1. Error Messages (cont.)

| Error Code | Error Message | Causes and Solutions |
|------------|-----------------------------------|---|
| Error 1331 | Command incomplete | Cause: An incomplete command line was received. Solution: Make sure that correct command was sent. |
| Error 1333 | Invalid channel number | Cause: Invalid channel number was found by command parser. This could be caused by a wrong format. Solution: Check the parameter and try again. |
| Error 1334 | Illegal channel count | Cause: The number of channels exceeds the limit when parse the channel list. Solution: Check the parameter and try again. |
| Error 1337 | Operation not allowed | Cause: Operation is not allowed for current configuration, and the channel is not in scan list. Make sure that you have input the command with correct parameters and channel ID. Solution: Check the parameter and try again. |
| Error 1338 | Operation not allowed in DMM mode | Cause: Operation is not allowed in DMM mode. Solution: Use command *RST to reset to factory default. |
| Error 1339 | Memory is empty | Cause: Command DATA:LAST? or DATA:READ? was received, but data is not available. Solution: Check the trigger settings, and make sure that the Instrument is properly triggered for scan. |
| Error 1340 | File name too long | Cause: More than 30 characters were found in filename which specified in command MEM:LOG:READ? or MMEM:LOG:READ? Solution: Check the parameter and try again. |
| Error 1341 | Scan sweep in process | Cause: Operation not allowed while scan is in progress. Solution: Send command ABORt to stop the scan. |
| Error 1601 | Error copying file | Cause: File coping failed while running SYSTem:DFU command because source is missing. Solution: Check to see if the file is in the memory. |
| Error 1602 | Error modifying file property | Cause: Failed to change file property while running SYSTem:DFU command. Solution: Cycle the power. If the error occurs again, contact Fluke (see Chapter 1). |
| Error 1603 | USB memory not ready | Cause: USB drive not ready for recording or memory operations. Solution: Install the USB drive. See Chapter 2. |

Troubleshooting

In the event that the Product functions abnormally, Table 7-2 can help find and solve the problem. Several possible problem conditions are described with likely causes and solutions. If a problem occurs, please read this section carefully and attempt to understand and solve the problem. If the Product seems faulty or the problem cannot otherwise be solved, contact an Authorized Service Center for assistance, see Chapter 1. Be sure to have the instrument model number, serial number, and regional voltage available to tell the Service Technician.

Table 7-2. Troubleshooting Chart

| Problem | Causes and Solutions |
|--|---|
| The Product does not power on. | <p>Cause 1: Fuses. Solution 1: If a fuse blows, it could be because of a power surge or a component failure. Replace the fuse once. DO NOT replace the fuse with one of a higher current rating. Always replace the fuse with one of the same rating, voltage, and type. If the fuse blows a second time, it is likely caused by failure of a component part.</p> <p>Cause 1: Power Cord. Solution 1: Check that the power cord is plugged in and connected to the Product.</p> <p>Cause 2: AC mains power. Solution 2: Make sure the circuit that supplies power to the Product is on.</p> <p>Cause 3: Power entry is not properly set. Solution 3: Make sure the power entry setting is matching with the AC mains power supply rate.</p> |
| LED lights are illuminated but the display is blank. | <p>Cause 1: The unit is standby mode (the power LED should be amber). Solution 1: Press the Standby key on the front panel to exit the standby mode.</p> <p>Cause 2: Screen saver activated. Solution 2: Press any front panel key to exit the screen saver.</p> <p>Cause 3: Screen or unit is malfunctioning. Solution 3: Contact Fluke. See Chapter 1.</p> |
| Input Module is not recognized. | <p>Cause 1: Input Module not fully seated. Solution 1: Reinstall the Input Module and make sure it is fully seated in the slot.</p> <p>Cause 2: Relay card not installed. Solution 2: Make sure the relay card is installed.</p> <p>Cause 3: Input Module has failed. Solution 3: Contact an Authorized Customer Service Center.</p> |

Table 7-2. Troubleshooting Chart (cont.)

| Problem | Causes and Solutions |
|---|---|
| Cannot read USB drive. | <p>Cause 1: USB drive not installed properly. Solution 1: Make sure the USB drive is fully inserted. The LED light will illuminate in less than 30 seconds.</p> <p>Cause 2: USB driver locked by application (LED lights always illuminated even if USB drive is not installed.) Solution 2: Cycle the power with the main power switch and insert the USB drive again.</p> <p>Cause 3: USB drive not recognized. Solution 3: Replace the USB drive.</p> <p>Cause 4: USB drive inoperative or damaged. Solution 4: Replace USB drive.</p> |
| Product does not start to scan after the scan is started. | <p>Cause 1: The Product is waiting to be triggered. Solution 1: Check the trigger type in the test setup and make sure the trigger is properly configured.</p> |
| Product does not record when I start a scan. | <p>Cause 1: The Auto Recording feature is not turned on. Solution: Manually push record to start recording or turn on Auto Recording in the test setup.</p> |
| The Product starts with default settings. | <p>Cause: The SRAM battery is dead. Solution: Contact Fluke. See Chapter 1.</p> |
| Product is out of memory. | <p>Cause: The internal memory or USB drive is out of space. Solution: Delete or transfer some files to free up memory.</p> |