

**FLUKE**®

**Hart Scientific**®

***1523, 1524***  
*Thermometer Readout*  
*User's Guide*



## **Limited Warranty & Limitation of Liability**

Each product from Fluke Corporation, Hart Scientific Division (“Hart”) is warranted to be free from defects in material and workmanship under normal use and service. The warranty period is one year(s) for the Reference Thermometer. The warranty period begins on the date of the shipment. Parts, product repairs, and services are warranted for 90 days. The warranty extends only to the original buyer or end-user customer of a Hart authorized reseller, and does not apply to fuses, disposable batteries or to any other product, which in Hart’s opinion, has been misused, altered, neglected, or damaged by accident or abnormal conditions of operation or handling. Hart warrants that software will operate substantially in accordance with its functional specifications for 90 days and that it has been properly recorded on non-defective media. Hart does not warrant that software will be error free or operate without interruption. Hart does not warrant calibrations on the Reference Thermometer.

Hart authorized resellers shall extend this warranty on new and unused products to end-user customers only but have no authority to extend a greater or different warranty on behalf of Hart. Warranty support is available if product is purchased through a Hart authorized sales outlet or Buyer has paid the applicable international price. Hart reserves the right to invoice Buyer for importation costs of repairs/replacement parts when product purchased in one country is submitted for repair in another country.

Hart’s warranty obligation is limited, at Hart’s option, to refund of the purchase price, free of charge repair, or replacement of a defective product which is returned to a Hart authorized service center within the warranty period.

To obtain warranty service, contact your nearest Hart authorized service center or send the product, with a description of the difficulty, postage, and insurance prepaid (FOB Destination), to the nearest Hart authorized service center. Hart assumes no risk for damage in transit. Following warranty repair, the product will be returned to Buyer, transportation prepaid (FOB Destination). If Hart determines that the failure was caused by misuse, alteration, accident or abnormal condition or operation or handling, Hart will provide an estimate or repair costs and obtain authorization before commencing the work. Following repair, the product will be returned to the Buyer transportation prepaid and the Buyer will be billed for the repair and return transportation charges (FOB Shipping Point).

THIS WARRANTY IS BUYER’S SOLE AND EXCLUSIVE REMEDY AND IS IN LIEU OF ALL OTHER WARRANTIES, EXPRESS OR IMPLIED, INCLUDING BUT NOT LIMITED TO ANY IMPLIED WARRANTY OF MERCHANTABILITY OR FITNESS FOR A PARTICULAR PURPOSE. HART SHALL NOT BE LIABLE FOR ANY SPECIAL, INDIRECT, INCIDENTAL, OR CONSEQUENTIAL DAMAGES OR LOSSES, INCLUDING LOSS OF

DATA, WHETHER ARISING FROM BREACH OF WARRANTY OR BASED ON CONTRACT, TORT, RELIANCE OR ANY OTHER THEORY.

Since some countries or states do not allow limitation of the term of an implied warranty, or exclusion or limitation of incidental or consequential damages, the limitations and exclusions of this warranty may not apply to every buyer. If any provision of this Warranty is held invalid or unenforceable by a court of competent jurisdiction, such holding will not affect the validity or enforceability of any other provision.

---

## Table of Contents

|          |                                     |          |
|----------|-------------------------------------|----------|
| <b>1</b> | <b>Before You Start .....</b>       | <b>1</b> |
| 1.1      | Introduction.....                   | 1        |
| 1.2      | Standard Equipment.....             | 1        |
| 1.3      | Safety Information.....             | 2        |
| 1.3.1    | ⚠ Warning .....                     | 2        |
| 1.3.2    | Cautions .....                      | 3        |
| 1.4      | CE Comments.....                    | 5        |
| 1.4.1    | EMC Directive .....                 | 5        |
| 1.4.2    | Immunity Testing .....              | 5        |
| 1.5      | Using Clamp-On Ferrites .....       | 5        |
| 1.6      | Emissions Testing .....             | 6        |
| 1.7      | Low Voltage Directive (Safety)..... | 6        |
| 1.8      | Authorized Service Centers .....    | 7        |
| <b>2</b> | <b>Quick Start.....</b>             | <b>9</b> |
| 2.1      | Setup.....                          | 9        |
| 2.2      | Specifications .....                | 24       |

## Figures

|  |    |
|--|----|
| Figure 1 Clamp-On Ferrite .....                | 6  |
| Figure 2 Input/Output Connections - 1523 ..... | 9  |
| Figure 3 Input/Output Connections - 1524 ..... | 10 |
| Figure 4 Keys.....                             | 11 |
| Figure 5 1523 Menu.....                        | 14 |
| Figure 6 1523 Menu (cont) .....                | 15 |
| Figure 7 1523 Menu (cont) .....                | 16 |
| Figure 8 1524 Menu.....                        | 19 |
| Figure 9 1524 Menu (cont) .....                | 20 |
| Figure 10 1524 Menu (cont) .....               | 21 |
| Figure 11 1524 Menu (cont) .....               | 22 |
| Figure 12 1524 Menu (cont) .....               | 23 |
| Figure 13 1524 Menu (cont) .....               | 24 |

---

## Tables

|  |    |
|--|----|
| Table 1 International Symbols.....                             | 4  |
| Table 2 1523 Input/Output Connections .....                    | 9  |
| Table 3 1524 Input/Output Connections .....                    | 10 |
| Table 4 1523 Key Functions.....                                | 12 |
| Table 5 1524 Key Functions.....                                | 17 |
| Table 6 General Specifications .....                           | 24 |
| Table 7 Millivolt Measurement.....                             | 25 |
| Table 8 Ohms Measurement, RTDs .....                           | 25 |
| Table 9 Ohms Measurement, Thermistor .....                     | 26 |
| Table 10 Temperature, Thermocouples .....                      | 26 |
| Table 11 Temperature, RTD Ranges, and Accuracies (ITS-90)..... | 28 |
| Table 12 Temperature, Thermistor .....                         | 28 |





# 1 Before You Start

## 1.1 Introduction

The Reference Thermometer Readouts (1523, 1524) are designed to be reliable, stable, temperature measuring instruments that can be used in the field or laboratory. They offer accuracy, portability, and speed for nearly every field calibration application. The instruments have been designed with the field user in mind and are easy to use while maintaining stability, uniformity, and accuracy comparable to some laboratory instruments. Your Fluke 1523 and 1524 thermometer readout is a handheld, battery operated instrument that measures temperature using Platinum resistance Thermometers (PRT), Thermistors, and Thermocouples (TC).

## 1.2 Standard Equipment

Unpack the instrument carefully and inspect it for any damage that may have occurred during shipment. If there is shipping damage, notify the carrier immediately.

Verify that the following components are present:

- 1523/1524 Reference Thermometer Readout with 3 AA batteries
- AC Adapter, with power cord
- RS-232 Cable
- User's Guide
- Documentation CD
- Report of Calibration and calibration label
- Clamp-on ferrite(s)

If all items are not present, contact an Authorized Service Center. (See Section 1.8, Authorized Service Centers on page 7.)

### 1.3 Safety Information

The Reference Thermometer is designed in accordance with EN 61010-1 {2nd Edition}, and CAN/CSA 22.2 No 61010.1-04. Use this instrument only as specified in this manual, otherwise the protection provided by the instrument may be impaired.

A **Warning** identifies conditions and actions that pose hazard(s) to the user; a **Caution** identifies conditions and actions that may damage the instrument being used.

International symbols used on the reference thermometer and in this manual are explained in Table 1 on page 4.

#### 1.3.1 Warning

To avoid possible electric shock or personal injury:

- Do not use the reference thermometer in environments other than those listed in the user's guide.
- Do not use the reference thermometer for any application other than that which is specified. The instrument was designed for temperature measurement and calibration. Any other use of the instrument may cause unknown hazards to the user.
- If the reference thermometer is used in a manner not in accordance with the equipment design, the operation and the protection provided by the instrument may be impaired. In addition, safety hazards may arise.
- Do not apply more than the rated voltage, as marked on the reference thermometer, between the inputs, or between any input and earth ground (30 V, 24 mA max all terminals).
- Follow all equipment safety procedures.
- Calibration equipment should only be used by trained personnel.
- The reference thermometer is intended for indoor use only.
- Before you use the instrument, inspect the case. Look for cracks or missing plastic. Pay particular attention to the insulation surrounding the connectors. Do not use the reference thermometer if it

appears damaged or operates abnormally. Protection may be impaired. When in doubt, have the instrument serviced.

- Always use an isolated RTD or PRT (metal sheath isolated from lead wires).
- Make sure the battery door is closed and latched before you operate the reference thermometer.
- Do not operate the reference thermometer around explosive gas, vapor, or dust.
- For battery operation use only 3 AA batteries, properly installed in the reference thermometer case.
- 1524 model, thermocouples can only be used on channel 1.

### **1.3.2 Cautions**

















To avoid possible damage to the reference thermometer or to equipment under test:

- Do not apply more than the rated voltage, as marked on the reference thermometer, between the inputs, or between any input and earth ground (30 V 24 mA max all terminals).
- Unless recalibrating the instrument DO NOT change the values of the calibration constants from the factory set values. The correct setting of these parameters is important to the safety and proper operation of the instrument.
- The instrument and any thermometer probes used with it are sensitive instruments that can be easily damaged. Always handle these devices with care. DO NOT allow them to be dropped, struck, stressed, or overheated.
- DO NOT operate this instrument in an excessively wet, oily, dusty, or dirty environment.
- Use the proper probes, function and range for your measurement.
- Ensure probe coefficients are downloaded.

# 1523, 1524 Thermometer Readout

## Safety Information

**Table 1** International Symbols

| Symbol  | Description                             | Symbol  | Description  |
|---|---|---|--|
|  | AC (Alternating Current)                |  | PE Ground  |
|  | AC-DC                                   |  | Hot Surface (Burn Hazard)  |
|  | Battery                                 |  | Read the User's Guide (Important Information)  |
|  | Complies with European Union directives |  | Off  |
|  | DC                                      |  | On   |
|  | Double Insulated                        |  | Canadian Standards Association   |
|  | Electric Shock                          |  | C-TICK Australian EMC mark   |
|  | Fuse                                    |  | The European Waste Electrical and Electronic Equipment (WEEE) Directive (2002/96/EC) mark. |

## **1.4 CE Comments**

### **1.4.1 EMC Directive**

Hart Scientific's equipment has been tested to meet the European Electromagnetic Compatibility Directive (EMC Directive, 2004/108/EC ). The Declaration of Conformity for your instrument lists the specific standards to which the unit was tested.

The instrument was designed specifically as a test and measuring device. Compliance to the EMC directive is through EN 61326-1:2006 Electrical equipment for measurement, control and laboratory use – EMC requirements

As noted in the EN 61326-1, the instrument can have varying configurations. The instrument was tested in a typical configuration with shielded RS-232 cables.

### **1.4.2 Immunity Testing**

The instrument was tested to the requirements for laboratory locations.

## **1.5 Using Clamp-On Ferrites**

Clamp-on ferrites are provided for use in improving the instrument's electromagnetic (EM) immunity in environments of excessive EM interference, like areas of heavy industrial equipment. We recommend placing the ferrites on the cables of probes attached to the instrument.

To attach a ferrite to a probe cable, make a loop in the cable near the connector and clamp the ferrite around half of the loop as shown in the diagram. The ferrite can be easily detached and moved to a new probe when needed. (See Figure 1 on next page.)

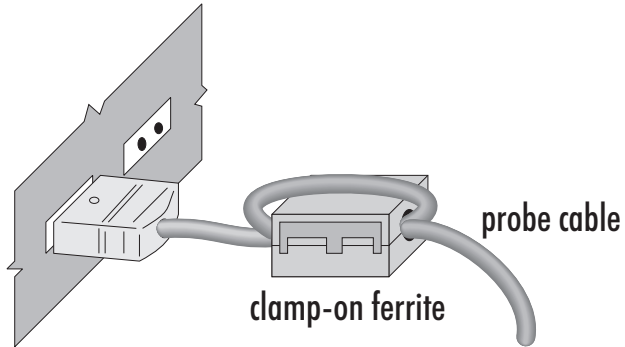

*Figure 1* Clamp-On Ferrite

### 1.6 Emissions Testing

The instrument fulfills the limit requirements for Class B.

### 1.7 Low Voltage Directive (Safety)

In order to comply with the European Low Voltage Directive (2006/95/EC), Fluke equipment has been designed to meet the EN 61010-1.

## **1.8 Authorized Service Centers**

Please contact one of the following authorized Service Center to coordinate service on your Fluke product:

**Fluke Corporation**  
**Hart Scientific Division**

**Fluke Nederland B.V.**

**Fluke Int'l Corporation - CHINA**

**Fluke South East Asia Pte Ltd. - SINGAPORE**

When contacting a Service Center for support, please have the following information available:

- Model Number
- Serial Number
- Complete description of the problem





## 2 Quick Start

### 2.1 Setup

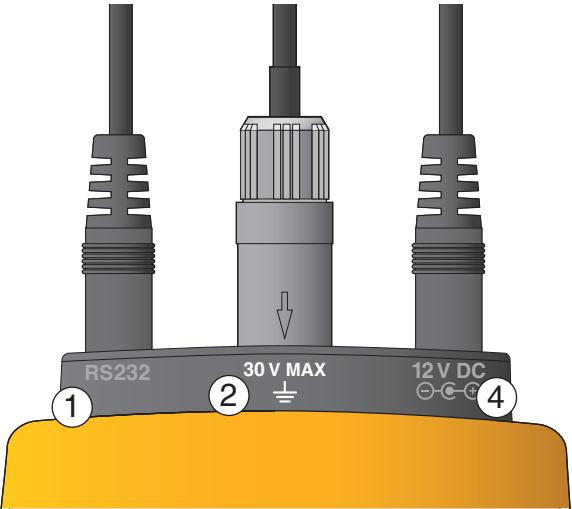

Figure 2 Input/Output Connections - 1523

Table 2 1523 Input/Output Connections

| No. | Name          | Description                       |
|-----|---------------|-----------------------------------|
| 1   | Serial        | Serial interface connector        |
| 2   | Connector, T1 | Sensor Connector, Channel 1       |
| 4   | Power         | External Power adapter connection |

## 1523, 1524 Thermometer Readout

### Setup

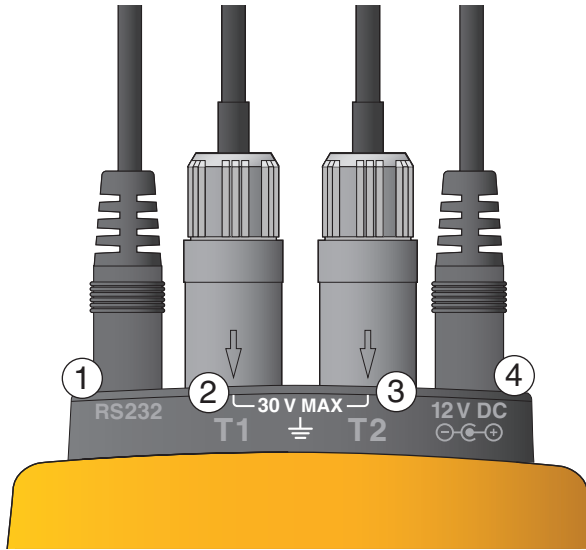

Figure 3 Input/Output Connections - 1524

Table 3 1524 Input/Output Connections

| No | Name          | Description                       |
|----|---------------|-----------------------------------|
| 1  | Serial        | Serial interface connector        |
| 2  | Connector, T1 | Sensor Connector, Channel 1       |
| 3  | Connector, T2 | Sensor Connector, Channel 2       |
| 4  | Power         | External Power adapter connection |























Figure 4 Keys

## 1523, 1524 Thermometer Readout

### Setup

Table 4 1523 Key Functions

| No | Key   | Description   |
|----|---|---|
| 1  |  | Power on or off   |
| 2  |  | Yellow Second or Special Function Key   |
| 3  |  | Turns the backlight on or off   |
| 4  |  | 1st Press: MAX, 2nd Press: MIn, 3rd Press: AVE, 4th Press: STD DEV  |
| 5  |  | Units, °C/°F  |
| 6  |  | 1st press - Holds value on screen "-- HOLD --" across bottom of screen. 2nd press - Releases Screen hold.         |
| 7  |  | Enters setup menu, see menu structure   |
| 8  |  | Saves measurement as a logged data point  |
| 9  |  | Arrows increment or decrement selections in an active field. In Graph Mode, Arrows change the scale of the graph. |
| 10 |  | Selects highlighted selection, Saves a new selection.   |

| No | Key   | Description   |
|----|---|---|
| 11 |    | 1st Press - Enters Recall menu, 2nd Press - Exits Recall Menu                         |
| 12 |    | Moves down to next option on screen.  |
| 13 |  +  | "RESET" - Resets Stats Data   |
| 14 |  +  | "Ω mV" - Toggles from °C to Ω or Ω to °C (PRT, thermistor), °C to mV or mV to °C (TC) |
| 15 |  +  | "TREND" - Starts Graphing data  |
| 16 |  +  | "HOME" Returns user to main screen  |

# 1523, 1524 Thermometer Readout

## Setup

---

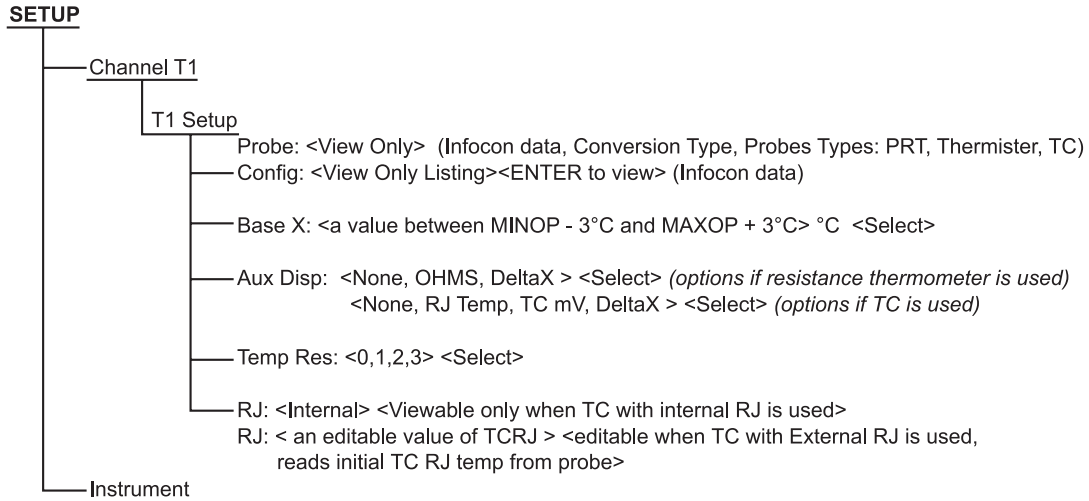
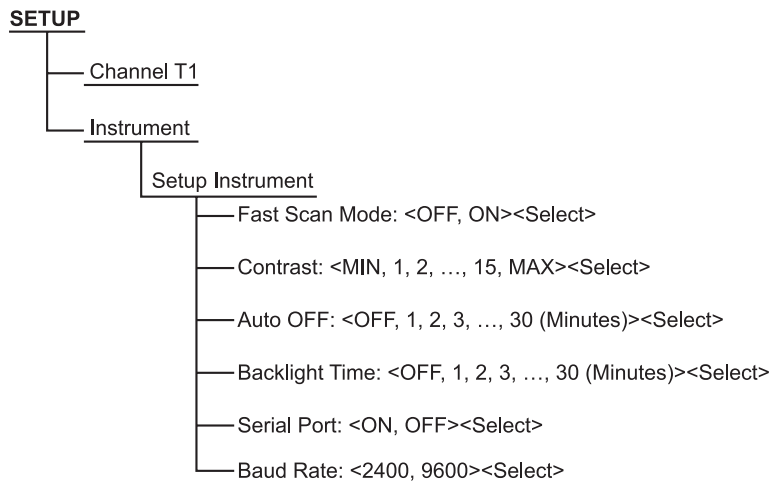

Figure 5 1523 Menu

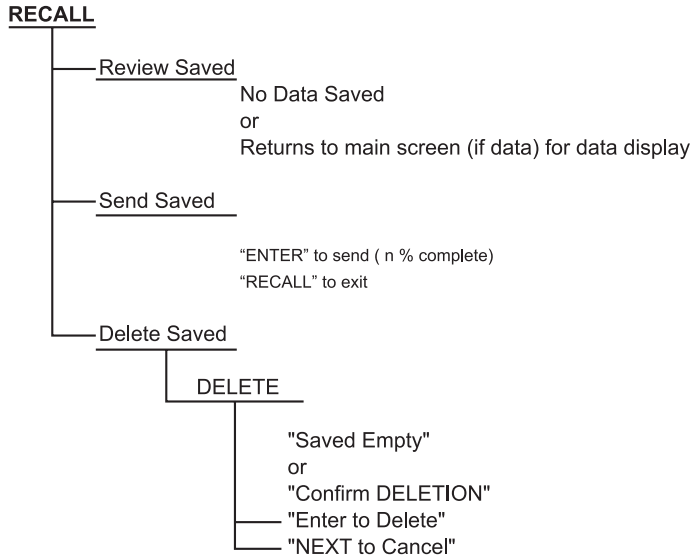

**Figure 6** 1523 Menu (cont)

# 1523, 1524 Thermometer Readout

## Setup









---



**Figure 7** 1523 Menu (cont)















**Table 5** 1524 Key Functions

| No | Key   | Description   |
|----|---|---|
| 1  |  | Power on or off   |
| 2  |  | Yellow Second or Special Function Key   |
| 3  |  | Turns the backlight on or off   |
| 4  |  | 1st Press: Max, 2nd Press: Min, 3rd Press: Ave, 4th Press: STD DEV  |
| 5  |  | Units, °C/°F  |
| 6  |  | 1st press - Holds value on screen "-- HOLD --" across bottom of screen. 2nd press - Releases Screen hold.         |
| 7  |  | Enters setup menu, see menu structure   |
| 8  |  | Saves measurement as a logged data point  |
| 9  |  | Arrows increment or decrement selections in an active field. In Graph Mode, Arrows change the scale of the graph. |

## 1523, 1524 Thermometer Readout

### Setup

| No | Key   | Description   |
|----|---|---|
| 10 |    | Selects highlighted selection, Saves a new selection.                                 |
| 11 |    | 1st press - Enters Recall Menu, 2nd press - Exits Recall Menu                         |
| 12 |    | Moves down to next option on screen.  |
| 13 |  +  | "RESET" - Resets Stats Data   |
| 14 |  +  | "Ω mV" - Toggles from °C to Ω or Ω to °C (PRT, thermistor), °C to mV or mV to °C (TC) |
| 15 |  +  | "TREND" - Starts Graphing data  |
| 16 |  +  | "LOG" - Log a series of measurements, see Auto Log in menu structure                  |
| 17 |  +  | "HOME" Returns user to main screen  |

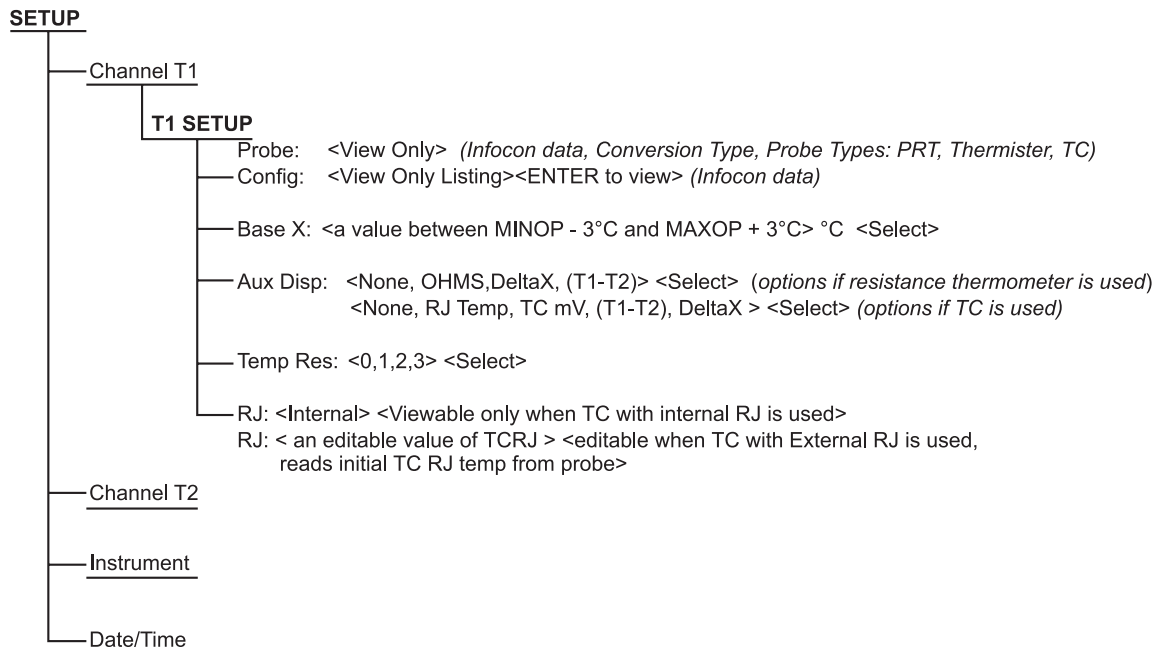
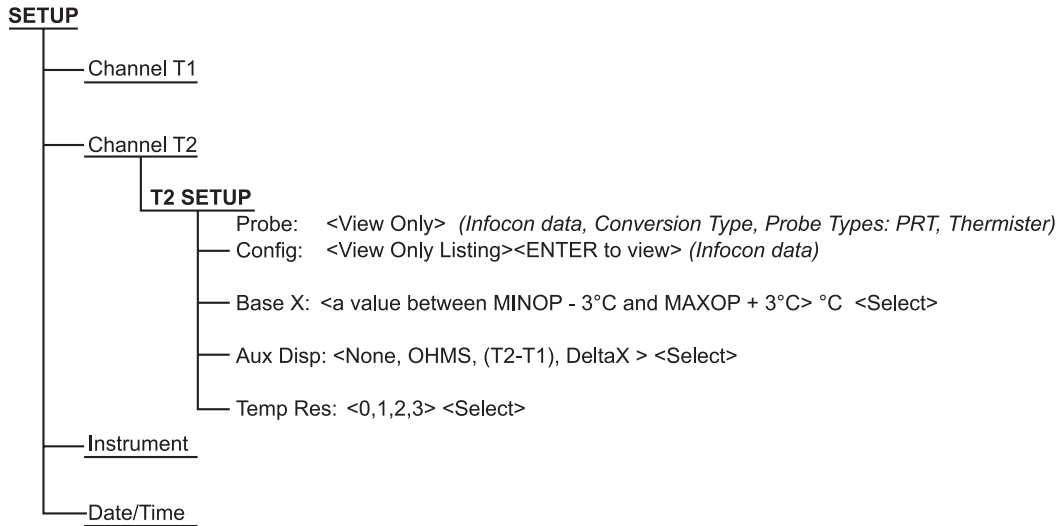

**Figure 8** 1524 Menu

# 1523, 1524 Thermometer Readout

## Setup

---



**Figure 9** 1524 Menu (cont)

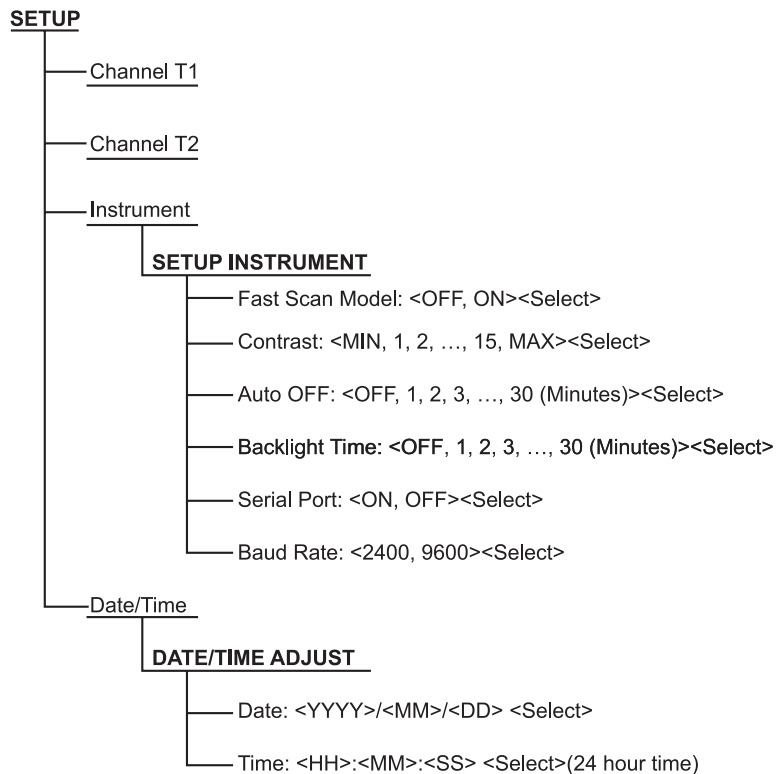
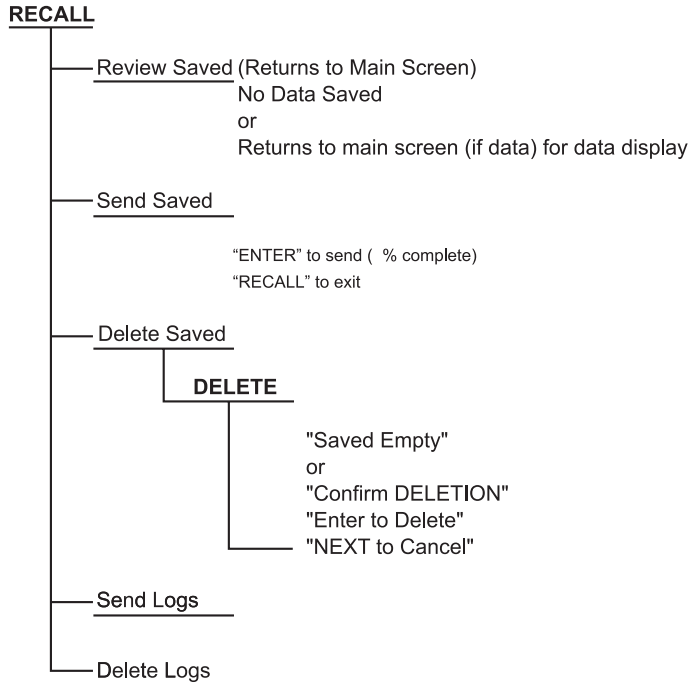

Figure 10 1524 Menu (cont)

# 1523, 1524 Thermometer Readout

## Setup

---



**Figure 11** 1524 Menu (cont)

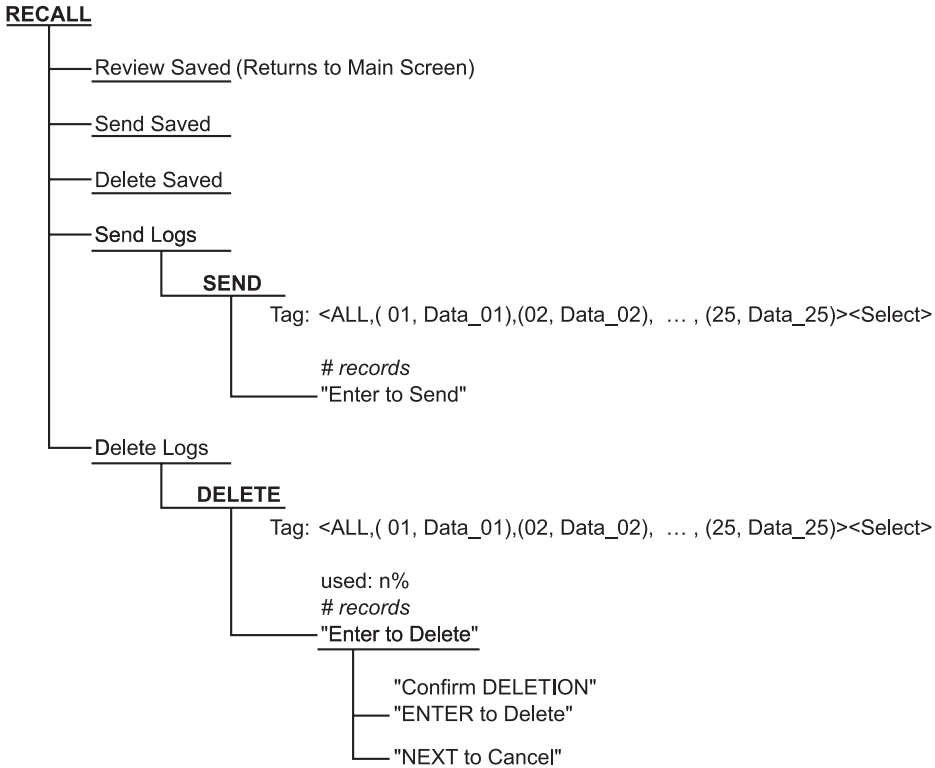

Figure 12 1524 Menu (cont)

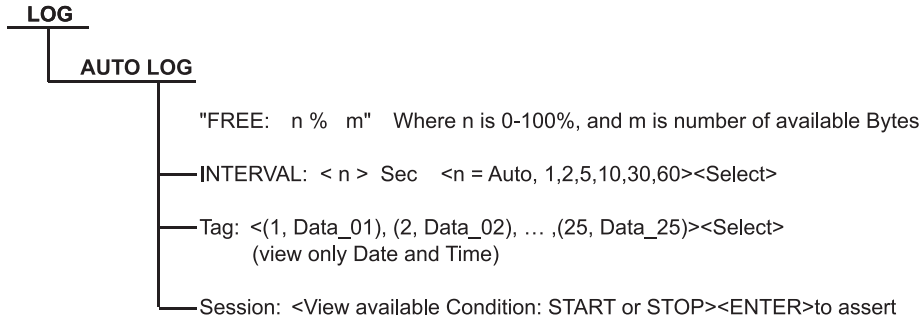

Figure 13 1524 Menu (cont)

## 2.2 Specifications

Specifications are based on a one year calibration cycle and apply from 13 °C to 33 °C unless stated otherwise. All specifications assume a five minute warm up period.

Table 6 General Specifications

|  |                                    |
|--|------------------------------------|
| <b>Operating Temperature<sup>†</sup></b>                       | -10 °C to 60 °C                    |
| <b>Storage Temperature</b>                                     | -20 °C to 70 °C                    |
| <b>Operating altitude</b>                                      | 10,000 meters above mean sea level |
| <b>Relative Humidity (% RH operating without condensation)</b> | 0 % to 90 % (non condensing)       |
| <b>Vibration</b>   | Random, 2g, 5–500 Hz               |



|  |   |
|--|---|
| <b>Power requirements</b>  | 3 AA alkaline batteries<br>12 V dc universal power supply |
| <b>Size</b>  | 96 x 200 x 47 mm<br>(3.75 x 7.9 x 1.86 inches)            |
| <b>Weight</b>  | 0.65 kg (1.4 lb)  |
| <b>Safety</b>  | EN 61010-1:2001, CAN/CSA C22.2 No. 61010.1-04             |
| †Environmental conditions for all specifications: 13 °C to 33 °C |   |

**Table 7** Millivolt Measurement

| <b>Range</b>  | <b>Resolution</b> | <b>Accuracy</b>    |
|---|-------------------|--------------------|
| -10 mV to 75 mV   | 0.001 mV          | ± (0.005 % + 5 μV) |
| <b>Temperature Coefficient ( -10 °C to 13 °C, +33 °C to 60 °C):</b> |                   |                    |
| ± (0.001 %/°C + 1 μV/°C)  |                   |                    |

**Table 8** Ohms Measurement, RTDs

| <b>Ohms Range</b>  | <b>Accuracy ± Ω<br/>4 Wire</b> |
|--|--------------------------------|
| 0 Ω to 400 Ω   | ± (0.004 % + 0.002 Ω)          |
| Temperature Coefficient ( -10 °C to 13 °C, +33 °C to 60 °C): |                                |
| 0.0008 %/°C + 0.0004 Ω                                       |                                |
| <b>Excitation Current:</b> 1 mA                              |                                |

## 1523, 1524 Thermometer Readout

### Specifications

---

**Table 9** Ohms Measurement, Thermistor

| Ohms Range  | Accuracy $\pm \Omega$ , 4 Wire  |
|---|---|
| 200 $\Omega$ to 50 k $\Omega$                                 | $\pm (0.01 \% + 0.5 \Omega)$  |
| 50 k $\Omega$ to 500 k $\Omega$                               | $\pm (0.03 \%)$   |
| Temperature Coefficient ( -10 °C to 13 °C , +33 °C to 60 °C): |   |
| 0.002 %/°C + 0.1 $\Omega$ (0 $\Omega$ to 50 k $\Omega$ )      |   |
| 0.06 %/°C + 0.1 $\Omega$ (50 k $\Omega$ to 500 k $\Omega$ )   |   |
| <b>Excitation Current:</b>                                    | 10 $\mu$ A (0 $\Omega$ to 50 k $\Omega$ )<br>2 $\mu$ A (50 k $\Omega$ to 500 k $\Omega$ ) |

**Equivalent temperature accuracies derived from primary specifications ( $\Omega$ , mV)**

**Table 10** Temperature, Thermocouples

| Type | Range              | Measure Accuracies (ITS-90) |
|------|--------------------|-----------------------------|
| B    | 600 °C to 800 °C   | 0.85 °C                     |
|      | 800 °C to 1000 °C  | 0.68 °C                     |
|      | 1000 °C to 1800 °C | 0.57 °C                     |
| C    | 100 °C to 550 °C   | 0.32 °C                     |
|      | 550 °C to 2300 °C  | 0.71 °C                     |
| E    | -200 °C to 0 °C    | 0.52 °C                     |
|      | 0 °C to 950 °C     | 0.22 °C                     |
| J    | -200 °C to 0 °C    | 0.52 °C                     |
|      | 0 °C to 1200 °C    | 0.23 °C                     |
| K    | -200 °C to 0 °C    | 0.61 °C                     |
|      | 0 °C to 1370 °C    | 0.24 °C                     |

| Type  | Range   | Measure Accuracies (ITS-90)   |
|---|---|-------------------------------|
| L   | -200 °C to 0 °C<br>0 °C to 900 °C                     | 0.36 °C<br>0.23 °C            |
| M   | -20 °C to 0 °C<br>0 °C to 400 °C<br>400 °C to 1400 °C | 0.26 °C<br>0.25 °C<br>0.22 °C |
| N   | -200 °C to 0 °C<br>0 °C to 1300 °C                    | 0.72 °C<br>0.28 °C            |
| R   | -20 °C to 0 °C<br>0 °C to 500 °C<br>500 °C to 1750 °C | 1.09 °C<br>0.97 °C<br>0.49 °C |
| S   | -20 °C to 0 °C<br>0 °C to 500 °C<br>500 °C to 1750 °C | 1.05 °C<br>0.95 °C<br>0.56 °C |
| T   | -200 °C to 0 °C<br>0 °C to 400 °C                     | 0.60 °C<br>0.25 °C            |
| U   | -200 °C to 0 °C<br>0 °C to 400 °C                     | 0.54 °C<br>0.24 °C            |
| <b>Resolution: 0.01 °</b>   |   |                               |
| Note 1: Accuracies are based on internal Reference Junction Compensation. Refer to Technical manual for equivalent external reference accuracies. |   |                               |

## 1523, 1524 Thermometer Readout

### Specifications

---

**Table 11** Temperature, RTD Ranges, and Accuracies (ITS-90)

| <b>Accuracy <math>\pm</math> °C 4 Wire Probe</b> |
|--|
| $\pm 0.011$ at $-100$ °C                         |
| $\pm 0.015$ at $0$ °C                            |
| $\pm 0.019$ at $100$ °C                          |
| $\pm 0.023$ at $200$ °C                          |
| $\pm 0.031$ at $400$ °C                          |
| $\pm 0.039$ at $600$ °C                          |
| <b>Resolution:</b> $0.001$ °C ( $0.001$ °F)      |

**Table 12** Temperature, Thermistor

| <b>Accuracy <math>\pm</math> °C</b>   |
|---|
| $\pm 0.002$ at $0$ °C   |
| $\pm 0.003$ at $25$ °C  |
| $\pm 0.006$ at $50$ °C  |
| $\pm 0.014$ at $75$ °C  |
| $\pm 0.030$ at $100$ °C   |
| <b>Resolution:</b> $0.001$ °C ( $0.001$ °F)   |
| Based on a $10$ k $\Omega$ (at $25$ °C) thermistor with a beta value of $4000$ $\Omega$ . See technical manual for details. |