



1 Carefully unpack box.

2 Make sure you have everything shown here. (Screwdriver not shown)

Keypad Unit Key Carriage Bolt (4x) Hex Nut (4x)

3 Unlock and open front panel of keypad unit; then using carriage bolts and hex nuts, attach unit to pedestal as shown.

What's what?

Important components labeled

Status LED
Provides feedback during operation and programming. See Page 2 for reference.

Keypad
Used for operation and programming

Connection Terminals
For wiring to power and external devices

Reset Button
For performing unit and master reset

Unit shown with front panel fully open. Internal wiring not shown for clarity.

Continued on next page...

! WARNING!

AUTOMATIC GATES CAN CAUSE SERIOUS INJURY OR DEATH!

ALWAYS CHECK that the GATE PATH IS CLEAR BEFORE OPERATING!



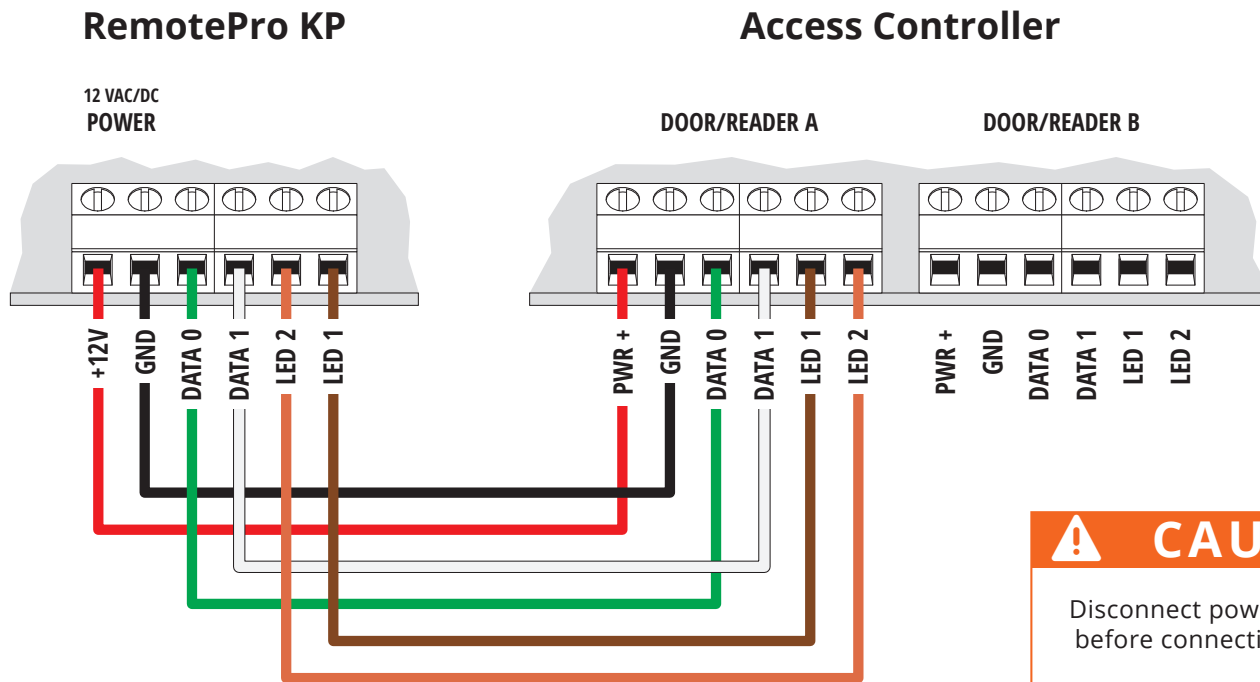

REVERSING or other SAFETY DEVICES SHOULD ALWAYS BE USED!

4 Connect unit.



CAUTION!
 Disconnect power to RemotePro unit before connecting Wiegand devices.
 Failure to disconnect power can damage unit!

Status LED Reference

-  Idle (ready for a command)
-  In Programming Mode
-  1x Code sent to access controller
-  3x Valid code / Programming accepted
-  3x Invalid code / Programming error

5 Set Facility Code.
 (Must be a valid code for the access controller being used. Default is 000.)



NOTE: Green arrow indicates "good" tone on keypad.

6 Set access code length.
 (Access codes may be either 4 or 5 digits in length. Default is 5.)

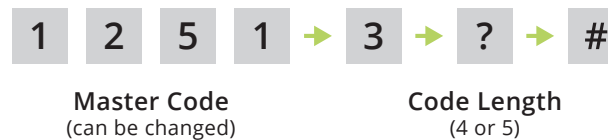

NOTE: Green arrow indicates "good" tone on keypad.



INSTALLATION COMPLETE!

Your system is ready to use.

Additional Programming

A

Change Master Code

(For added security, changing the default Master Code is recommended.)

1 2 5 1 → 2 → ? ? ? ? → #

Current Master Code
(1251 is default)

New Master Code
(4 digits; numbers only)

NOTE: The Master Code is for programming only and will not trigger the relay. The green arrow indicates a "good" tone on the keypad. An incorrect entry will sound a "bad" tone.

B

Unit Reset Procedure

This procedure is used to reset unit to factory default settings.

Step 1 - Open front panel on unit.

Step 2 - Press and hold Reset Button for about 10 seconds.

Unit will sound one (1) tone. Release Reset Button after you hear tone.

Step 3 - Close front panel on unit.

The unit is now reset to factory default settings.

C

Advanced Programming

Toggle LED 2 ON or OFF

(Default is 1 for ON)

1 2 5 1 → 4 → ? → #

Master Code
(can be changed)

LED State
(1 for ON; 2 for OFF)

Toggle Lighted Keypad LEDs ON or OFF

(Default is 1 for ON)

1 2 5 1 → 5 → ? → #

Master Code
(can be changed)

LED State
(1 for ON; 2 for OFF)

NOTE: Green arrow indicates "good" tone on keypad. Always wait for good tone before moving on.

Set Programming Timeout

(Unit will exit Programming Mode if no keys are pressed for period of time set. Default is 10.)

1 2 5 1 → 6 → ? ? → #

Master Code
(can be changed)

Timeout
(03-99; in seconds)

Set Acknowledgment Timeout

(Unit will wait for this period of time to receive response from access controller. If no response is received, unit will sound "error" tone and status LED will flash. Default is 2.)

1 2 5 1 → 7 → ? ? → #

Master Code
(can be changed)

Timeout
(01-99; in seconds)

