



1/3.2" High Sensitivity Miniature Board D/N Camera  
**Watec**  
**WAT-1100MBD**  
**Operation Manual**

This operation manual covers safety, camera functions, installation, and the correct operating procedure for the WAT-1100MBD. First, we ask you to read this operation manual thoroughly, then install and operate the WAT-1100MBD as advised. In addition, for future reference, we also advise safekeeping of this manual.

Please contact the distributor or dealer from which the WAT-1100MBD was purchased, if you do not understand the installation, operation or safety instructions laid out in this manual. Not understanding the contents of the operation manual sufficiently may cause damage to the camera.



### Guide to the Safety Symbols

The definitions of the symbols used in this operation manual are:

-  **Danger** When you do not adhere to or take notice of the "Danger" sign, it may lead to a serious accident such as death or injury caused by fire or electric shock.
-  **Warning** When you do not adhere to or take notice of the "Warning" sign, it may cause severe damage such as a physical injury.
-  **Caution** When you do not adhere to or take notice of the "Caution" sign, it may incur injury and cause damage to peripheral objects in the immediate surroundings.

### Cautions for Safety

The WAT-1100MBD is designed to be used safely; however, it may lead to a physical accident caused by fire and electric shock if not used correctly. Therefore, please keep and read the "Cautions for safety" below for protection against accidents.

-  **Do not disassemble and/or modify the WAT-1100MBD.**  
**Do not operate the WAT-1100MBD with wet hands.**
-  **Use a stabilized power adaptor designed for DC 5V to 12V, with a current capacity of more than 250mA for the WAT-1100MBD.**  
 The recommended voltage is DC 5V to 12V.
- Do not expose the WAT-1100MBD to wetness or high moisture conditions.**  
 The WAT-1100MBD is designed and approved for indoor use only. The WAT-1100MBD is not water-resistant or waterproof. If the location of the camera is outdoors or in an outdoor like environment, we recommend that you use an outdoor camera housing.
- Protect the WAT-1100MBD from condensation.**  
 Keep the WAT-1100MBD dry at all times during storage and operation.
- Should the camera not work properly, switch off the power immediately. Then, check the camera according to the "Problems and Trouble Shooting" section.

-  **Avoid the striking of hard objects or dropping the WAT-1100MBD.**  
 The WAT-1100MBD uses high quality electrical parts and precision components.
- Do not connect any power supply directly to the video out terminal of the unit.**  
 Do not connect the WAT-1100MBD with any monitor using a video/power single transmission terminal. The WAT-1100MBD is not designed for use with this type of equipment. We also advise you to read the operation manual of the monitor you plan to use before any connections are made.
- Do not install the WAT-1100MBD in a position subject to direct sunlight.**  
 Sunlight shining directly onto the WAT-1100MBD lens can cause damage to the image sensor.
- Select a stable place for installation of the WAT-1100MBD.**  
 Always fix the camera securely. See "Mounting Holes" section.
- Do not move the WAT-1100MBD with the cables connected.**  
 Before moving the WAT-1100 MBD, always remove the video cable and power cable from the rear of the camera first.

- Avoid using the WAT-1100MBD near any strong electromagnetic field.**  
 After installing into main equipment, if the WAT-1100MBD is exposed to electromagnetic waves causing the monitored image to become distorted, we recommend the camera be shielded by appropriate protective casing.

### Problems and Trouble Shooting

If any of the following problems occur when using the WAT-1100MBD,

- An optimal picture cannot be obtained, after checking that all the cables and connections are correctly in place.
- Smoke or any unusual odor emerges from the WAT-1100MBD.
- An object becomes embedded or a quantity of liquid seeps into the camera housing.
- More than the recommended voltage or/and amperage has been applied to the WAT-1100MBD by mistake.
- Anything unusual occurring to any equipment connected to the WAT-1100MBD.

**Disconnect the camera immediately according to the following procedures:**

- ① Switch off the main power supply to the camera.
- ② Remove the power and video cables connected to the WAT-1100MBD.
- ③ Contact the distributor or dealer from which the WAT-1100MBD was purchased

### Contents

Using the contents figures below, check to make sure all parts are present before use.

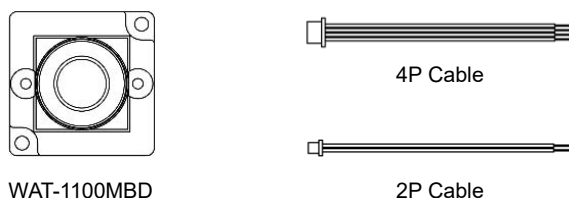

### Description of Parts

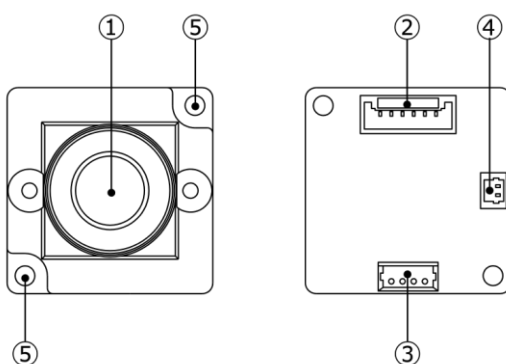

- ① **LENS FRONT FACE**  
 The light receiving face of the Lens (Dirt, water or oil deposits on the lens will cause an unclear picture on the monitor. Attach the lens cap to protect the lens from contamination and damage.)
- ② **OSD (On Screen Display) CONNECTOR**  
 The terminal designed for connection with remote control for setting the functions on the screen.
- ③ **POWER IN / VIDEO OUT**  
 The terminal for power input and video signal output. Use the attached 4P cable for this purpose.
- ④ **POWER SUPPLY CONTROL CONNECTOR for LED**  
 The terminal controls power output (3.3V) for LED in PWM method. Connect the 2p cable for its use. The camera automatically controls the brightness of attached LED.
- ⑤ **MOUNTING HOLES**  
 Four  $\phi$  2.2mm diameter holes in each corner for mounting the camera.

### Power Supply and Wiring

Use a stabilized power adaptor designed for DC+5V to 12V, with a current capacity of more than 250mA

The wiring on the connector must be exact.

Be careful not to touch the other terminal while wiring. Protect the wiring portion by using insulation tape after wiring. If the above care and attention is not adhered to, damage to the WAT-1100MBD and power adaptor may occur or may cause fire.

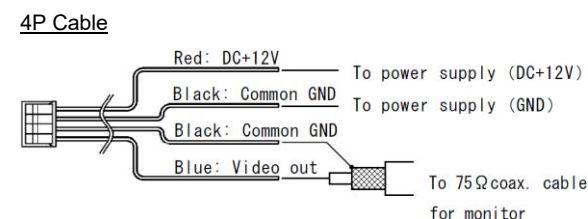

### Mounting Holes

As shown in the figure on the right, the WAT-1100MBD provides two mounting holes, one in each corner of the circuit board. Fix the unit securely using M2 screws. Once the board is secured proceed with the following steps below.

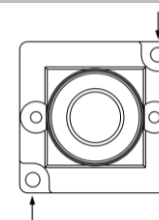

### Set-up and Operation

- 1) Refer to the "Power Supply and the wiring" must be exact.
- 2) Join the video out cable with the video in cable of the monitor or peripheral equipment.
- 3) Join the power supply using the correct procedure.
- 4) Make sure that a picture can be seen on the monitor.
- 5) To focus, turn the lens clockwise or counterclockwise while observing the picture on the monitor. Take care when focusing not to scratch or damage the lens.

### Options

To purchase these options, please contact the distributor or dealer from which you purchased the WAT-1100MBD.



#### Remote Controller (RC-01)

Remote control for controlling the On Screen Display menu to change camera settings.



#### Cable with BNC, socket and connector (CB-01)

The cable with BNC/DC socket. (Cable Length: 1m)

### Specifications

Model	WAT-1100MBD (NTSC)	WAT-1100 MBD (PAL)
Pick-up element	1/3.2 inch BSI CMOS image sensor	
Number of effective pixels	1280(H)×960(V)	1280(H)×924(V)
Unit cell size	3.5um(H)×3.5um(V)	
Synchronizing system	Internal	
Scanning system	Progressive	
Video output	Composite: 1.0 V(p-p) 75Ω (Unbalanced)	
Resolution (H)	More than 750TVL (Center)	
Minimum illumination	0.005 lx. F1.8 (AGC=54dB)	
S/N	More than 55dB (AGC=OFF, $\gamma = 1.0$ )	
Function settings	OSD(On Screen Display) operated by optional remote controller	
AE Mode	EI	1/60~1/100000 sec.
	Fixed	1/60 sec.
White balance	ATW, PUSH, USER1, USER2, MANUAL, PUSH LOCK	
	AGC	0 - 54dB
MGC	MIN, 6, 12, 18, 24, 30, 36, 42, 48, MAX dB	
Day / Night	ICR mechaless Day/Night	
Gamma characteristics	$\gamma \approx 0.45$	
Noise reduction	2DNR ON (Level adjustable)	
Wide dynamic range	Multiple exposure WDR: ON (Level selectable) / OFF	
	ATR: ON (Level selectable) / OFF	
Lens iris	DC	
Back Light Compensation	OFF / BLC / HLC	
Defog	OFF / AUTO (Correction level selectable)	
Privacy mask	16 marks	
Mirror Image	OFF / V-FLIP / H-FLIP / HV-FLIP	
Sharpness	0 - 255 (SHARPNESS)	
Power Supply	DC+5V - 12V	
Power Consumption (12V)	0.72W (60mA)	
Operating Temperature	-10 - 50°C	
Operating Humidity	95% RH or less (Without condensation)	
Storage Temperature	-30 - +70°C	
Storage Humidity	95% RH or less (Without condensation)	
Lens Mount	M12 P=0.5	
Standard lens	M3718BC-12 (f3.7mm F1.8) ※	
Size	23(W)×23(H)×33.5(D) (mm)	
Weight	Approx. 13g	

※ This model is designed to provide stable brightness for the image when the standard lens is used. In case other lenses are applied, this may cause unstable brightness images.

- Design and specifications are subject to change without notice.
- Watec is not responsible for any inconvenience or the attendant damages to the video and monitoring recording equipment caused by misuse, miss-operation or improper wiring of our equipment.
- If for any reason the WAT-1100MBD does not work properly, or if you have any questions regarding installation or operation, please contact the distributor or dealer from which it was purchased.

### Contact information

**Watec** **Watec Co., Ltd.**

Addr.: 254-2 Nihonkoku, Daihoji, Tsuruoka-Shi, Yamagata-Ken, 997-0017 Japan  
 TEL: +81-235-23-4400 FAX: +81-235-23-4409  
 Email: info-o@watec.co.jp  
 URL: http://www.watec.co.jp