

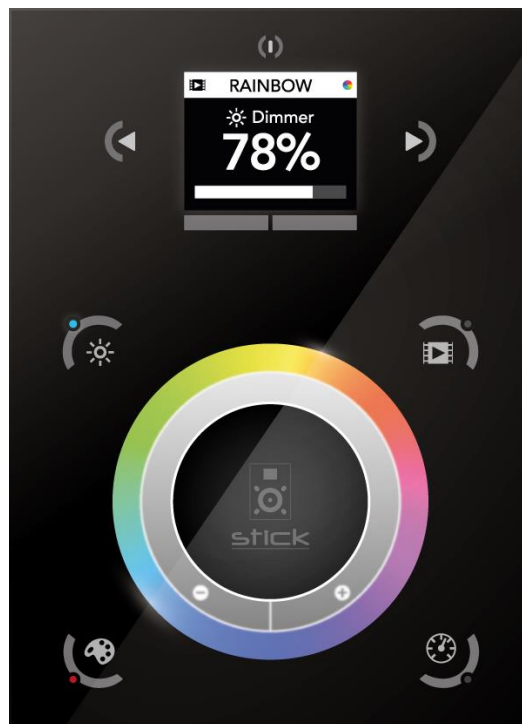

INSTALLATION & OPERATION MANUAL

Wi-Fi DMX TOUCH PANEL CONTROLLER KITS



Preface

READ AND FOLLOW ALL INSTRUCTIONS IN THIS MANUAL

WARNINGS

Before installing your DMX Controller, read and follow all warning notices and instructions which are included. Failure to follow safety warnings and instructions can result in property damage, severe injury or even death.

Before installing your DMX Controller, check local laws for restrictions regarding the use of coloured lights in your area.

Salt is an inherently corrosive material. Natural and man-made surfaces are susceptible to corrosion and deterioration when used in and around salt water. Some combinations of plastic and polymer products are impervious to saltwater corrosion, however, screws and fasteners used for the installation must be of a marine grade type stainless steel or equivalent and monitored annually to ensure the controller remains in service for years to come.

Never Use Solvents! Cleaners, fuel, and other products that may contain strong solvents, such as acetone, that attack many plastics greatly reducing their strength and can cause irreversible damage.

Units are not waterproof. You must mount in a dry location. When installing, be sure that the controller fits the area and secures to the mounting location using the appropriate hardware before installing.

DANGER

RISK OF ELECTRIC SHOCK OR ELECTROCUTION

This unit must be installed by a licensed or certified electrician in accordance with all applicable local codes and ordinances. Improper installation will create an electrical hazard which could result in death or serious injury to installers, or others due to electrical shock, and may also cause damage to property. Always disconnect the power to the light at the circuit breaker before servicing the light. Failure to do so could result in death or serious injury to serviceman, or others due to electrical shock.

Contents

1 Overview.....	3
1.1 TOOLS AND MATERIALS.....	3
1.2 FINDING THE MOUNTING LOCATION.....	3
1.3 SPECIFICATIONS	4
2 Installation.....	5
2.1 CONNECT THE WIRES (EXPLORE E6 & E7).....	5
2.2 CONNECT THE WIRES (PRO SERIES)	5
2.3 MOUNT IN A DRY LOCATION.....	6
2.4 FINALISE YOUR INSTALLATION (EXPLORE E6 & E7)	7
2.5 FINALISE YOUR INSTALLATION (PRO SERIES).....	8
3 Operation.....	9
3.1 POWER / SCENE SELECTION	9
3.2 PRE-PROGRAMMED SCENES – EXPLORE	10
3.3 LOCAL NETWORK CONTROL OVER WI-FI	12
4 Troubleshooting.....	14
5 Warranty	16

PRETEST

Always test the system prior to installation. Failure to do this may result in additional installation time and could invalidate the warranty.

IMPORTANT NOTICE

Attention Installer: This manual contains important information about the installation, operation and safe use of this product. This information should be given to the owner and/ or operator of this equipment.

WARRANTY COVERAGE

Please refer to www.oceanled.com/warranty for full warranty statement.

1 Overview

 **Units are not waterproof. You must mount in a dry location. When installing, be sure that the controller fits the area and secures to the mounting location using the appropriate hardware before installing.**

1.1 TOOLS AND MATERIALS

 **Never use power tools. Hand tighten only!**

- Drill & Drill Bits.
- Screwdriver, Phillips #2
- Wire Strippers.
- Tape measure and Ruler or Straight Edge.
- Marking Utensil (Pencil, Sharpie Magic Marker, etc)

1.2 FINDING THE MOUNTING LOCATION

- The mounting location needs to be carefully selected to ensure the unit will not be exposed to moisture.
- The controller can be installed in any standard electrical backbox. If you use a double size box, you can insert the power supply inside.
- Ensure that the ambient temperature where the unit is mounted cannot exceed 45°C - Note that engine compartments can easily exceed this.
- The chosen location requires access to mains power, space for the routing of the DMX cable to the driver boxes, and also an Ethernet connection to a Wi-Fi router / LAN Wi-Fi for the Wi-Fi controller if the Wi-Fi function is required.

 **We recommend against installing against a metal wall or surface as this can cause issues with the touch buttons.**

 **For DC power installations please contact OceanLED for advice.**

1.3 SPECIFICATIONS

- Ready to use (pre-loaded with scenes).
- Glass Touch Panel with graphical colour display
- USB & Ethernet connectivity for programming and control
- Network communication. Control lighting remotely
- Micro SD Card (32Gb Max)
- 6-7V DC 0.6A / 100-240V AC (With Adapter)
- Environment IP20, Temp -10°C to 45°C
- Certifications: CE, EMC, ROHS, ETL
- Dimensions 146x106x11mm
- Weight 247g

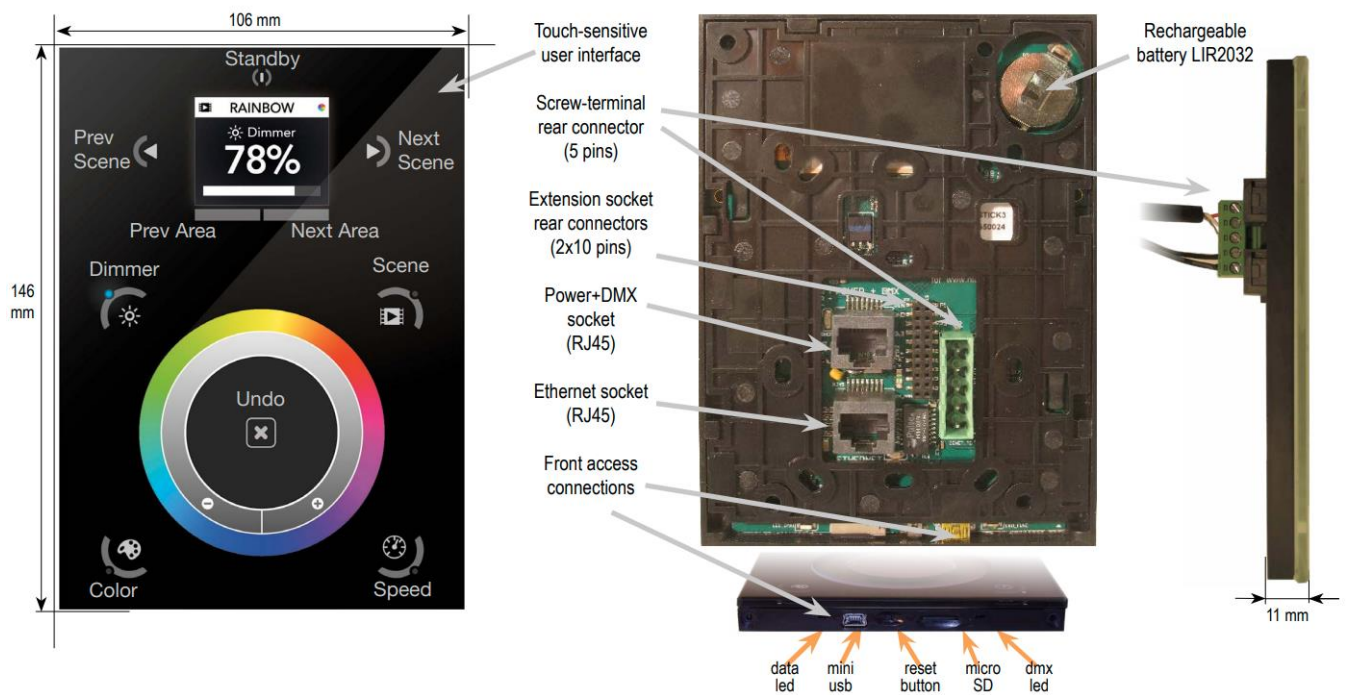

2 Installation

2.1 CONNECT THE WIRES (EXPLORE E6 & E7)

1. Connect the control cable to the green connector (as below)
 - DMX Ground = Black
 - DMX - = Brown
 - DMX + = Yellow
 - Red wire (Unused, do not connect)

2. Connect power via the AC/DC adapter provided.
 - Power DC + = Black/White Stripe
 - Power DC - = Black

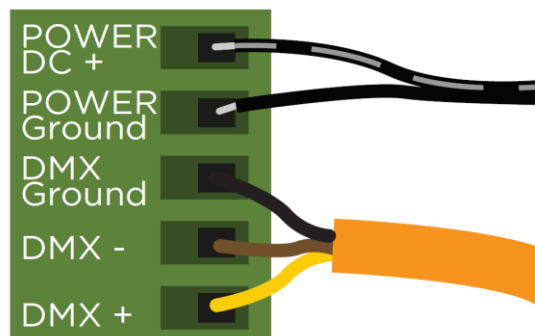

2.2 CONNECT THE WIRES (PRO SERIES)

3. Connect the control cable to the green connector (as below)
 - DMX Ground = Brown & Brown/White (two wires)
 - DMX - = Orange
 - DMX + = Orange/White

4. Connect power via the AC/DC adapter provided.
 - Power DC + = Black/White Stripe
 - Power DC - = Black

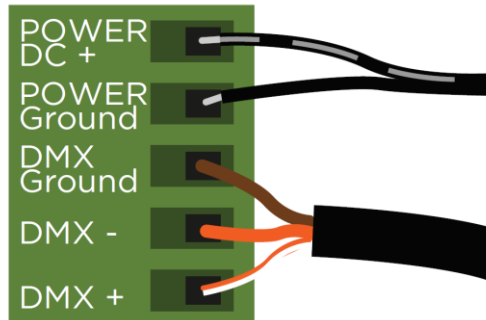

2.3 MOUNT IN A DRY LOCATION



1. Mount the back plate of the interface on the on the preferred dry mounting location with 2 or more screws.
2. Plug the green connector block into the rear of the DMX Wi-Fi Touch Panel Controller.
3. For Wi-Fi plug the local ethernet cable into the rear of the DMX Wi-Fi touch panel controller (Ensure the correct RJ45 port is used):

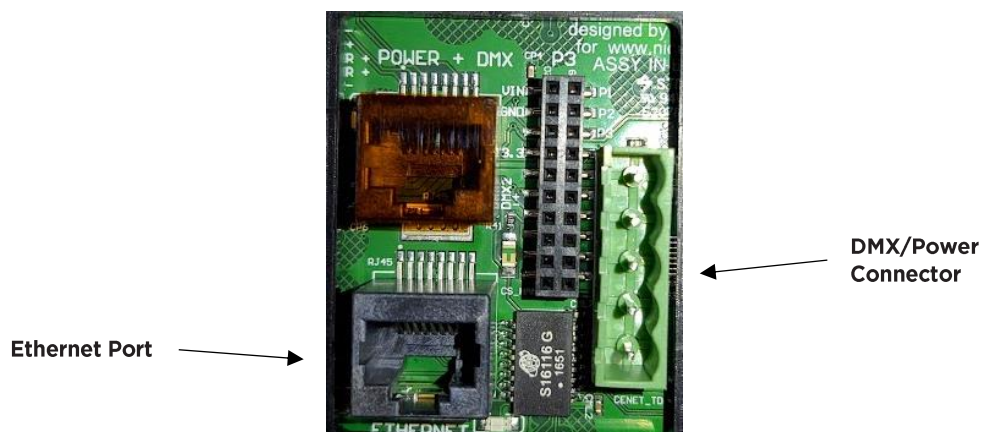

4. The front panel is mounted by pressing it against the back plate and then sliding down. Two screws should then be attached underneath to hold the controller in place. Close the unit by clipping the front panel onto the back plate.

2.4 FINALISE YOUR INSTALLATION (EXPLORE E6 & E7)

Always test the system BEFORE the boat goes back into the water. Typical OceanLED light installs require the boat to be hauled out of the water to replace light units.

The DMX standard recommends a maximum of 32 devices to be connected in one chain. If installation requires more lights than this, please contact OceanLED for advice.

1. If Wi-Fi is required connect Ethernet cable from back of controller panel into a suitable Wi-Fi router or Wi-Fi enabled network. (The controller is DHCP enabled as standard so should be detected by the network once powered).
2. Connect the control cable to the control input of the first Explore E6 light. Then connect a control link cable to the next, and so on up to the last light in the chain.
3. Fit the supplied terminator to the output of the last E6 light. See the following example of the connections:

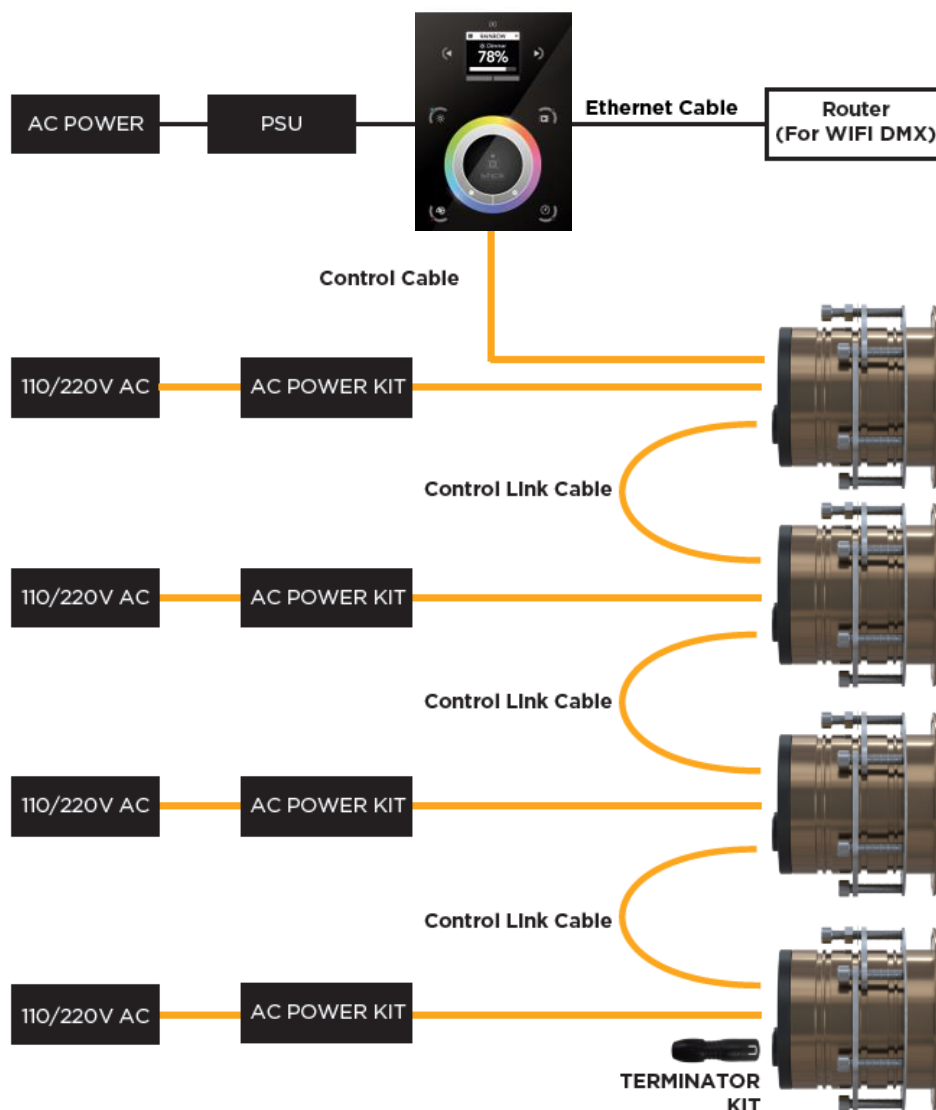

2.5 FINALISE YOUR INSTALLATION (PRO SERIES)

Always test the system **BEFORE** the boat goes back into the water. Typical OceanLED light installs require the boat to be hauled out of the water to replace light units.

The DMX standard recommends a maximum of 32 devices to be connected in one chain. If installation requires more lights than this, please contact OceanLED for advice.

4. If Wi-Fi is required connect Ethernet cable from back of controller panel into a suitable Wi-Fi router or Wi-Fi enabled network. (The controller is DHCP enabled as standard so should be detected by the network once powered).
5. Connect the DMX controller DMX output cable to the DMX input of the first driver box. The DMX output of this box should be connected to the input of the next, and so on up to the last driver in the chain.
6. Fit the supplied terminator to the output of the last driver box. See the following example of the connections:

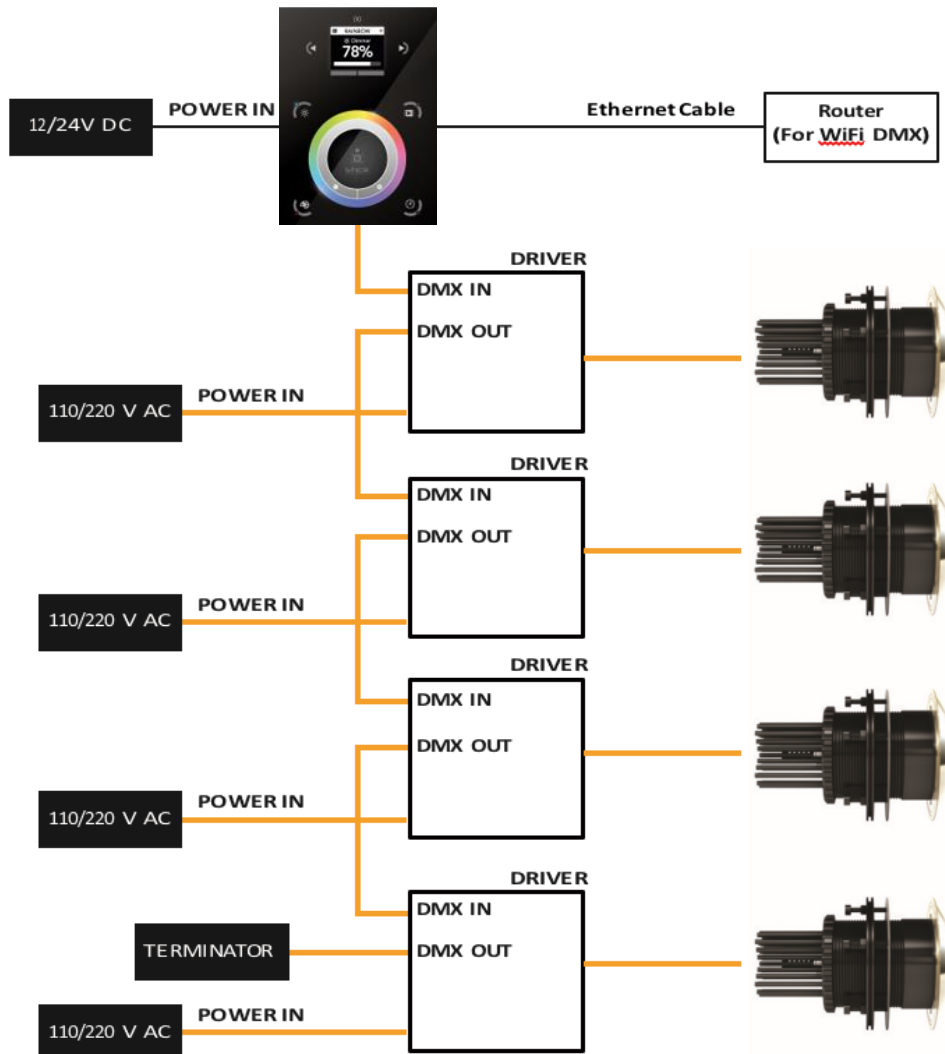

3 Operation

3.1 POWER / SCENE SELECTION

1. Power on the unit by touching the top centre button.
2. Select the required scene by using the buttons under the 'Select Area' buttons below the display to select the required area and select the scene by touching the left / right arrows either side of the display. Once the required scene is selected, play that scene, press the 'Play Scene' button.

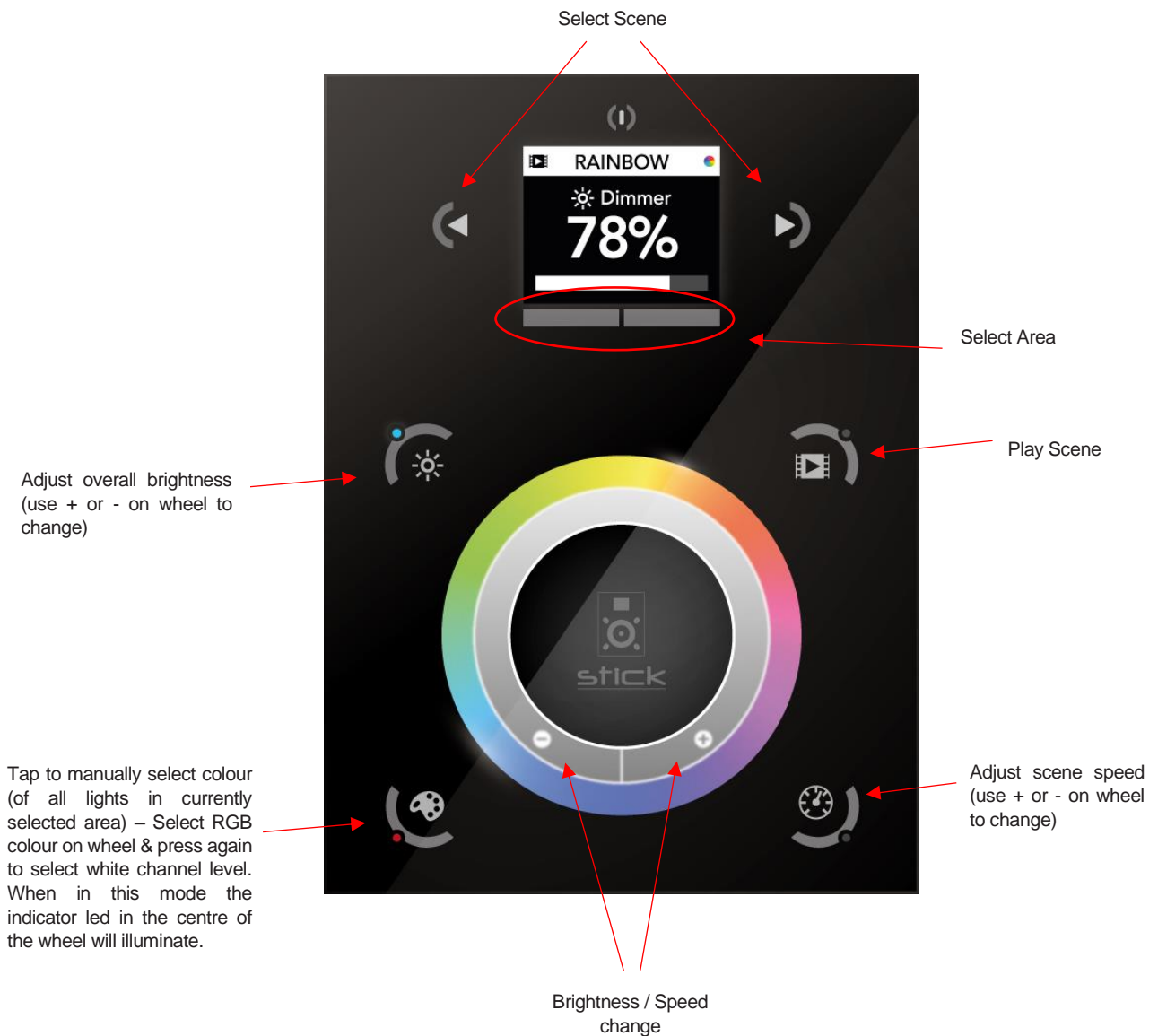

3.2 PRE-PROGRAMMED SCENES – EXPLORE

Explore Dual White / Blue		
Scene	Number	Function
Solid Colours	White	White
	Blue	Blue
	Blue/White	Blue 50% White 50% Mix
Dynamic Modes	White Strb	White Strobe
	Blue Strb	Blue Strobe
	B/W Strb	Blue / White Strobe
	BW Cycle	Blue / White Cycle

Explore / Pro Series Colours		
Scene	Name	Function
Solid Colours	Red	Red
	Orange	Orange
	Yellow	Yellow
	Green	Green
	Blue	Blue
	Indigo	Indigo
	Violet	Violet
	White	White
	Red 2	Red Shade - 2
	Red 3	Red Shade - 3
	Green 2	Green Shade - 2
	Green 3	Green Shade - 3
	Blue 2	Blue Shade - 2
	Blue 3	Blue Shade - 3
	White 2	White Shade - 2
White 3	White Shade - 3	
Dynamic Modes	RGB Cycle	Red Green Blue Cycle
	RGBW Cycle	Red Green Blue White Cycle
	R-B Cycle	Red Blue Cycle
	G-B Cycle	Green Blue Cycle
	B-W Cycle	Blue White Cycle
	G-W Cycle	Green White Cycle
	R-W Cycle	Red White Cycle
	R-G Cycle	Red Green Cycle
	Multi Strobe	Multi Strobe
	RGB Strobe	RGB Strobe – Red Green Blue Strobe
	RGBW Strobe	RGBW Strobe – Red Green Blue White Strobe
	R-B Strobe	Red Blue Strobe
	G-B Strobe	Green Blue Strobe
	R-B-W Strobe	Red Blue White Strobe
	G-W-R Strobe	Green White Red Strobe

3.3 LOCAL NETWORK CONTROL OVER WI-FI

The controller can be connected to a local network, allowing it to be controlled from a smartphone or tablet over Wi-Fi with the use of app called Arcolis Remote available at Google Play and the App store. Arcolis Remote creates an exact replica of the lighting controller on smartphone or tablet, along with a grid of scene buttons.

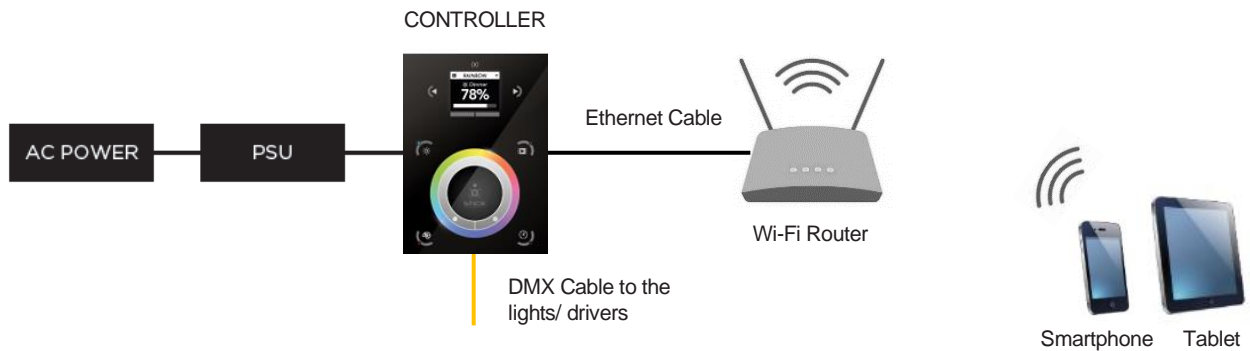

1. Connect the controller to a router or switch with an RJ45 cable:
 - The controller is set by default to get an IP address from the router via DHCP. If the network is not working with DHCP, a manual IP address and subnet mask can be set using the Hardware Manager - please contact OceanLED for more details.
 - If the network has a firewall enabled, allow ports 2430 and 2431
2. Get the IP address of the connected DMX Touch Panel from the router. You can check this by connecting to the router by PC, Mac or via the smartphone.
3. Download the free Arcolis Remote app from the Google Play or App Store depending on the device used.

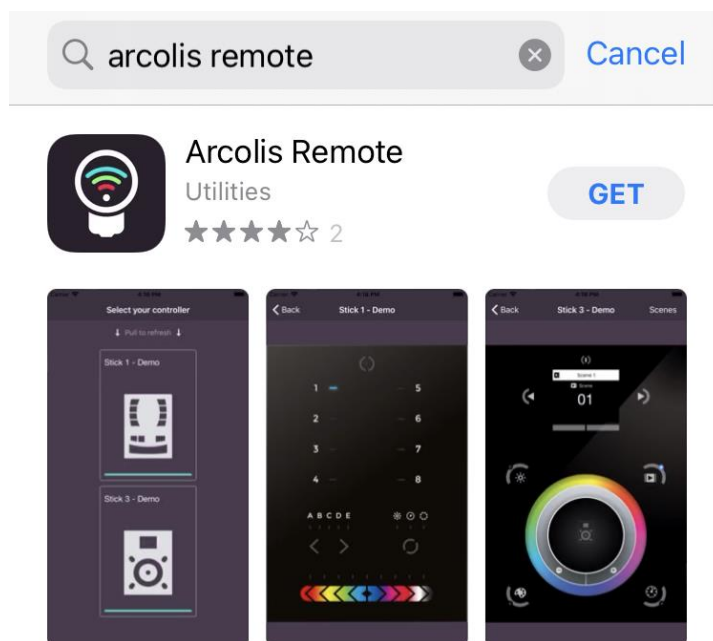

4. Connect your device (smartphone or tablet) to the local Wi-Fi Network.

5. Open the Arcolis Remote app and select the "Add" to enter the DMX Touch Panel IP address.

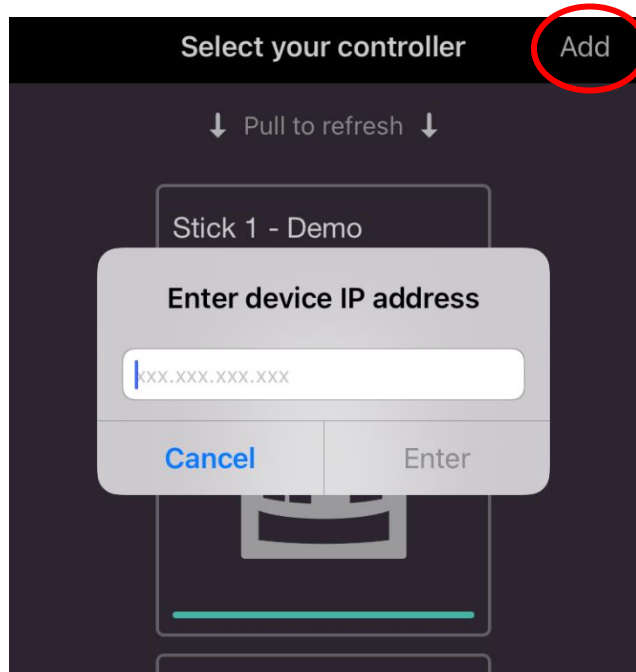

6. Type the IP address and select enter. The app should automatically connect to the device showing the replica of the controller interface on the screen. Use the app to control the lights.



4 Troubleshooting

Wi-Fi DMX Touch Panel Controller			
Problem	Check	Cause	Fix
DMX controller does not power on	Check Power to Controller is on	No Power	Connect Power
		Power OK	Check Connections
	Check Connections to controller faceplate	Connected incorrectly	Correct Connections
		Connected OK	Contact Warranty Department
Lights do not respond to controller and / or random flickering of lights / colours	Check DMX connection is daisy chained between controller and all drivers	Not connected correctly	Correct cabling connections
	Check all other cables are connected correctly and are not damaged	Not connected correctly	Correct connections
		Damaged cable	Replace Cable
	Check Terminator is fitted to last driver box	Terminator not fitted	Fit terminator
		Terminator fitted	Contact Warranty Department
WiFi not working (only applicable to wi-fi model)	Check Ethernet cable is connected into back of controller panel correctly.	Not connected	Reconnect cable
		Controller not visible	Try re-booting network hub and controller panel.
	Check connected network WiFi is functioning correctly	WiFi not functioning	Resolve issue with network WiFi
		WiFi network OK	Contact Warranty Department

Wi-Fi DMX Touch Panel Controller Displayed error messages			
Problem	Check	Cause	Fix
INIT SD	If this message is frozen, it means the controller is having a problem initialising the SD card	Corrupted data on the SD card/ faulty SD card.	Contact Warranty Department
NO SD CARD	No SD card detected	Faulty SD card	Contact Warranty Department
		SD card not fully engaged in the card reader slot/ missing SD card	Re-Install/ Install the SD card
DATA ERROR	The controller can read the SD card; however, it can't understand the data on it.	Corrupted data on the SD card	Contact Warranty Department
EMPTY SD	The SD card is empty.	No data on the SD card.	Contact Warranty Department
CAPSENS	Problem with the touch sensitivity chip detected.	Firmware issue.	Contact Warranty Department

5 Warranty

Please remove this page and keep for your files

For technical assistance:

Europe: service@oceanled.com

The Americas: warranty@oceanledusa.com

Warranty Serial Code(s):

© 2021 Ocean LED Marine LTD
All Rights Reserved

Specifications are subject to change without notice.

Trademarks are the property of Ocean LED Marine LTD

Ocean LED Marine LTD
Unit 1 Jacknell Road
Dodwells Bridge Industrial Estate
Hinckley,
Leicestershire LE10 3BS
United Kingdom

Tel: +44 (0) 1455 637505
Fax: +44 (0) 1455 238553
sales@oceanled.com

Ocean LED USA LLC
778 South Military Trail
Deerfield Beach
Florida
FL 33442-3025
USA

Tel: +1 954.523.2250
Fax: +1 954.523.2249
sales@oceanledusa.com

www.oceanled.com