

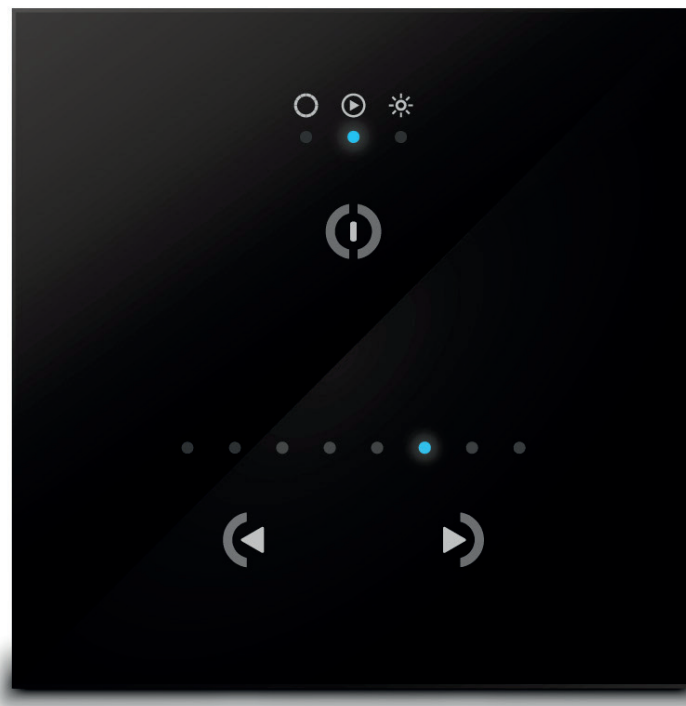

2020  
INSTALL & OPERATION MANUAL

# ***DMX TOUCH PANEL CONTROLLER***

---



# Preface

---

**READ AND FOLLOW ALL INSTRUCTIONS IN THIS MANUAL**



### **WARNINGS**

**Before installing your DMX Controller, read and follow all warning notices and instructions which are included. Failure to follow safety warnings and instructions can result in property damage, severe injury or even death.**

**Before installing your DMX Controller, check local laws for restrictions regarding the use of coloured lights in your area.**

**Do not operate lights out of water for a period longer than 5 minutes followed by an OFF period of at least 1 hour. Exceeding this may cause damage to the light unit.**

**Salt is an inherently corrosive material. Natural and man-made surfaces are susceptible to corrosion and deterioration when used in and around salt water. Some combinations of plastic and polymer products are impervious to salt water corrosion, however, screws and fasteners used for the installation must be of a marine grade type stainless steel or equivalent and monitored annually to ensure the controller remains in service for years to come.**

**Never Use Solvents! Cleaners, fuel, and other products that may contain strong solvents, such as acetone, that attack many plastics greatly reducing their strength and can cause irreversible damage.**



### **DANGER**

#### **RISK OF ELECTRIC SHOCK OR ELECTROCUTION**

**This unit must be installed by a licensed or certified electrician in accordance with all applicable local codes and ordinances. Improper installation will create an electrical hazard which could result in death or serious injury to installers, or others due to electrical shock, and may also cause damage to property. Always disconnect the power to the light at the circuit breaker before servicing the light. Failure to do so could result in death or serious injury to serviceman, or others due to electrical shock.**

# Contents

---

1. OVERVIEW
2. INSTALLATION
3. OPERATION
4. TROUBLESHOOTING

### PRETEST

Always test the system prior to installation. Failure to do this may result in additional installation time and could invalidate the warranty.

### IMPORTANT NOTICE

**Attention Installer:** This manual contains important information about the installation, operation and safe use of this product. This information should be given to the owner and/ or operator of this equipment.

### WARRANTY COVERAGE

2 year warranty from time of purchase, regardless of installation date.  
Please refer to [www.oceanled.com/downloads](http://www.oceanled.com/downloads) for full warranty statement.

# 1 Overview



**Units are not waterproof. You must mount in a dry location. When installing, be sure that the controller fits the area and secures to the mounting location using the appropriate hardware before installing.**

### 1.1 TOOLS AND MATERIALS



**Never use power tools. Hand tighten only!**

- Drill & Drill Bits.
- Screw Driver, Phillips #2
- Wire Strippers.
- Tape measure and Ruler or Straight Edge.
- Marking Utensil (Pencil, Sharpie Magic Marker, etc)

### 1.2 FINDING THE MOUNTING LOCATION

- Ensure that the ambient temperature where the unit is mounted cannot exceed 45 degrees C - Note that engine rooms can easily exceed this.
- The chosen location requires access to mains power and space for the routing of the DMX cable.



**For DC power installations please contact OceanLED for advice**

### 1.3 SPECIFICATIONS

- Ready to use (pre-loaded with dynamic / static scenes).
- 3 touch sensitive buttons (on/off/mode, previous, next)
- 32-bit ARM technology
- 5 - 12V DC / 100-240V AC (With Adapter)
- Environment IP20, Temp 0°C to 50°C
- Certifications: EC, EMC, ROHS, ETL, UL (some in progress)

# 2 Installation

## 2.1 CONNECT THE WIRES (EXPLORE SERIES)

1. Connect the control cable to the green connector (as below)
  - DMX Ground = Black
  - DMX - = Brown
  - DMX + = Yellow
  - Red wire (Unused, do not connect)
2. Connect power via the AC/DC adapter provided.
  - Power DC + = Black/White Stripe
  - Power DC - = Black

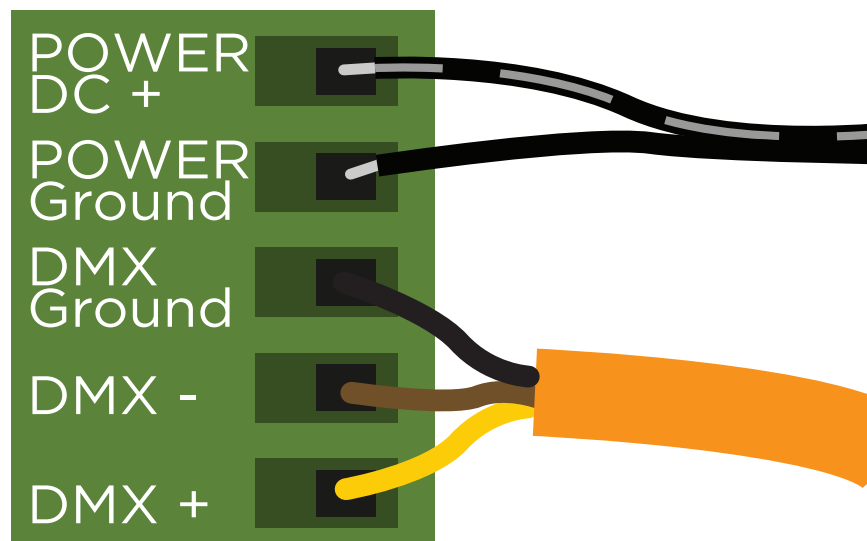

## 2.2 CONNECT THE WIRES (PRO SERIES)

1. Connect the DMX cable to the green connector (as below)
  - DMX Ground = Brown+Brown/White
  - DMX - = Orange
  - DMX + = Orange/White
2. Connect power via the AC/DC adapter provided.
  - Power DC + = Black/White Stripe
  - Power DC - = Black

# Installation

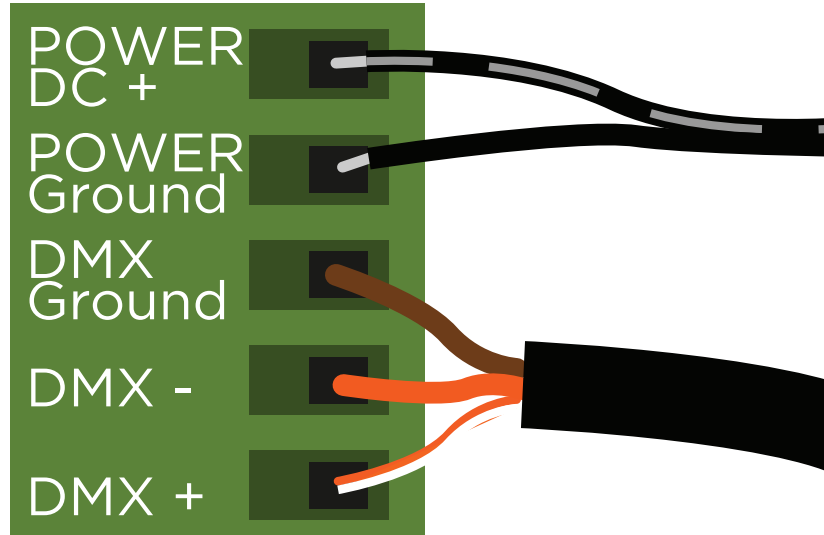

### 2.3 MOUNT IN A DRY LOCATION

1. Plug the green connector block into the rear of the DMX Touch Panel Controller.

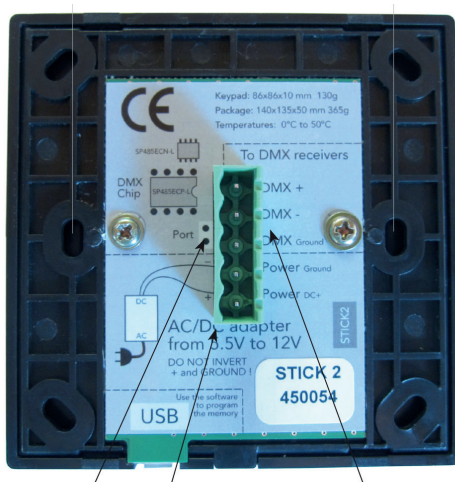

2. Mount the back plate of the interface on the preferred mounting location. (in a dry place) 86mm X 86mm X 10mm
3. Close the unit by clipping the front panel onto the back plate.

# Installation

## 2.4 FINALISE YOUR INSTALLATION (EXPLORE SERIES)



Always test the system **BEFORE** the boat goes back into the water. Typical OceanLED light installs require the boat to be hauled out of the water to replace light units.

The DMX standard recommends a maximum of 32 devices to be connected in one chain. If installation requires more lights than this, please contact OceanLED for advice.

1. Plug the Terminator to the Control Out of the last light.

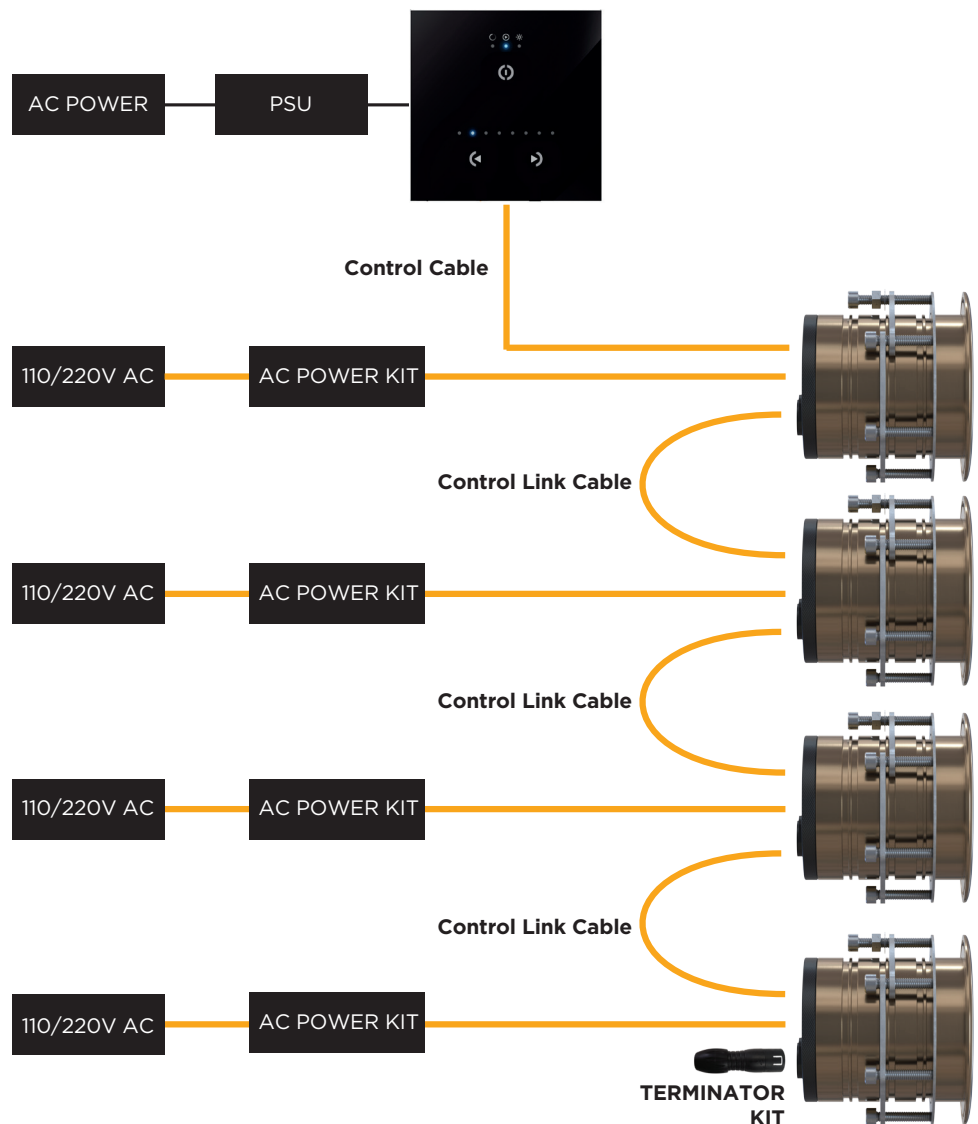

# Installation

### 2.5 FINALISE YOUR INSTALLATION (PRO SERIES)



**Always test the system BEFORE the boat goes back into the water. Typical OceanLED light installs require the boat to be hauled out of the water to replace light units.**

**The DMX standard recommends a maximum of 32 devices to be connected in one chain. If installation requires more lights than this, please contact OceanLED for advice.**

1. Connect the DMX controller DMX output cable to the DMX input of the first driver box. The DMX output of this box should be connected to the input of the next, and so on up to the last driver in the chain.
2. Fit the supplied terminator to the output of the last driver box

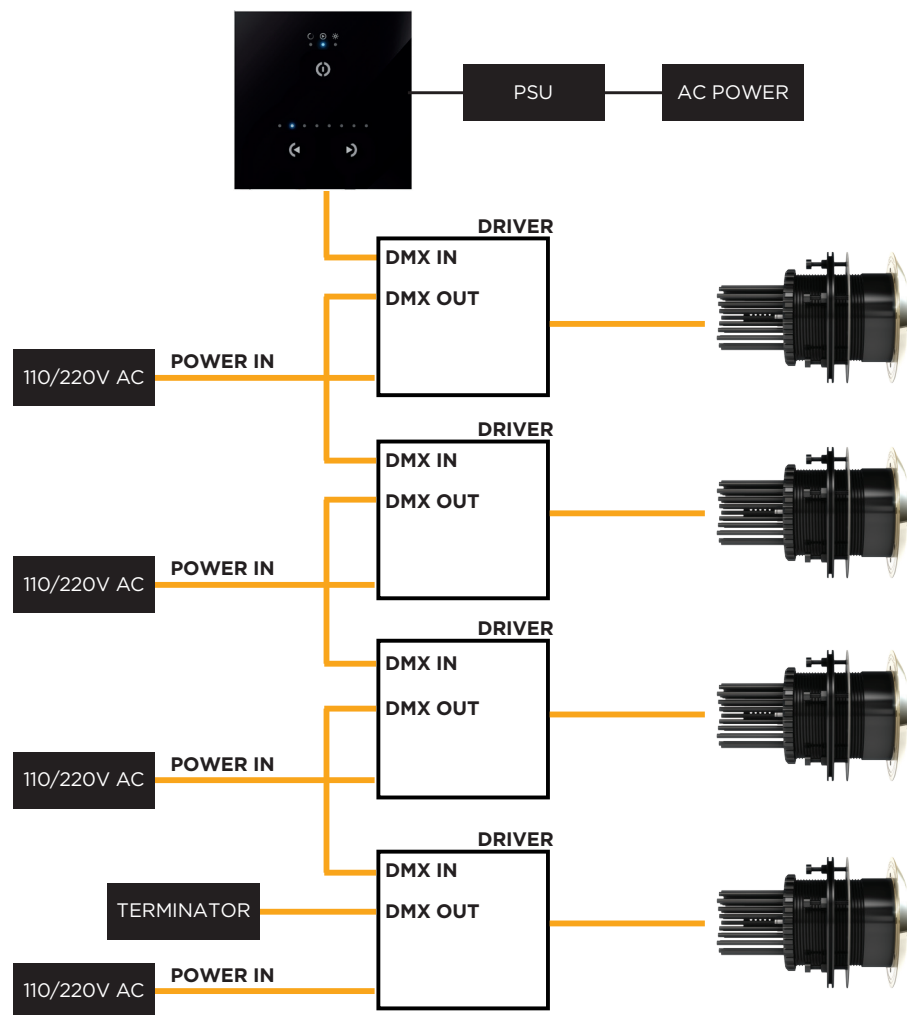



# 3 Operation

## 3.1 POWER / SCENE SELECTION

1. Power on the unit by touching the top centre button.
2. Select the required scene by touching the left / right arrows . The blue led displays the selected scene

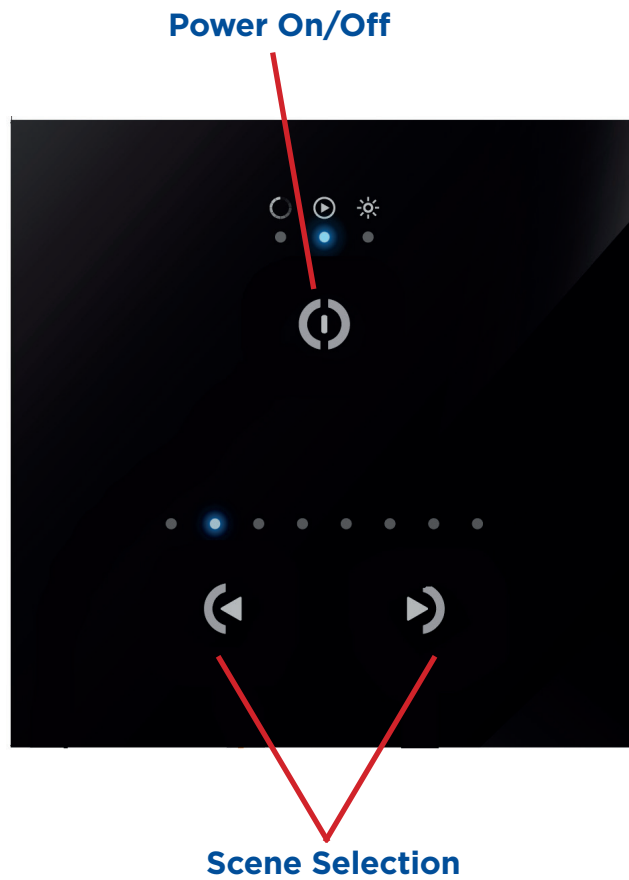

# Operation

### 3.2 PRE PROGRAMMED SCENES

Explore E6 Colours	
Scene	Function
1	Red
2	Green
3	Blue
4	Super White
5	Colour Cycle

Explore E6 Dual White / Blue	
Scene	Function
1	White
2	Blue
3	Blue-White
4	Blue-White Fade
5	Blue

Pro Series Colours	
Scene	Function
1	Red
2	Green
3	Blue
4	Super White
5	Colour Cycle

# 4 Troubleshooting

DMX Touch Panel Controller			
Problem	Check	Cause	Fix
DMX controller does not power on	Check Power to Controller is on	No Power	Connect Power
		Power OK	Check Connections
	Check Connections to controller faceplate	Connected incorrectly	Correct Connections
		Connected OK	Contact Warranty Department
Lights do not respond to controller and / or random flickering of lights / colours	Check DMX connection is daisy-chained between controller and all drivers	Not connected correctly	Correct cabling connections
	Check all other cables are connected correctly and are not damaged	Not connected correctly	Correct connections
		Damaged cable	Replace Cable
	Check Terminator is fitted to last driver box	Terminator not fitted	Fit terminator
		Terminator fitted	Contact Warranty Department

# Warranty

**Please remove this page and keep for your files**

**For technical assistance:**

**Europe: [service@oceanled.com](mailto:service@oceanled.com)**

**The Americas: [warranty@oceanledusa.com](mailto:warranty@oceanledusa.com)**

**Warranty Serial Code(s):**

**© 2020 Ocean LED Marine LTD  
All Rights Reserved**

Specifications are subject to change without notice.

Trademarks are the property of Ocean LED Marine LTD



**Ocean LED Marine LTD**

Unit 1 Jacknell Road  
Dodwells Bridge Industrial Estate  
Hinckley,  
Leicestershire LE10 3BS  
United Kingdom

Tel: +44 (0) 1455 637505  
Fax: +44 (0) 1455 238553  
[sales@oceanled.com](mailto:sales@oceanled.com)

**Ocean LED USA LLC**

778 South Military Trail  
Deerfield Beach  
Florida  
FL 33442-3025  
USA

Tel: +1 954.523.2250  
Fax: +1 954.523.2249  
[sales@oceanledusa.com](mailto:sales@oceanledusa.com)

[www.oceanled.com](http://www.oceanled.com)