

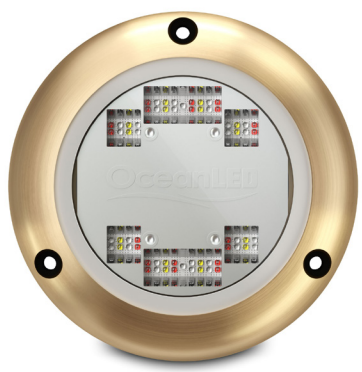

OceanLED Support
INSTALL MANUAL

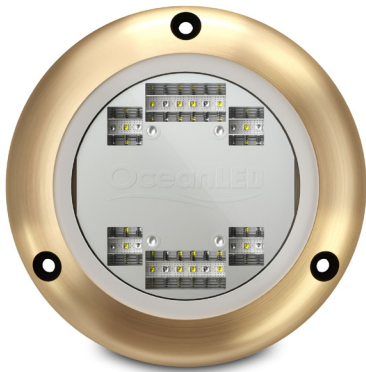
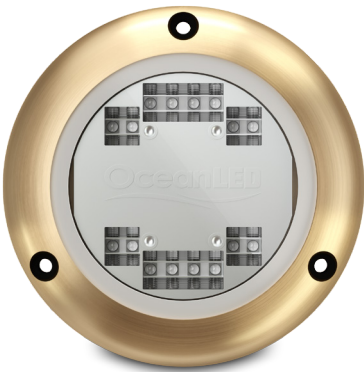

Sport Series		
S3116s Single Colour	S3124s Dual Colour	S3166s Multi Colour
Product kit includes: Light / Screws / Fuse Kit		

OceanLED reserve the right to change this document without notice. Please refer to www.oceanled.com for latest documentation.



IMPORTANT: Please read the instructions completely before proceeding with the installation. These instructions supersede any other pre dated instructions if they differ.

Chapter 1	4
An overview of the underwater light installation. It includes sections on unpacking and inspecting the components, selecting the mounting site and a description of how best to make the cable runs.	
Chapter 2	6
Detailed instructions on how to mount and connect each type of light.	
Chapter 3	10
Operating the light	
Chapter 4	12
Maintenance and troubleshooting tips.	
Chapter 5	14
Appendix	
Chapter 6	15
Warranty statement.	

PRETEST

Always test the lights prior to installation. Failure to do this may result in additional installation time. OceanLED cannot be held responsible for any consequential costs incurred after installation.

GENERAL

OceanLED underwater lights are generally used for illuminating the water around a boat or yacht. Best placement for achieving the best results are described in "1.5 Finding the mounting location".

WARRANTY COVERAGE

2 year warranty from time of purchase, regardless of installation date.

WARNING!

Never use solvents! Cleaners, fuel, paint, sealants, and other products that may contain strong solvents, such as acetone, that attack many plastics greatly reducing their strength and irreversibly damaging the special Tritonium coating and cable sheathings.

WARNING!

Light is for mounting directly to a flat surface, with the cable passing through a 1/2" (12.5mm) hole. Do not submerge your cable ends in water; cable and connections exposed to underwater submersion will not be covered by warranty. Mounting the light in any other configuration, other than those described in this guide, will invalidate its warranty.

IMPORTANT PRECAUTIONS!

ATTENTION INSTALLER: This manual contains important information about the installation, operation and safe use of this product. This information should be given to the owner and/ or operator of this equipment.

 **CAUTION:** (Risk Group 2): Possibly hazardous optical radiation emitted from this product. Do not stare at operating lamp. May be harmful to the eye.

 **CLASS 3:** This equipment is designed to operate at voltages of less than 50v DC.

WARNING

- Before installing your OceanLED Light, read and follow all warning notices and instructions which are included. Failure to follow safety warnings and instructions can result in property damage, severe injury or even death.
- Before installing your OceanLED Light, check local laws for restrictions regarding the use of colored lights in your area.
- It is advised not to operate lights out of water for a period longer than 5 minutes. Exceeding this may cause damage to the light unit
- Salt is an inherently corrosive material. Metal parts and certain natural and man-made surfaces are particularly susceptible to corrosion and deterioration when used in and around salt water. Some OceanLED lights contain combinations of plastic and polymer products which are impervious to salt water corrosion, however, screws and fasteners used for the installation must be of a marine grade type stainless steel or equivalent and monitored annually to ensure the lights remain in service for years to come.
- Never Use Solvents! Cleaners, fuel, and other products that may contain strong solvents, such as acetone, that attack many plastics greatly reducing their strength and irreversibly damaging the special lens coatings and cable sheathings

DANGER! Risk of Electrical Shock or Electrocution!

 This underwater light must be installed by a licensed or certified electrician in accordance with all applicable local codes and ordinances. Improper installation will create an electrical hazard which could result in death or serious injury to swimmers, installers, or others due to electrical shock, and may also cause damage to property. Always disconnect the power to the light at the circuit breaker before servicing the light. Failure to do so could result in death or serious injury to serviceman, swimmers or others due to electrical shock.

READ AND FOLLOW ALL INSTRUCTIONS IN THIS MANUAL.



Chapter 1: Overview

This handbook provides instructions to assist you in the installation and set up of the Sport Series lights from OceanLED.

1.1 Identifying your model

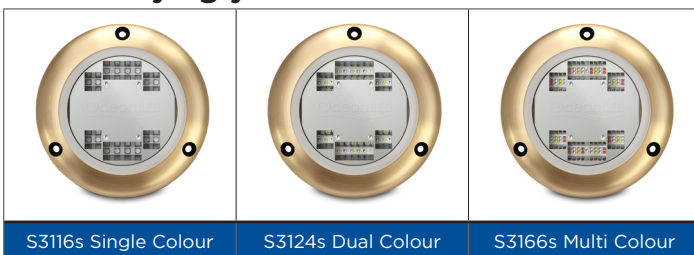

S3116s Single Colour

S3124s Dual Colour

S3166s Multi Colour

1.2 DC power / fuse ratings

The majority of installations will utilize onboard 12/24v DC power supply from a marine battery. However, if AC to DC power supply is being used, allow at least 15% reserve for voltage fluctuations due to variables beyond your control such as ambient temperature and supply voltage fluctuations to ensure your lights are always receiving the proper voltage and to ensure the power supply is not “overworked” causing premature failure. Use chart below in determining power supplies.

Model	Current @ 12v DC	Current @ 24v DC	Power consumption in Watts	15% reserve in Watts	Recommended fuse 12v/24v DC
S3116s	5.5A	2.3A	66	76w	7A
S3124s	3.6A	1.7A	43	50w	7A
S3166s	5.5A	2.3A	66	76w	7A

1.3 Tools and materials

- Drill
- Pozi head screwdriver
- Marine sealant - 3M 4200 or equivalent
- Zip-ties
- Waterproof cable connectors / butt splices and gluelined heat shrink and/or IP68 junction box(s)
- Mounting template
- Sandpaper

1.4 Optional extras

JUNCTION BOX -

- For a more professional watertight connection for your Sport lights, use the fused junction box to connect up to 4 lights in an IP66 enclosure.

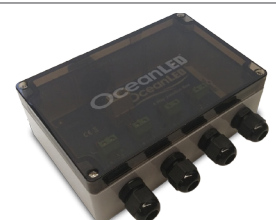

WARNING: ENSURE MOUNTING LOCATION IS FLAT AND CHECK INTERNALLY FOR EASE OF ACCESS IF THERE IS A RIB, STRUT OR OTHER HULL THAT MAY INTERFERE WITH THE INSTALLATION. AVOID MOUNTING LIGHTS ON SURFACES THAT ARE SUBJECTED TO HIGH SPEED WATER IMPACT E.G. PLANING SURFACES.

1.5 Finding the mounting location - UNDERWATER

Considerations

NOTE: To ensure correct dispersion of light underwater, ensure all Sport Lights are mounted with the correct orientation with logo facing upwards.

- Sport lights are suitable for GRP and wooden hulls.
- Ideal mounting depth is 10 – 20 cm / 4 - 8".
- Ideally mount your Sport Series lights at similar depth levels when using underwater to ensure matching colour consistency through the water. Deeper lights will look duller and possibly differ in colour to shallower mounted units.

Spacing -

- If positioning lights on a transom, take into consideration swim platforms and obstacles that may block the initial portion of the light.

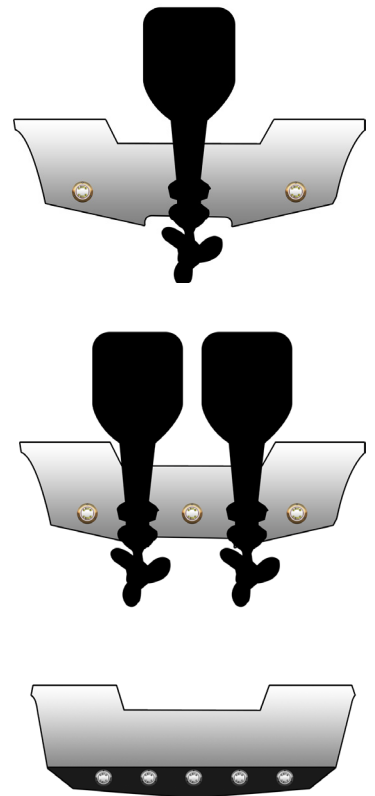



Chapter 2: Installation



Note: OceanLED makes every effort to protect our marine and fresh water environment as well as our natural resources. Please take care to keep packaging away from and out of the water by ensuring loose packaging materials are secured and not susceptible to being blown into the water. Please recycle all packaging materials as the sustainability of our environment is everyone's responsibility.

WARNINGS:

- Never use power tools to secure your lights; **hand tighten only.**
- We recommend you use screws provided. If alternative screws are used, do not use counter sunk or non flat shoulder screws to secure your lights to the hull.
- OceanLED recommends dry fitting all products. When installing, be sure that the light fits the area and secures to the hull using the appropriate hardware before applying any sealant.
- Light is for thru-hull mounting only. Cable and connections exposed to underwater submersion will not be covered by warranty!
- There are several different hull types. Most are either solid GRP or cored. Be sure you follow the correct procedures for the hull you are preparing since all require different preparation methods. We will cover the most common type below. If in doubt please contact your local OceanLED representative or the boat manufacturer for assistance.
- Please check all components prior to installation. If there is any damage to connectors, cables, and/or any other component, please notify OceanLED BEFORE installation. Failure to notify OceanLED of damage in transit prior to installation will lead to violation of warranty.
- **Light is for mounting directly to a flat surface on the hull, with the cable passing through a 1/2" (12.5mm) hole in the hull.** Do not submerge your cable in water; cable and connections exposed to underwater submersion will not be covered by warranty. Mounting the light in any other configuration, other than those described in this guide, will invalidate its warranty.

2.1 Preparing a fiberglass hull

TIP: Always wear safety goggles and a dust mask.

1. Drill a 3mm / 1/8" pilot hole square to mounting surface from inside the hull if possible. If there is a rib, strut, or other hull irregularity near the selected mounting location, this will need to be taken into account in the planning phase and the location adjusted accordingly, or the obstruction safely removed or modified.
2. Using a suitable drill, make a 1/2" (12.5mm) hole. Ensure the light will fit flush and will be square to the mounting surface.
3. Sand the area around the hole using a heavy grit sandpaper to remove the previous bottom paint and to ensure that the sealant will adhere properly to the hull. If there is any petroleum residue

inside the hull, remove it with acetone before sanding.

4. Place light fixture into position or use mounting template provided. Mark the screw hole position and pilot drill using correct sized drill bit for included screws.
5. Always dry fit units before applying any sealant.

2.2 Installing the light fixture

TIP: Use a suitable marine sealant such as 3M™ Marine Adhesive Sealant Fast Cure 4200FS. When applying sealant to light fixture, be careful to protect the lens from any abrasive surface/floor so as not to remove the protective Tritonium coating.

1. Once hull preparation is complete, the light can be inserted into the hole previously prepared. Apply generous amounts of the sealant you are using to the back perimeter of the light body. Make sure to generously coat the cable of the light where it meets the back of the light. There should be an unbroken bead of sealant around the perimeter of the light unit, screw holes and cable exit.

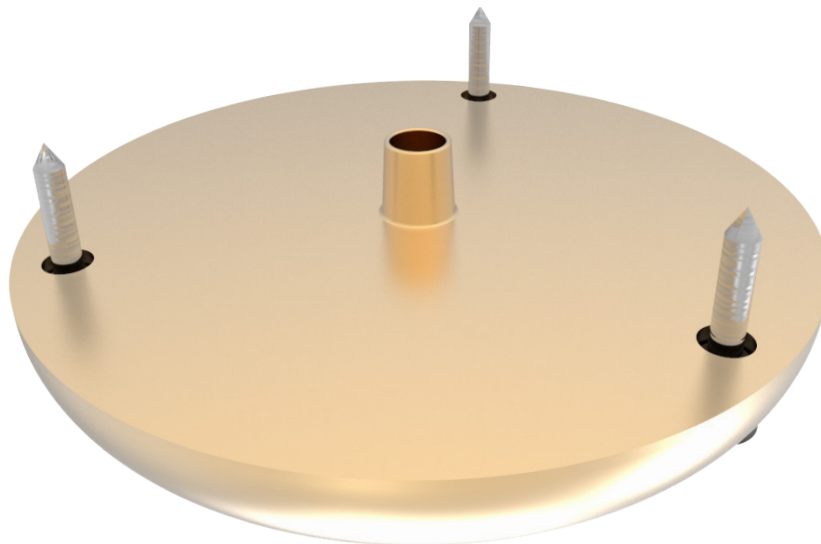

3. Position the light on to the hull, feeding the cable through first and seat into place. Press the light hard onto the hull to ensure good adhesion.
4. To ensure correct dispersion of light underwater, ensure all Sport Lights are mounted with the correct orientation with logo facing upwards.



WARNING: Tighten the screws with a hand tool ONLY!



5. Once you are satisfied that the unit is fully adhered onto the hull, you will notice that sealant has squeezed out from around the perimeter of the light. Using a cloth wipe off excess sealant to leave a clean seal. If you do not see sealant squeeze out from the body, you have not used enough sealant or tightened the unit enough to the hull. Carefully examine the installation to make sure the seal you have installed on the unit is fully water-tight. If in doubt, remove light, re-apply sealant and re-install.

2.3 - Connecting the light fixture

WARNING:

- Always consult a qualified electrician when connecting OceanLED light fixtures.
- When connecting light units, please note that all OceanLED lights will operate within a specific voltage range.

Connecting lights to your DC power source

OceanLED Sport models require a 12/24v DC supply. This supply should be a minimal 6A @ 12vDC or 3A @ 24v DC per light. It is recommended to connect the light to the DC power source using a two pole, screw type terminal block with a minimum voltage rating of 50V and a current rating of at least 6A. The ends of the cable should be stripped back (if required) and suitable ferrules fitted. The terminal block should be fixed inside a waterproof enclosure (IP66 minimum).

TIP: Switch and breaker need to be robust enough to support light.

TIP: For complete instructions on DC connections, please refer to ABYC codes of practice and other applicable codes and ordinances for DC connections.

WARNING: Never leave the bare cables unprotected. Take care to not leave the bare wire ends in bilge water before making the waterproof connections. Water deposits in the connectors and cables will cause corrosion. Over time water can also work its way into the unit along the inside of the cable due to capillary action causing the light to fail. This will NOT be covered under warranty.

1. Depending on the model and number of lights installed you will need to pull the correct sized power cable from the breaker/fuse panel to the light locations to supply constant power to the units. It is imperative that the correct sized tinned boat cable is used to avoid voltage drop issues. See appendix for recommended cable gauges.
2. Using waterproof butt splices or IP66 waterproof junction boxes, make the connections at either end of the system to attach the lights to the DC system. If appropriate, use a dielectric grease when making the connections and make sure any heat shrink used completely encapsulates the outer wire sheath (the use of glue-lined heat shrink is highly recommended to ensure water tightness).

NOTE: Corrosion of wire, and/or water ingress into the light unit via the cable is NOT covered under warranty.

3. If you are not installing a custom fuse panel, it is imperative that the OceanLED supplied fuse is installed on each power line from each light. See table in chapter 1.
4. Secure cables ensuring where the cable exits the light it is not under undue stress. Finish and test light units BEFORE the boat goes into the water. If you have any issues and need troubleshooting advice, please contact your local OceanLED representative.

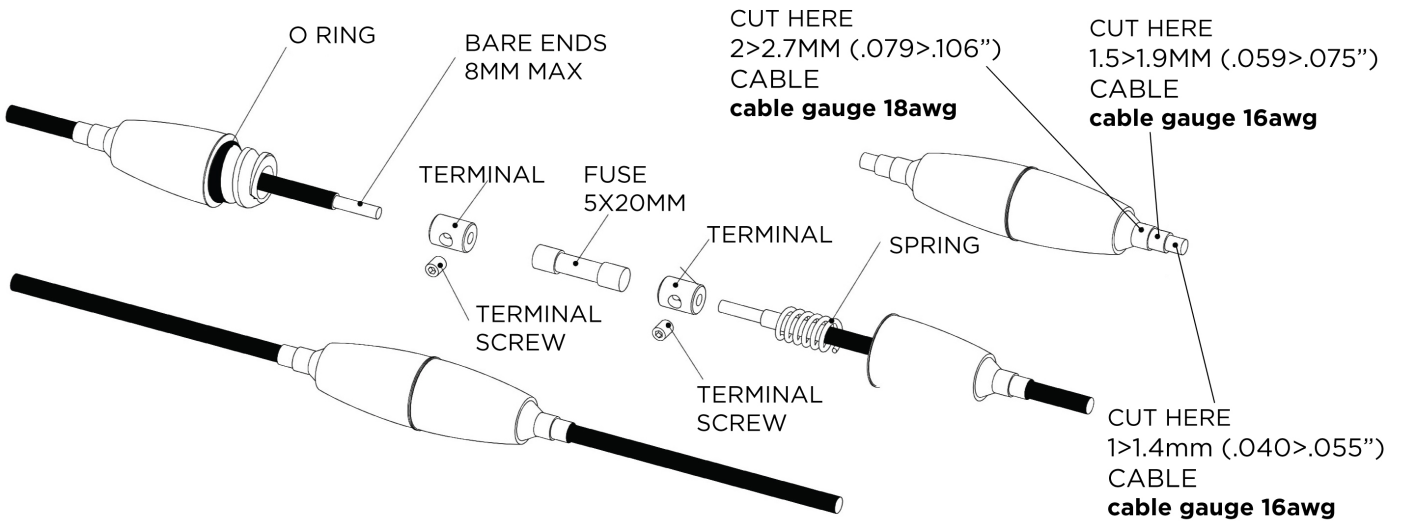

Sport Multi Colour Wiring Diagram

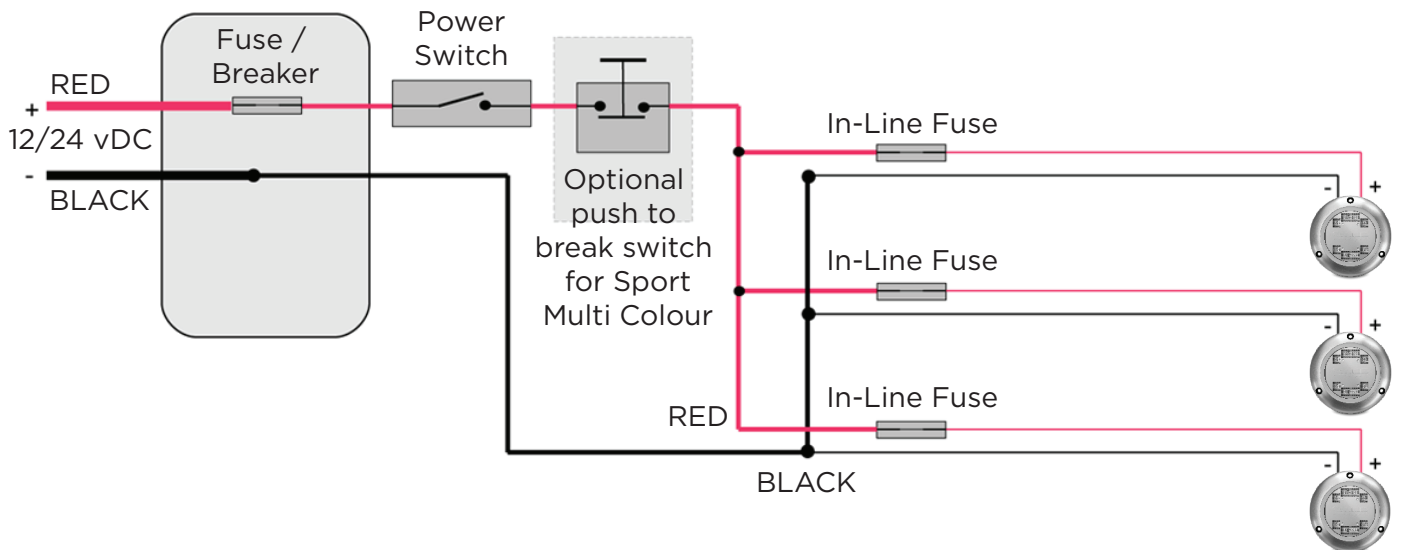

2.4 - Finalize your OceanLED installation

Test your lights

Always test the lights BEFORE the boat goes back into the water. Failure to test prior to launch may require boat to be re-hauled out. At this final stage make sure all of the system is operational. See Chapter 3 Operation. If you have any issues, please contact your local OceanLED representative.

Warning: Never install a new light and leave the boat in the water unchecked for several days.

When the boat is placed in the water, immediately check for leaks. Note that very small leaks may not be readily observed. It is best not to leave the boat in the water for more than 3 hours before checking it again. If there is a small leak, there may be considerable bilge water accumulation after 24 hours. If a leak is observed you must take action immediately to prevent damage to the property.



Chapter 3: Operation

3.1 - Single Colour Strobe

To enter strobe mode, toggle the power on and off quickly twice, then back on. They should now strobe in a pseudo-random pattern. The lights can be reset from strobe mode after 20 seconds of use. Simply turn off then back on again.

3.2 - Dual Colour Operation

The Dual colour change has seven modes of operation;

1. Single colour white – this mode is entered when the light is first turned on.
2. Single colour blue
3. Fade - Fade between white and blue.
4. Random white strobe -
5. Random blue strobe -
6. Alternate blue/white strobe
7. Dual colour (blue and white both on)

To cycle between the above modes, turn off the light for less than 1 second, then back on again.

PLEASE NOTE: Fade mode is not guaranteed to stay in sync between lights over time.

3.3 - Sport Dual Colour Configuration Mode

Description: Enables selection of either white or blue colour as default at power up.

To enter configuration mode:

1. Turn on light(s)
2. Wait around 1 second (or until light(s) illuminate)
3. Turn off light(s)
4. Wait for a minimum of 5 seconds then turn light(s) back on again.
5. Repeat steps 2-4 another 4 times. (If the light changes mode on re power up then the light has not been turned off for long enough in step 4)
6. On the 5th power up, the light(s) should enter the configuration mode – this will be confirmed with a sequence of five blue/white flashes followed by a steady white (the steady colour indicates the default start up colour).

Setting the default start up colour:

1. Once the configuration mode has been entered (see above). Toggling off the power and back on again quickly (as in a normal mode change) will toggle between the default start-up colours (blue & white). This is indicated by the colour displayed after the blue/white flash sequence.
2. To save the selected state simply turn off the light(s) when the required start up colour is displayed and wait for 5-10 seconds.
3. The light(s) should now be configured to start with the selected colour as default.

3.4 Sport Multi Colour control with DC switch operation:

The Sport Multi Colour has three modes of operation, single colour mode, cycle / programming mode, and strobe mode:

1. Single colour mode - this mode is entered when the light is first turned on. The light will be a single colour, either a default white, or a previously selected colour.
2. Strobe mode - to enter this mode, turn off the light for less than 1 second, then back on again. The light will flash in a pseudo-random pattern - the colour will be the same as that in single colour mode.
3. Cycle / Program mode, to enter this toggle the power to the unit off twice for less than 1 second each time. The light will then slowly cycle and fade through the colour spectrum (see diagram below for cycle order). It can be left in cycling if required, or alternatively, once the light shows the desired colour this can be stored by switching the light off for more than 2 seconds. When the light is switched back on it will be back in single colour mode, displaying the previously selected colour.

NOTE: If during the above operations, one or more lights connected go out of sync, simply switch off the lights for more than 2 seconds, then re-enter cycle mode to re-select the colour.

3.5 Sport Multi Colour cycle:

Blue ----> White ----> Green ----> Blue ----> Red ----> Green (then repeat).



Chapter 4: Maintenance and troubleshooting

4.1 - Cleaning Instructions

Sea growth can collect quickly on the light and this can reduce the performance in just a few weeks. To prevent the build-up of sea growth, all OceanLED lights have been coated with a specialized Tritonium coating which makes the surface of the lens a non-stick layer which helps ward off long term barnacle buildup. Lights should be cleaned with a boat brush or similar biweekly or as needed to keep the lens of the light clear. Growth varies greatly around the world and maintenance is imperative to the proper operation and longevity of the product. If heavy fouling occurs, barnacles can be removed from the lens using a plastic scraper and moderate pressure. This can be done in the water using a plastic scraper. If out of water, moisten the growth before wiping.

CAUTION: Harsh cleaning solvents will damage the light and Tritonium coating.

4.3 - Troubleshooting problems and their solutions

Sport Series			
Problem	Check	Result	Fix
Light does not look bright.	Check that there is no marine growth on the lens.	Sea life / barnacles present.	Clean the lens as per instruction booklet.
	Check voltage supply to the light is between 11v and 32v DC (The light will still work between 9 and 11 volts however at reduced brightness).	Voltage is either too high or too low.	Investigate reason for high or low voltage.
	Check voltage supply is stable and does not fluctuate.	Voltage is fluctuating.	Investigate reason for voltage fluctuation and fix.
	Check that the electrical connections between the light and the supply cable have been made correctly and recommended cable gauge has been used.	Poor electrical connection.	Remake connection and seal joint correctly.
	Confirm all LEDs are illuminated.	1 or more LEDs are not working.	Contact your dealer. If the installation instructions have not been followed and as a result the light has been damaged. This is not covered by the warranty.
	Check lights to see if water is present inside the light.	Water present.	If water is present contact your dealer. If the installation instructions have not been followed and as a result the light has been damaged. This is not covered by the warranty.
Light does not light up.	Check that there is power supplied to the light cable connection.	Poor electrical connection.	Trace the cables back, checking at joints until break has been located.
	Check that the wiring polarity is correct, red to positive and black to negative.	Polarity incorrect.	Change the wiring polarity and seal joint correctly.
	Check that there is power supplied to the light cable connection.	Replace fuse.	If fuse keeps blowing then there is a short circuit in the light system that must be traced and rectified. If no external short can be located contact your local Oceanled representative.
Light has water inside.	Check connections to make sure they are not submerged in water.	Light will require replacing.	This is not covered by the warranty.
	Check cable to make sure there is no damage to the cable. (If cable is damaged, it must only be replaced by OceanLED, service agent or similar qualified person).	Light will require replacing.	This is not covered by the warranty.

Chapter 5: Appendix

SUPPLY CABLE CONDUCTOR SIZE CHART								
CABLE LENGTH (FEET)	CIRCUIT CURRENT							
	2 AMP	4 AMP	6 AMP	8 AMP	10 AMP	12 AMP	14 AMP	16 AMP
0-5	18 AWG	18 AWG	16 AWG	16 AWG	16 AWG	14 AWG	14 AWG	14 AWG
10-15	18 AWG	18 AWG	16 AWG	16 AWG	14 AWG	14 AWG	14 AWG	14 AWG
15-20	18 AWG	18 AWG	16 AWG	14 AWG	14 AWG	14 AWG	12 AWG	12 AWG
20-25	18 AWG	16 AWG	14 AWG	14 AWG	12 AWG	12 AWG	12 AWG	10 AWG
25-30	18 AWG	16 AWG	14 AWG	12 AWG	12 AWG	10 AWG	10 AWG	10 AWG
30-35	18 AWG	14 AWG	14 AWG	12 AWG	10 AWG	10 AWG	10 AWG	8 AWG
35-40	18 AWG	14 AWG	12 AWG	12 AWG	10 AWG	10 AWG	8 AWG	8 AWG
40-45	16 AWG	14 AWG	12 AWG	10 AWG	10 AWG	8 AWG	8 AWG	8 AWG
45-50	16 AWG	14 AWG	12 AWG	10 AWG	10 AWG	8 AWG	8 AWG	8 AWG
50-55	16 AWG	12 AWG	10 AWG	10 AWG	8 AWG	8 AWG	8 AWG	4 AWG
55-60	16 AWG	12 AWG	10 AWG	10 AWG	8 AWG	8 AWG	4 AWG	4 AWG
60-65	14 AWG	12 AWG	10 AWG	8 AWG	8 AWG	8 AWG	4 AWG	4 AWG
65-70	14 AWG	12 AWG	10 AWG	8 AWG	8 AWG	4 AWG	4 AWG	4 AWG
70-75	14 AWG	12 AWG	10 AWG	8 AWG	8 AWG	4 AWG	4 AWG	4 AWG
75-80	14 AWG	10 AWG	10 AWG	8 AWG	4 AWG	4 AWG	4 AWG	2 AWG
80-85	14 AWG	10 AWG	8 AWG	8 AWG	4 AWG	4 AWG	4 AWG	2 AWG
85-90	14 AWG	10 AWG	8 AWG	8 AWG	4 AWG	4 AWG	2 AWG	2 AWG
90-95	14 AWG	10 AWG	8 AWG	8 AWG	4 AWG	4 AWG	2 AWG	2 AWG
95-100	12 AWG	10 AWG	8 AWG	4 AWG	4 AWG	4 AWG	2 AWG	2 AWG



Chapter 6: Warranty Statement:

This warranty statement is for those products supplied to and sold from all territories internationally

OceanLED stands by its products. In general terms, the company gives a full 2 year's manufacturer's warranty on all of its products from date of sale from OceanLED.

Warranty replacements shall be covered for a period of 2 years from the date of the original product sale from OceanLED.

To claim, please contact an authorized OceanLED dealer and complete the troubleshooting guidelines and warranty claim form (available from www.oceanled.com). Claims may be disputed if the troubleshooting guidelines are not completed or no defect is found with the product. The detailed terms and conditions of this warranty are set out below.

However; please note that all metal parts corrode in salt water. The primary factors affecting corrosion are not directly related to our products and accordingly OceanLED cannot be held responsible for corrosion-related defects this includes where water has been allowed to enter the cable as a result of immersion in water during the installation or improper sealing of connections. Please note corrosion will be particularly aggressive if installation and/or bonding have not been undertaken properly; or if stray currents are active in the vicinity of a boat.

Colour variation occurs within the LED manufacture. While we make every effort to match the colour of any lights there may be a noticeable difference. OceanLED does not warrant this colour variation on lights.

OceanLED reserves the right to change the design, range and components without any prior notification either written or verbal.

OceanLED does not cover any charges incurred for hauling of vessels.

1: WARRANTY OF QUALITY

- 1.1 In the case of goods manufactured and sold by Ocean LED Marine LTD, a company incorporated in England and Wales (registered number 08927130) and whose registered office is at Unit 1 Jacknell Road, Dodwells Bridge Ind. Est. Hinckley, Leicestershire, LE10 3BS (the "Goods" and the "Company", respectively), the Company warrants to the purchaser of the Goods (the "Buyer") Conditions and unless otherwise notified) upon delivery (whether installed or not), and for a period of 2 years, that goods supplied shall be of satisfactory quality within the meaning of the Sale of Goods Act of 1979.
- 1.2 the Company shall not liable for a breach of the warranty in Condition 1.1 unless:
 - 1.2.1 the Buyer gives written notice of the defect to the Company, and to the carrier if the defect is as a result of damage in transit, within 14 days of the time when the Buyer discovers or ought to have discovered the defect; and
 - 1.2.2 the Buyer has the obligation to provide all the requested information where is reasonably possible and provided a truthful statement of all information requested in relation to the claim.
 - 1.2.3 the Buyer returns such Goods to the Company's place of business at the Buyers cost, regardless of the outcome of the claim.
 - 1.2.4 the Company is given a reasonable opportunity after receiving the returned Goods for the examination to take place at the Company's place of business.
- 1.3 the Company shall not be liable for a breach of the warranty in Condition 1.1 if:
 - 1.3.1 the Buyer makes any further use of such Goods after giving such notice; or
 - 1.3.2 the defect arises because the Buyer failed to follow the Company's oral or written instructions as to storage, transportation, installation, commissioning, modification, use or maintenance of the Goods or (if there are none) good trade practice; or the defect arises from the corrosion of metal parts or the failure of the Buyer to ensure that Goods are installed correctly, bonded correctly and that there are no active stray currents in the vicinity; or
 - 1.3.3 the defect arises as a result of any default of, or caused by, the Buyer or (without limitation) as a result of misuse, abuse, improper installation, neglect, improper shipping by a party other than the Company; or
 - 1.3.4 the Buyer alters, repairs or modifies such Goods without written consent of the Company; or

- 1.3.5 the defect arises due to a cause beyond the Company's reasonable control, such as: act of God, explosion, flood, tempest, fire or accident, including without limitation lightning; war or threat of war, national emergency, sabotage, terrorism, insurrection, protest, riot, epidemic, civil disturbance or requisition; Acts, restrictions, regulations, by-laws, prohibitions or measures of any kind on the part of any governmental, parliamentary or local authority; import or export regulations or embargoes; strikes, lock-outs or other industrial actions or trade disputes (whether involving employees of the Company or of a third party); restraints or delays affecting carriers or inability or delay in obtaining supplies of adequate or suitable materials; or power failure or breakdown in machinery.
- 1.3.6 where the Company has notified the Customer directly of in service modification(s) deemed necessary to further protect the Goods from damage have not been followed.
- 1.3.7 where a claim has been made where the Goods ownership is in dispute.
- 1.3.8 where the parts were not purchased from an authorized outlet.
- 1.3.9 where the goods were purchased via the internet from the United States but were not shipped to an address or fitted in the United States.
- 1.4 Subject to Conditions 1.2 and Condition 1.3, if any of the Goods do not conform with the warranty in Condition 1.1 the Company shall at its option repair or replace such Goods (or the defective part) without charge for labor or parts or refund the price of such Goods at the original purchase price. The Company shall pay for the return transportation to the Buyer of such repaired or replaced Goods.
- 1.5 Any Goods replaced shall belong to the Company and any such repaired or replacement Goods shall be guaranteed on these terms for the unexpired portion of the warranty period of the warranty in Condition 1.1.

2: LIMITATION OF LIABILITY

- 2. These Conditions set out the entire financial liability of the Company (including any liability for the acts or omissions of its employees, agents and sub-contractors) to the Buyer in respect of:
 - 2.1.1. Any breach of these Conditions;
 - 2.1.2 any defect in the Goods;
 - 2.1.3 any use made or resale by the Buyer of any Goods, or of any product incorporating any of Goods; and
 - 2.1.4 any representation, statement or tortious act or omission including negligence arising or in connection with the contract with the Buyer.
- 2.2. All warranty, conditions and other terms implied by both UK law are, to the fullest extent permitted by law, excluded from the contract with the Buyer.
- 2.3. Nothing in these conditions excludes or limits the liability of the Company;
 - 2.3.1. for death or personal injury caused by the Company's negligence;
 - 2.3.2 under both UK law;
 - 2.3.3 for any matter which it would be illegal for the Company to exclude or attempt to exclude its liability; or
 - 2.3.4 for fraud or fraudulent misrepresentation.
- 2.4. Subject to the above Condition 2.3:
 - 2.4.1 the Company's total liability in contract, (including without limitation negligence or breach of statutory duty), misrepresentation, restitution or otherwise, arising in connection with the performance or contemplated performance of the contract with the Buyer or (without limitation) in respect of the Goods shall be limited to the original purchase; and
 - 2.4.2 the Company shall not be liable to the Buyer for any pure economic loss, loss of profits, loss of business, loss of contracts, damage to property, depletion of goodwill or otherwise, in each case whether direct, indirect or consequential, or any claims for consequential whatsoever (however caused) which arise out of or in connection with the contract with the Buyer or (without limitation) the Goods.

3: THIRD PARTY RIGHTS

No term of any Contract formed between the Buyer and the Company shall be enforceable by virtue of the Contracts (Rights of Third Parties) Act 1999 by any person that is not a party to it.

4: APPLICABLE LAW

Each of (a) the sale of the Goods to the Buyer, (b) these conditions, and (c) any disputes or claims arising there from or in connection therewith shall be governed by and construed in accordance with the law of England; and the Buyer and the Company irrevocably agree that the Courts of England have exclusively jurisdiction to settle any dispute or claim that arises out of or in connection with the foregoing.

5: GREY MARKET INTERNET POLICY

Grey marketed products continue to be a threat to our worldwide distribution and dealer network. In order to proactively discourage this activity by Internet resellers of our product, OceanLED will not honor the warranty of products purchased via the grey market through internet resellers. The following notice will be added to OceanLED's warranty cards, website and all internet sellers will be required to post the same notice.

WARRANTY NOTIFICATION: OceanLED products purchased by an end-user from a United States dealer via the Internet are covered by this warranty, only if the products are delivered and installed within the United States. The warranty is void if the product is delivered or installed outside the United States. Proof of purchase and installation will be required. Product installed by OEM will be warranted when shipped as part of a new boat package.

6: MAKING A CLAIM

- 6.1 Irrespective of how the products were fitted or by whom when you discover that there may be a problem with the products you must notify either your local dealer or ourselves within 14 days.
 - 6.1.1 When you discover a problem we ask that the products that have a problem are not used. This will minimize any further damage. We recommend (especially with the pro series) that the product be disconnected to prevent accidental use by removing the power feed from the driver box and covering the end of the power lead with a waterproof solution (e.g. a taped up plastic bag) to prevent water entering the cable connectors.
 - 6.1.2 If a claim is accepted the part will be replaced on a "like for like basis". No refunds will be given.
 - 6.1.3 If you feel unhappy with any part of the process of claiming please let us know.
- 6.2 Products supplied and fitted by a dealer
 - 6.2.1 If you had the products installed by one of our dealers we ask that you contact them and ask that they check the installation and establish the cause of the problem. If you are not local to the installer please visit our website (www.oceanled.com) to find the authorized dealer closest to you. This is because many problems are due to issues with the installation or the electrical aspects external to the lighting system, and can be resolved without the need for the removal of the product.
 - 6.2.2 You should locate your purchase invoice for the products when you believe there is a problem and contact the dealer you purchased the products and / or who fitted them.
 - 6.2.3 Your dealer will contact us and together we will resolve your issues and together we will investigate.
 - 6.2.4 If the problem is found not to be due to the manufacture of the product, this will fall outside of the warranty cover and the buyer will be liable for all costs.
- 6.3 Products supplied by a dealer but fitted by the Buyer
 - 6.3.1 If you installed the products yourself, before making contact we ask that you follow the troubleshooting chart for your product, when following the appropriate troubleshooting chart we find that it is helpful to complete the appropriate warranty claim information sheet. Copies can be found in the troubleshoot section of the manual included with the product or alternatively it can be download from our website (www.oceanled.com/documents).
 - 6.3.2 If after following the troubleshoot guide, you still believe that the problem still exists with our product you will need to contact the dealer that you purchased the product(s) from, however if you are unable to do this you may contact any dealer / distributor in your local area (a list can be obtained either from our website (www.oceanled.com) or by contacting our Head Office.
 - 6.3.3 When you will be required to provide the information recorded on the warranty claim information sheet and have the copy of your purchase invoice for the products.
 - 6.3.4 When contacting your dealer you will be asked for the details from the warranty claim information sheet. During this time the dealer will complete the appropriate warranty claim form that will be returned along with the part.
 - 6.3.5 When you have made contact with the dealer please follow their instructions.
 - 6.3.6 If you are unable to contact a dealer you may wish to contact OceanLED directly. To contact the Service Manager either call our UK office on +44 1455637505 or email sales@oceanled.com.
- 6.4 If you are unable to locate a dealer close by or purchased directly from OceanLED.
 - 6.4.1 Before making contact we ask that you follow the troubleshooting chart for your product, when following the appropriate troubleshooting chart we find that it is helpful to complete the appropriate warranty claim information sheet. Copies can be found in the troubleshoot section of the manual included with the product or alternatively it can be download from our website (www.oceanled.com).
 - 6.4.2 If after following the troubleshoot guide, you still believe that the problem still exists with our product you will need to contact the Service Manager at OceanLED for your region.

If you are located in either North, Central or South America please contact the Warranty Department at:

OceanLED USA LLC
778 South Military Trail
Deerfield Beach
Florida
FL 33442-3025
United States
Tel:+1(954) 523-2250
Fax:+1(954) 523-2249
Email sales@oceanledusa.com

Or if you are located in any other area please contact the Warranty Department at our UK Head Office at:

Ocean LED Marine LTD
Unit 1 Jacknell Road
Dodwells Bridge Industrial Estate
Hinckley
Leicestershire LE10 3BS
United Kingdom
Tel: +44 1455 637505
Fax: +44 1455 238553
Email sales@oceanled.com

- 6.4.3 When you contact you will be required to provide the information recorded on the warranty claim information sheet and have the copy of your purchase invoice for the products where you believe there is a problem. The Service team will review with you your problem and where possible advise on any further checks that may be required to be done. If from the test results you do appear to have a problem you will be issued with a Warranty Claim number. The Claim number is unique to your claim and should be used in all correspondence and attached to the returned parts.
- 6.4.4 You will be required to return the faulty part with the attached WC number to the appropriate address in section 6.4.2. The return of the part is at your expense.
- 6.4.5 The part will be investigated and if the cause is established to be a manufacturing error or a problem with the components we will return a replacement part to you.
- 6.4.6 If you require a part urgently from us, you would be required to purchase a new one from us. You then have a maximum of 30 days to return the faulty part to us. We will investigate and if the product has a problem due to our manufacturing will provide a full refund. If you do not think that you can return the part to us within the 30 days please contact the Service Manager. If the product is not returned within the time limit the claim will be closed and no refund given.
- 6.4.7 If we are unable to find a problem with the part, we will inform you of the outcome. We can provide guidance to possible reasons for the fault. Unfortunately we are not liable for or can fix problems with equipment & installations that are not purchased from OceanLED. The returned product can be returned to you at your request.

Please remove this page and keep for your files

For technical assistance:

Europe: service@oceanled.com

The Americas: warranty@oceanledusa.com

Warranty Serial Code(s):

© 2017 Ocean LED Marine LTD
All Rights Reserved

Specifications are subject to change
without notice.

Trademarks are the property of
Ocean LED Marine LTD



Ocean LED Marine LTD
Unit 1 Jacknell Road
Dodwells Bridge Industrial Estate
Hinckley,
Leicestershire LE10 3BS
United Kingdom
Tel: +44 (0) 1455 637505
Fax: +44 (0) 1455 238553
sales@oceanled.com

Ocean LED USA LLC
778 South Military Trail
Deerfield Beach
Florida
FL 33442-3025
United States
Tel: +1 954.523.2250
Fax: +1 954.523.2249
sales@oceanledusa.com

