

GARMIN®



DESCENT™ MK3 SERIES

Owner's Manual

© 2023 Garmin Ltd. or its subsidiaries

All rights reserved. Under the copyright laws, this manual may not be copied, in whole or in part, without the written consent of Garmin. Garmin reserves the right to change or improve its products and to make changes in the content of this manual without obligation to notify any person or organization of such changes or improvements. Go to www.garmin.com for current updates and supplemental information concerning the use of this product.

Garmin®, the Garmin logo, ANT®, ANT+®, Approach®, Auto Lap®, Auto Pause®, Edge®, inReach®, Move IQ®, QuickFit®, TracBack®, VIRB®, Virtual Partner®, and Xero® are trademarks of Garmin Ltd. or its subsidiaries, registered in the USA and other countries. Descent™, Body Battery™, Connect IQ™, DiveView™, Firstbeat Analytics™, Garmin AutoShot™, Garmin Connect™, Garmin Dive™, Garmin Explore™, Garmin Express™, Garmin GameOn™, Garmin Golf™, Garmin Index™, Garmin Pay™, Health Snapshot™, HRM-Dual™, HRM-Pro™, HRM-Run™, HRM-Swim™, HRM-Tri™, NextFork™, PacePro™, Rally™, SatIQ™, SubWave™, tempe™, Varia™, and Vector™ are trademarks of Garmin Ltd. or its subsidiaries. These trademarks may not be used without the express permission of Garmin.

Android™ is a trademark of Google LLC. Applied Ballistics® is a registered trademark of Applied Ballistics, LLC. Apple®, iPhone®, iTunes®, and Mac® are trademarks of Apple Inc., registered in the U.S. and other countries. The BLUETOOTH® word mark and logos are owned by the Bluetooth SIG, Inc. and any use of such marks by Garmin is under license. The Cooper Institute®, as well as any related trademarks, are the property of The Cooper Institute. Di2™ is a trademark of Shimano, Inc. Shimano® is a registered trademark of Shimano, Inc. iOS® is a registered trademark of Cisco Systems, Inc. used under license by Apple Inc. Overwolf™ is a trademark of Overwolf Ltd. STRAVA and Strava™ are trademarks of Strava, Inc. Training Stress Score™ (TSS), Intensity Factor™ (IF), and Normalized Power™ (NP) are trademarks of Peaksware, LLC. Wi-Fi® is a registered mark of Wi-Fi Alliance Corporation. Windows® is a registered trademark of Microsoft Corporation in the United States and other countries. Zwift™ is a trademark of Zwift, Inc. Other trademarks and trade names are those of their respective owners.

This product is ANT+® certified. Visit www.thisisant.com/directory for a list of compatible products and apps.

Table of Contents

Introduction.....	1	Using the Gauge Dive Stopwatch.....	17
Getting Started.....	1	Using the Basic Dive Stopwatch.....	17
Device Overview.....	1	Viewing Transceiver Data During a	
Enabling and Disabling the		Dive.....	18
Touchscreen.....	2	Switching Gases During a Dive.....	18
Using the Watch.....	2	Switching Between CC and OC Diving	
Clearing User Data with the Kill Switch		for a Bailout Procedure.....	19
Feature.....	2	Performing a Safety Stop.....	19
		Performing a Decompression Stop..	20
		Diving with the Map.....	20
		Viewing the Surface Interval Glance....	21
		Viewing the Dive Log Glance.....	22
Diving.....	3	Dive Readiness.....	22
Dive Warnings.....	3	Dive Planning.....	22
Dive Modes.....	4	Calculating NDL Time.....	23
Using the Pool Dive Mode.....	4	Calculating Your Breathing Gas.....	23
Dive Setup.....	5	Creating a Decompression Plan.....	24
Dive Mode Advanced Settings.....	5	Using Decompression Plans.....	24
Setting Up Your Breathing Gases.....	6	Altitude Diving.....	24
Custom Dive Alerts.....	6	Tips for Wearing the Watch with an	
Setting a Custom Dive Alert.....	7	Exposure Suit.....	25
Setting PO2 Thresholds.....	7	Dive Alerts.....	26
Setting CCR Setpoints.....	8	Transceiver Alerts.....	28
No-Fly Time.....	8	Enabling Lost Transceiver Alerts.....	28
Air Integration.....	8	Dive Product and Feature	
Waking the Transceiver from Low		Compatibility.....	29
Power Mode.....	9	Dive Terminology.....	29
Pairing the Transceiver with a Descent			
Watch.....	9	Clocks.....	30
Transceiver Settings.....	10	Setting an Alarm.....	30
Selecting Transceivers to View During		Editing an Alarm.....	30
a Dive.....	10	Starting the Countdown Timer.....	30
Selecting the Gas Consumption Rate		Deleting a Timer.....	30
Metric.....	10	Using the Stopwatch.....	31
Including Transceivers in Gas		Adding Alternate Time Zones.....	31
Consumption Calculations.....	11	Editing an Alternate Time Zone.....	32
Updating the Transceiver Software			
Using Your Watch.....	11	Activities and Apps.....	32
Dive Data Screens.....	11	Starting an Activity.....	32
Single-Gas and Multi-Gas Data		Tips for Recording Activities.....	32
Screens.....	12	Stopping an Activity.....	33
CCR Data Screens.....	13	Evaluating an Activity.....	33
Gauge Data Screens.....	14	Running.....	33
Apnea and Apnea Hunt Data		Going for a Track Run.....	33
Screens.....	14	Tips for Recording a Track Run....	34
Big Numbers Mode.....	15	Going for a Virtual Run.....	34
Going Diving.....	16	Calibrating the Treadmill Distance... 34	
Navigating with the Dive Compass..	17		

Recording an Ultra Run Activity.....	34	Viewing Tide Information.....	45
Recording an Obstacle Racing Activity.....	35	Setting a Tide Alert.....	46
Swimming.....	35	Anchor.....	46
Swim Terminology.....	35	Marking Your Anchor Location....	46
Stroke Types.....	35	Anchor Settings.....	47
Tips for Swimming Activities.....	36	Trolling Motor Remote.....	47
Auto Rest and Manual Rest.....	36	Pairing Your Watch and Trolling Motor.....	47
Training with the Drill Log.....	36	Skiing and Winter Sports.....	47
Multisport.....	36	Viewing Your Ski Runs.....	47
Triathlon Training.....	37	Recording a Backcountry Skiing or Snowboarding Activity.....	48
Creating a Multisport Activity.....	37	Cross-Country Skiing Power Data....	48
Indoor Activities.....	37	Golfing.....	49
Health Snapshot™.....	37	Playing Golf.....	49
Recording a Strength Training Activity.....	38	Golf Menu.....	51
Recording a HIIT Activity.....	38	Moving the Flag.....	51
Using an Indoor Trainer.....	39	Virtual Caddie.....	52
Gaming.....	39	PlaysLike Distance Icons.....	52
Using the Garmin GameOn™ App.....	39	PlaysLike Distance Factors.....	52
Recording a Manual Gaming Activity.....	40	PlaysLike Settings.....	53
Climbing Sports.....	40	Measuring Distance with Touch Targeting.....	53
Recording an Indoor Climbing Activity.....	40	Viewing Measured Shots.....	53
Recording a Bouldering Activity.....	41	Manually Measuring a Shot.....	53
Starting an Expedition.....	41	Keeping Score.....	53
Recording a Track Point Manually...	41	Recording Statistics.....	54
Viewing Track Points.....	41	Scoring Settings.....	54
Going Hunting.....	42	About Stableford Scoring.....	54
Marine Activities.....	42	Viewing the Wind Speed and Direction.....	54
Sailing.....	42	Viewing the Direction to the Pin.....	55
Tack Assist.....	42	Saving Custom Targets.....	55
Calibrating the Tack Assist.....	43	Big Numbers Mode.....	55
Entering a Fixed Tack Angle.....	43	Swing Tempo Training.....	56
Entering a True Wind Direction.....	43	The Ideal Swing Tempo.....	56
Tips for Getting the Best Lift Estimate.....	43	Analyzing Your Swing Tempo.....	57
Sail Racing.....	43	Viewing the Tip Sequence.....	57
Setting the Starting Line.....	44	Jumpmaster.....	57
Starting a Race.....	44	Planning a Jump.....	57
Water Sports.....	45	Jump Types.....	57
Viewing Your Water Sport Runs....	45	Entering Jump Information.....	58
Fishing.....	45	Entering Wind Information for HAHO and HALO Jumps.....	58
Going Fishing.....	45	Resetting Wind Information.....	58
Tides.....	45	Entering Wind Information for a Static Jump.....	58

Constant Settings.....	59	Calibrating the Drop Scale Factor.....	71
Customizing Activities and Apps.....	59	Viewing the Drop Scale Factor Table.....	71
Adding or Removing a Favorite Activity.....	59	Editing the Muzzle Velocity and Temperature Table.....	71
Changing the Order of an Activity in the Apps List.....	59	Clearing the Muzzle Velocity and Temperature Table.....	71
Customizing the Data Screens.....	60	Applied Ballistics Glossary of Terms...	72
Adding a Map to an Activity.....	60	Training..... 74	
Creating a Custom Activity.....	60	Unified Training Status.....	74
Activities and App Settings.....	61	Syncing Activities and Performance Measurements.....	75
Activity Alerts.....	63	Training for a Race Event.....	75
Setting an Alert.....	64	Race Calendar and Primary Race.....	75
Activity Map Settings.....	64	Workouts.....	75
Routing Settings.....	64	Starting a Workout.....	76
Using ClimbPro.....	65	Workout Execution Score.....	76
Enabling Auto Climb.....	65	Following a Workout From Garmin Connect.....	76
Satellite Settings.....	66	Following a Daily Suggested Workout.....	77
Segments.....	66	Starting an Interval Workout.....	77
Strava™ Segments.....	66	Customizing an Interval Workout.....	77
Viewing Segment Details.....	66	Recording a Critical Swim Speed Test.....	78
Racing a Segment.....	67	Using Virtual Partner®.....	78
Applied Ballistics®..... 67		Setting a Training Target.....	78
AB Synapse - Garmin App.....	67	Racing a Previous Activity.....	79
Applied Ballistics Options.....	68	About the Training Calendar.....	79
Quickly Editing Shooting Conditions.....	68	Using Garmin Connect Training Plans.....	79
Environment.....	68	Adaptive Training Plans.....	79
Editing the Environment.....	68	PacePro Training.....	79
Enabling Auto Update.....	68	Downloading a PacePro Plan from Garmin Connect.....	80
Range Card.....	69	Creating a PacePro Plan on Your Watch.....	80
Customizing the Range Card Fields.....	69	Starting a PacePro Plan.....	81
Editing the Range Increment.....	69	Power Guide.....	82
Setting the Base Range.....	69	Creating and Using a Power Guide..	82
Targets.....	69	History..... 82	
Changing the Target.....	69	Using History.....	83
Editing the Target.....	69	Multisport History.....	83
Profile.....	69	Personal Records.....	83
Selecting a Different Profile.....	69		
Adding a Profile.....	70		
Deleting a Profile.....	70		
Customizing the Profile Data Screen.....	70		
Editing Bullet Properties.....	70		
Editing Gun Properties.....	70		
Calibrating the Muzzle Velocity....	70		

Viewing Your Personal Records.....	83
Restoring a Personal Record.....	83
Clearing Personal Records.....	84
Viewing Data Totals.....	84
Using the Odometer.....	84
Deleting History.....	84

Appearance..... 84

Watch Face Settings.....	84
Default Watch Face.....	85
Customizing the Watch Face.....	85
Glances.....	86
Viewing the Glance Loop.....	89
Customizing the Glance Loop.....	90
Creating Glance Folders.....	90
Body Battery.....	90
Tips for Improved Body Battery Data.....	90
Performance Measurements.....	91
About VO2 Max. Estimates.....	92
Getting Your VO2 Max. Estimate for Running.....	92
Getting Your VO2 Max. Estimate for Cycling.....	93
Viewing Your Predicted Race Times.....	93
Heart Rate Variability Status.....	94
Heart Rate Variability and Stress Level.....	94
Performance Condition.....	95
Viewing Your Performance Condition.....	95
Getting Your FTP Estimate.....	96
Conducting an FTP Test.....	96
Lactate Threshold.....	97
Performing a Guided Test to Determine Your Lactate Threshold.....	97
Viewing Your Real-Time Stamina.....	98
Viewing Your Power Curve.....	98
Training Status.....	99
Training Status Levels.....	100
Tips for Getting Your Training Status.....	100
Acute Load.....	100
Training Load Focus.....	101
Load Ratio.....	101

About Training Effect.....	102
Recovery Time.....	102
Recovery Heart Rate.....	102
Heat and Altitude Performance Acclimation.....	103
Pausing and Resuming Your Training Status.....	103
Training Readiness.....	104
Endurance Score.....	104
Hill Score.....	105
Viewing Cycling Ability.....	105
Adding a Stock.....	105
Adding Weather Locations.....	106
Using the Jet Lag Adviser.....	106
Planning a Trip in the Garmin Connect App.....	106
Controls.....	106
Customizing the Controls Menu....	109
Using the LED Flashlight.....	109
Editing the Custom Flashlight Strobe.....	110
Using the Flashlight Screen.....	110
Garmin Pay.....	110
Setting Up Your Garmin Pay Wallet.....	110
Paying for a Purchase Using Your Watch.....	110
Adding a Card to Your Garmin Pay Wallet.....	111
Managing Your Garmin Pay Cards.....	111
Changing Your Garmin Pay Passcode.....	111
Morning Report.....	111
Customizing Your Morning Report.	111

Sensors and Accessories..... 111

Wrist Heart Rate.....	111
Wearing the Watch.....	112
Tips for Erratic Heart Rate Data....	112
Wrist Heart Rate Monitor Settings.	113
Setting an Abnormal Heart Rate Alert.....	113
Broadcasting Heart Rate Data....	113
Pulse Oximeter.....	114
Getting Pulse Oximeter Readings..	115
Setting the Pulse Oximeter Mode..	115

Tips for Erratic Pulse Oximeter Data.....	115	Marine Map Settings.....	128
Compass.....	115	Showing and Hiding Map Data.....	128
Setting the Compass Heading.....	115	Music..... 128	
Compass Settings.....	116	Connecting to a Third-Party Provider	129
Calibrating the Compass		Downloading Audio Content from a	
Manually.....	116	Third-Party Provider.....	129
Setting the North Reference.....	116	Downloading Personal Audio	
Altimeter and Barometer.....	116	Content.....	129
Altimeter Settings.....	117	Listening to Music.....	130
Calibrating the Barometric		Music Playback Controls.....	130
Altimeter.....	117	Connecting Bluetooth Headphones...	130
Barometer Settings.....	117	Changing the Audio Mode.....	130
Calibrating the Barometer.....	117	Connectivity..... 131	
Wireless Sensors.....	118	Phone Connectivity Features.....	131
Pairing Your Wireless Sensors.....	120	Pairing Your Phone.....	131
HRM-Pro Running Pace and		Enabling Bluetooth Notifications...	131
Distance.....	120	Viewing Notifications.....	131
Tips for Recording Running Pace		Receiving an Incoming Phone	
and Distance.....	121	Call.....	132
Running Dynamics.....	121	Replying to a Text Message.....	132
Tips for Missing Running Dynamics		Managing Notifications.....	132
Data.....	121	Turning Off the Bluetooth Phone	
Running Power.....	122	Connection.....	132
Running Power Settings.....	122	Turning On and Off Phone Connection	
Using the Varia Camera Controls...	122	Alerts.....	132
inReach Remote.....	122	Turning On and Off Find My Phone	
Using the inReach Remote.....	123	Alerts.....	132
VIRB Remote.....	123	Locating a Phone Lost During a GPS	
Controlling a VIRB Action		Activity.....	133
Camera.....	123	Playing Audio Prompts During an	
Controlling a VIRB Action Camera		Activity.....	133
During an Activity.....	124	Wi-Fi Connectivity Features.....	133
Xero Laser Location Settings.....	124	Connecting to a Wi-Fi Network.....	134
Map..... 124		Phone Apps and Computer	
Viewing the Map.....	125	Applications.....	134
Saving or Navigating to a Location on		Garmin Connect.....	134
the Map.....	125	Using the Garmin Connect App..	135
Navigating with the Around Me		Updating the Software Using the	
Feature.....	126	Garmin Connect App.....	135
Map Settings.....	126	Using Garmin Connect on Your	
Managing Maps.....	127	Computer.....	135
Downloading Maps with Outdoor		Updating the Software Using	
Maps+.....	127	Garmin Express.....	135
Downloading TopoActive Maps.	127	Manually Syncing Data with Garmin	
Deleting Maps.....	128	Connect.....	135
Map Themes.....	128	Connect IQ Features.....	135

Downloading Connect IQ Features.....	136	Navigating to the Starting Point of a Saved Activity.....	146
Downloading Connect IQ Features Using Your Computer.....	136	Navigating to Your Starting Point During an Activity.....	146
Garmin Dive App.....	136	Viewing Route Directions.....	147
Garmin Explore™.....	136	Navigating with Sight 'N Go.....	147
Garmin Golf App.....	136	Marking and Starting Navigation to a Man Overboard Location.....	147
User Profile.....	136	Stopping Navigation.....	147
Setting Up Your User Profile.....	136	Courses.....	147
Gender Settings.....	137	Creating and Following a Course on Your Device.....	148
Viewing Your Fitness Age.....	137	Creating a Round-Trip Course.....	148
About Heart Rate Zones.....	137	Creating a Course on Garmin Connect.....	148
Fitness Goals.....	137	Sending a Course to Your Device.....	149
Setting Your Heart Rate Zones.....	138	Viewing or Editing Course Details..	149
Letting the Watch Set Your Heart Rate Zones.....	138	Projecting a Waypoint.....	149
Heart Rate Zone Calculations.....	139	Navigation Settings.....	149
Setting Your Power Zones.....	139	Customizing Navigation Data Screens.....	150
Detecting Performance Measurements Automatically.....	139	Setting Up a Heading Bug.....	150
		Setting Navigation Alerts.....	150
Safety and Tracking Features.....	140	Power Manager Settings.....	150
Adding Emergency Contacts.....	140	Customizing the Battery Saver Feature.....	151
Adding Contacts.....	140	Changing the Power Mode.....	151
Turning Incident Detection On and Off.....	141	Customizing Power Modes.....	151
Requesting Assistance.....	141	Restoring a Power Mode.....	151
Starting a GroupTrack Session.....	142	System Settings.....	152
Tips for GroupTrack Sessions.....	142	Time Settings.....	152
GroupTrack Settings.....	142	Setting Time Alerts.....	153
		Syncing the Time.....	153
Health and Wellness Settings.....	143	Changing the Screen Settings.....	153
Auto Goal.....	143	Customizing Sleep Mode.....	154
Using the Move Alert.....	143	Customizing the Hot Keys.....	154
Intensity Minutes.....	143	Changing the Units of Measure.....	154
Earning Intensity Minutes.....	143	Viewing Device Information.....	154
Sleep Tracking.....	143	Viewing E-label Regulatory and Compliance Information.....	154
Using Automated Sleep Tracking...	144	Device Information.....	155
Navigation.....	144	About the AMOLED Display.....	155
Viewing and Editing Your Saved Locations.....	144	Charging the Watch.....	155
Saving a Dual Grid Location.....	144		
Setting a Reference Point.....	144		
Navigating to a Destination.....	145		
Navigating to a Point of Interest....	145		

Specifications.....	156
Battery Information.....	156
Device Care.....	157
Cleaning the Watch.....	158
Changing the QuickFit® Bands.....	158
Extra Long Diving Band.....	158
Metal Watch Band Adjustment.....	158
Data Management.....	158
Deleting Files.....	159

Ground Contact Time Balance Data.....	180
Vertical Oscillation and Vertical Ratio Data.....	181
VO2 Max. Standard Ratings.....	181
FTP Ratings.....	182
Endurance Score Ratings.....	183
Wheel Size and Circumference.....	184
Symbol Definitions.....	184

Troubleshooting..... 159

Product Updates.....	159
Getting More Information.....	159
My device is in the wrong language...	159
Is my phone compatible with my watch?.....	159
My phone will not connect to the watch.....	160
Can I use my Bluetooth sensor with my watch?.....	160
My headphones will not connect to the watch.....	160
My music cuts out or my headphones won't stay connected.....	160
Restarting Your Watch.....	160
Resetting All Default Settings.....	161
Diving.....	161
Resetting Your Tissue Load.....	161
Resetting the Surface Pressure.....	161
Tips for Maximizing the Battery Life..	162
Acquiring Satellite Signals.....	162
Improving GPS Satellite Reception	162
The activity temperature reading is not accurate.....	162
Activity Tracking.....	162
My step count does not seem accurate.....	163
The step counts on my watch and my Garmin Connect account don't match.....	163
The floors climbed amount does not seem accurate.....	163

Appendix..... 164

Data Fields.....	164
Color Gauges and Running Dynamics Data.....	180

Introduction

⚠ WARNING

See the *Important Safety and Product Information* guide in the product box for product warnings and other important information.

Always consult your physician before you begin or modify any exercise program.

Getting Started

When using your watch the first time, you should complete these tasks to set it up and get to know the basic features.

- 1 Press **LIGHT** to turn on the watch ([Device Overview, page 1](#)).
- 2 Follow the on-screen instructions to complete the initial setup.
During the initial setup, you can pair your phone with your watch to receive notifications, sync your activities, and more ([Pairing Your Phone, page 131](#)). If you are upgrading from a compatible watch, you can migrate your watch settings, saved courses, and more when you pair your new Descent watch with your phone.
- 3 Charge the watch ([Charging the Watch, page 155](#)).
- 4 Start an activity ([Starting an Activity, page 32](#)).

Device Overview



① Touchscreen

- Tap to choose an option in a menu.
- Hold the watch face data to open the glance or feature.
NOTE: This feature is not available on all watch faces.
- Swipe up or down to scroll through the glance loop and menus.
- Swipe right to return to the previous screen.
- Cover the screen with your palm to return to the watch face and turn down the screen brightness.

② LIGHT

- Press to turn on the device.
- Press to illuminate the screen.
- Quickly press twice to turn on the flashlight.
- Hold to view the controls menu.

③ UP-MENU

- Press to scroll through the glance loop and menus.
- Hold to view the menu.

④ DOWN

- Press to scroll through the glance loop and menus.
- Hold to view the music controls from any screen.

⑤ START-STOP

- Press to choose an option in a menu.
- Press to view the activity list and start or stop an activity.

⑥ BACK-LAP

- Press to return to the previous screen.
- Press to record a lap, rest, or transition during a multisport activity.
- Hold to view a list of your recently used apps from any screen.

Enabling and Disabling the Touchscreen

- Hold **DOWN** and **START**.
- Hold **LIGHT**, and select .
- Hold **MENU**, select **System** > **Touch**, and select an option.

Using the Watch

- Hold **LIGHT** to view the controls menu ([Controls](#), page 106).
The controls menu provides quick access to frequently used functions, such as turning on do not disturb mode, saving a location, and turning the watch off.
- From the watch face, press **UP** or **DOWN** to scroll through the glance loop ([Glances](#), page 86).
- From the watch face, press **START** to start an activity or open an app ([Activities and Apps](#), page 32).
- Hold **MENU** to customize the watch face ([Customizing the Watch Face](#), page 85), adjust settings ([System Settings](#), page 152), pair wireless sensors ([Pairing Your Wireless Sensors](#), page 120), and more.

Clearing User Data with the Kill Switch Feature

The Kill Switch feature quickly removes all saved user-entered data and resets all settings to the factory default values.

- 1 Customize a button or button combination for the **Kill Switch** feature ([Customizing the Hot Keys](#), page 154).
- 2 Hold the button or button combination you customized to activate the **Kill Switch** feature.

TIP: You can press any button to cancel the Kill Switch feature during a 10-second countdown.

After 10 seconds, the watch deletes all user-entered data.

Diving

Dive Warnings

WARNING

- The diving features of this device are for use by certified divers only. This device should not be used as a sole dive computer. Failure to input the appropriate dive-related information into the device can lead to serious personal injury or death.
- Make sure that you fully understand the use, displays, and limitations of your device. If you have questions about this manual or the device, always resolve any discrepancies or confusion before diving with the device. Always remember that you are responsible for your own safety.
- There is always a risk of decompression illness (DCI) for any dive profile even if you follow the dive plan provided by the dive tables or a diving device. No procedure, diving device, or dive table will eliminate the possibility of DCI or oxygen toxicity. An individual's physiological make up can vary from day to day. This device cannot account for these variations. You are strongly advised to remain well within the limits provided by this device to minimize the risk of DCI. You should consult a physician regarding your fitness before diving.
- The dive computer can calculate your surface air consumption rate (SAC) and air time remaining (ATR). These calculations are an estimate and should not be relied on as the only source of information.
- Always use backup instruments, including a depth gauge, submersible pressure gauge, and timer or watch. You should have access to decompression tables when diving with this device.
- Perform pre-dive safety checks, such as checking proper device function and settings, display function, battery level, tank pressure, and bubble checks to check hoses for leaks.
- If a tank pressure warning or battery warning appears on the dive computer, terminate the dive immediately and safely return to the surface. Disregarding the alarm may result in serious injury or death.
- This device should not be shared between multiple users for diving purposes. Diver profiles are user specific, and using another diver's profile can result in misleading information that could lead to injury or death.
- For safety reasons, you should never dive alone. Dive with a designated buddy. You should also stay with others for an extended time after a dive, because the potential onset of decompression illness (DCI) may be delayed or triggered by surface activities.
- This device is not intended for commercial or professional dive activities. It is for recreational purposes only. Commercial or professional dive activities can expose the user to extreme depths or conditions that increase the risk of DCI.
- Do not dive with a gas if you have not personally verified its contents and input the analyzed value to the device. Failure to verify tank contents and input the appropriate gas values to the device will result in incorrect dive planning information and could result in serious injury or death.
- Diving with more than one gas mixture presents a much greater risk than diving with a single gas mixture. Mistakes related to the use of multiple gas mixtures may lead to serious injury or death.
- The transceiver is not an oxygen cleaned product. Do not use the transceiver with anything greater than 40% oxygen.
- Always ensure a safe ascent. A rapid ascent increases the risk of DCI.
- Disabling the deco lockout feature on the device can result in an increased risk of DCI, which can result in personal injury or death. Disable this feature at your own risk.
- Violating a required decompression stop may result in serious injury or death. Never ascend above the displayed decompression stop depth.
- Always perform a safety stop between 3 and 5 meters (9.8 and 16.4 feet) for 3 minutes, even if no decompression stop is required.

Dive Modes

The Descent device supports six dive modes. Each dive mode has four phases: dive pre-check, surface display, in-dive, and post-dive. During the pre-dive check, you can confirm the dive settings before you start diving ([Dive Setup, page 5](#)). The surface phase shows the data screens for the dive mode ([Dive Data Screens, page 11](#)). The in-dive phase shows data about the dive in progress, and other watch features, such as GPS, are disabled ([Going Diving, page 16](#)). During the post-dive review, you can view a summary of the completed dive ([Viewing the Dive Log Glance, page 22](#)).

Single-Gas: This mode allows you to dive with a single gas blend. You can set up to 11 additional gases as backup gases.

Multi-Gas: This mode allows you to configure multiple gas blends and switch gases during your dive. You can set the oxygen content from 5–100%. This mode supports one bottom gas, and up to 11 additional gases as decompression or backup gases.

NOTE: Backup gases are not used in no-decompression limit (NDL) and time to surface (TTS) decompression calculations until you activate them during a dive.

CCR: This mode for closed-circuit rebreather (CCR) diving allows you to configure two partial pressure of oxygen (PO2) setpoints, closed-circuit (CC) diluent gases, and open-circuit (OC) decompression and backup gases.

Gauge: This mode allows you to dive with basic bottom timer features.

NOTE: After diving in gauge mode, the device can only be used in gauge or apnea mode for 24 hours.

Apnea: This mode allows you to free dive with apnea-specific dive data. This mode has a higher data refresh rate.

Apnea Hunt: This mode is similar to the Apnea dive mode, but tuned specifically for spearfishers. This mode disables start and stop tones.

Using the Pool Dive Mode

When the device is in pool dive mode, the tissue load and decompression lockout features function normally, but dives are not saved to the dive log.

1 Hold **LIGHT** to view the controls menu.

2 Select .

The pool dive mode turns off automatically at midnight.

Dive Setup

You can customize the dive settings based on your needs. Not all settings are applicable for all dive modes. You can also edit the settings before you start a dive.

Hold **MENU**, and select **Dive Setup**.

Gases: Sets the gas blends used in the gas dive modes ([Setting Up Your Breathing Gases, page 6](#)). You can have up to twelve gases for each gas dive mode.

Dive Network & Air Integration: Allows you to pair Descent transceivers and configure the data screens ([Air Integration, page 8](#)).

Conservatism: Sets the level of conservatism for decompression calculations. Higher conservatism provides a shorter bottom time and a longer ascent time. The Custom option allows you to set a custom gradient factor.

NOTE: Make sure you understand gradient factors before entering a custom level of conservatism.

Water Type: Allows you to select the water type.

PO2: Sets the partial pressure of oxygen (PO2) thresholds, in bar, for the maximum operating depth (MOD), decompression, warnings, and critical alerts ([Setting PO2 Thresholds, page 7](#)).

Scuba Alerts: Allows you to set custom alerts for gas dives ([Custom Dive Alerts, page 6](#)).

Apnea Alerts: Allows you to set custom alerts for apnea dives ([Custom Dive Alerts, page 6](#)).

Display Settings: Allows you to enable or disable Big Numbers mode and customize the data screens for each dive mode ([Dive Data Screens, page 11](#)).

Safety Stop: Allows you to change the safety stop duration.

Last Deco Stop: Allows you to set the depth of the final decompression stop.

End Dive Delay

Allows you to set the length of time before the device ends and saves a dive after surfacing.

CCR Setpoints: Allows you to set high and low PO2 setpoints for closed-circuit rebreather (CCR) dives ([Setting CCR Setpoints, page 8](#)).

Dive Shortcuts: Allows you to assign button shortcuts for use during dives.

Advanced Settings: Allows you to customize advanced dive mode settings ([Dive Mode Advanced Settings, page 5](#)).

Dive Mode Advanced Settings

Hold **MENU**, and select **Dive Setup > Advanced Settings**.

Double Tap to Scroll: Allows you to double tap the device to scroll through the dive data screens. If you notice accidental scrolling, you can use the Sensitivity option to adjust the responsiveness.

UP Key: Allows you to enable or disable the UP button during dive activities to prevent inadvertent button presses.

Silent Diving: Allows you to disable all tones and vibrations for alerts during dive activities.

Heart Rate: Allows you to enable or disable a heart rate monitor for dives. The Stored Strap Data option allows you to enable a chest heart rate monitor, such as the HRM-Pro™ series accessory, that stores heart rate data with the dive. You can view chest heart rate monitor data in the Garmin Dive™ app after you complete the dive.

Compass: Allows you to calibrate and set the north reference of the dive compass ([Calibrating the Compass Manually, page 116](#)).

No-Fly Time: Allows you to set the no-fly countdown timer mode ([No-Fly Time, page 8](#)).

Satellites: Sets the satellite system to use for dive entry and exit locations for each dive mode ([Satellite Settings, page 66](#)).

Units: Sets the distance, depth, and tank pressure units of measure for diving.

Deco Lockout: Allows you to disable the decompression lockout feature. This feature prevents single-gas, multi-gas, and CCR dives for 24 hours if you violate a decompression ceiling for more than three minutes.

NOTE: You can still disable the decompression lockout feature after violating a decompression ceiling.

Setting Up Your Breathing Gases

You can enter up to twelve gases for each gas dive mode. Decompression calculations include your decompression gases, but do not include your backup gases.

1 Hold **MENU**.

2 Select **Dive Setup > Gases**.

3 Select a dive mode.

4 Select the first gas in the list.

For single-gas or multi-gas dive modes, this is the bottom gas. For the closed-circuit rebreather (CCR) dive mode, this is the diluent gas.

5 Select **Oxygen**, and enter the oxygen percentage of the gas blend.

6 Select **Helium**, and enter the helium percentage of the gas blend.

The device calculates the remaining percentage as the nitrogen content.

7 Press **BACK**.

8 Select an option:

NOTE: Not all options are available for all dive modes.

- Select **Add Backup**, and enter the oxygen and helium percentage for your backup gas.
- Select **Add New**, enter the oxygen and helium percentage, and select **Mode** to set the intended use for the gas, such as decompression or backup.

NOTE: For the multi-gas dive mode, you can select **Set as Travel Gas** to set a decompression gas as your intended gas for descending.

Custom Dive Alerts

You can set custom dive alerts to help you train toward a specific goal or to increase your awareness of your environment.

Alert Name	Dive Mode	Description
Depth	Single-gas, multi-gas, CCR, gauge, apnea, or apnea hunt.	The alert occurs when you reach the selected depth.
High Speed	Apnea or apnea hunt.	The alert occurs when your vertical speed exceeds the selected speed.
Low Speed	Apnea or apnea hunt.	The alert occurs when your vertical speed drops below the selected speed.
Neutral Buoyancy	Apnea or apnea hunt.	The alert occurs when you reach the selected depth.
Surface Timer	Apnea or apnea hunt.	The alert occurs when the selected time interval elapses.
Target Depth	Apnea or apnea hunt.	The alert occurs when you reach the selected depth.
Time	Single-gas, multi-gas, CCR, gauge, apnea, or apnea hunt.	The alert occurs when the selected time interval elapses.
Variometer	Apnea or apnea hunt.	The alert occurs every time you reach the selected depth interval.
Start	Apnea or apnea hunt.	The alert occurs when you start a dive.
Stop	Apnea or apnea hunt.	The alert occurs when you stop a dive.

Setting a Custom Dive Alert

- 1 Hold **MENU**.
- 2 Select **Dive Setup**.
- 3 Select an option:
 - Select **Scuba Alerts**.
 - Select **Apnea Alerts**.
- 4 Select an option:
 - Select **Add Alert** to add a new alert.
 - Select the alert name to edit an existing alert.
- 5 If necessary, enable the alert.
- 6 Select an option:

NOTE: Not all options are available for all alert types.

- Select **Depth** to specify the depth that should trigger the alert.
- Select **Time** to specify the time interval that should trigger the alert.
- Select **Speed** to specify the vertical speed threshold that should trigger the alert.
NOTE: You can set the alert to trigger when your vertical speed exceeds or drops below the selected speed.
- Select **Interval** to specify if the alert should trigger once or at a repeat interval.
- Select **Direction** to specify if the alert should be enabled for ascending, descending, or both.
- Select **Dive Types** to specify which dive modes should allow the alert to trigger.
- Select **Sound and Vibe** to set the alert tone, vibration, or neither.
- Select **Pop-up** to enable a pop-up notification for the alert.
- Select **Preview Alert** to see how the alert appears and sounds during a dive.

Setting PO2 Thresholds

You can configure the partial pressure of oxygen (PO2) alert message thresholds, in bar.

- 1 Hold **MENU**.
- 2 Select **Dive Setup > PO2**.
- 3 Select an option:
 - Select **MOD/Deco PO2** to set the maximum operating depth (MOD) and decompression PO2 threshold for your planned bottom gas before you should begin your ascent and switch to the decompression gas with the highest percentage of oxygen.
NOTE: The watch does not switch gases for you automatically. You must select the gas.
 - Select **PO2 Warning** to set the threshold for the highest oxygen concentration level that you are comfortable reaching.
 - Select **PO2 Critical** to set the threshold for the maximum oxygen concentration level that you should reach.
- 4 Enter a value.

If you reach the PO2 Critical threshold value during a dive, the watch displays an alert message ([Dive Alerts, page 26](#)).

Setting CCR Setpoints

You can configure the high and low partial pressure of oxygen (PO₂) setpoints for closed-circuit rebreather (CCR) dives.

- 1 Hold **MENU**.
- 2 Select **Dive Setup > CCR Setpoints**.
- 3 Select an option:
 - To configure the lower PO₂ setpoint, select **Low Setpoint**.
 - To configure the upper PO₂ setpoint, select **High Setpoint**.
- 4 Select **Mode**.
- 5 Select an option:
 - To automatically change the setpoint based on your current depth, select **Auto**.
NOTE: For example, if you descend through the high setpoint depth or ascend through the low setpoint depth, the PO₂ threshold switches to the high or low setpoint, respectively. Automatic setpoint depths must be at least 6.1 m (20 ft.) apart.
 - To manually change setpoints during a dive, select **Manual**.
NOTE: If you manually change setpoints within 1.8 m (6 ft.) of an automatic switch depth, then automatic setpoint switching is disabled until you are more than 1.8 m (6 ft.) above or below the automatic switch depth. This prevents unintended setpoint switching.
- 6 Select **PO₂**, and enter a value.
- 7 If necessary, select **Depth**, and enter a depth value for the automatic setpoint change.

No-Fly Time

After a dive, you may need to wait several hours before it is safe to fly on an airplane. To indicate your remaining no-fly time,  appears on the default watch face, along with a no-fly time estimate in hours ([Default Watch Face, page 85](#)). You can view more details on the surface interval glance ([Viewing the Surface Interval Glance, page 21](#)).

TIP: You can add the no-fly indicator to a custom watch face ([Customizing the Watch Face, page 85](#)).

Hold **MENU**, and select **Dive Setup > Advanced Settings > No-Fly Time**.

No-Fly Time Mode	Dive Type	No-Fly Time
Standard or 24 Hours	Dive duration of 3 minutes or less or depth of 5 m (15 ft.) or less.	0 hours
Standard	Non-decompression dive more than 48 hours since the previous dive.	12 hours
Standard	Multiple non-decompression dives within 48 hours.	18 hours
Standard	Dive with a completed decompression stop.	24 hours
24 Hours	Non-gauge dive that did not violate the decompression plan.	24 hours
Standard or 24 Hours	Gauge dive or a dive that violated the decompression plan.	48 hours

Air Integration

The Descent Mk3i watch can be used with a paired Descent transceiver to view tank pressure, depth, estimated air time remaining, and estimated gas consumption. You can also view the tank pressure and battery status for up to four other divers in your group. For more information about the Descent transceiver, see the owner's manual for your device.

Waking the Transceiver from Low Power Mode

Out of the box, the transceiver is in low power mode. You must wake the transceiver from low power mode to pair and connect to it.

Select an option:

- Install the transceiver on the first-stage regulator, and gradually open the tank valve to pressurize the regulator.

NOTE: This option is not available for Bluetooth® pairing. Bluetooth technology is disabled when the transceiver is pressurized.

- Twist the battery cover counter-clockwise 270 degrees, wait 30 seconds, then twist the battery cover clockwise until it is secure.

The transceiver plays a tone when it wakes from low power mode and is ready to connect to your Descent watch ([Pairing the Transceiver with a Descent Watch, page 9](#)) or phone.

Pairing the Transceiver with a Descent Watch

Before you use the transceiver for the first time, you must pair it with the a compatible Descent watch using ANT® technology.

- 1 Wake the transceiver from low power mode ([Waking the Transceiver from Low Power Mode, page 9](#)).
- 2 On your Descent watch, hold **MENU**, and select **Dive Setup > Dive Network & Air Integration > Transmitters > Add New**.

The watch starts searching and displays a list of nearby transceivers.

- 3 From the list of transceivers, select the transceiver ID you want to pair.

The transceiver ID is printed on the housing.

When the pairing process is complete, the transceiver begins sending data, and it is ready to use on a dive. The next time the transceiver and watch are turned on and within wireless range, they connect automatically when you start a dive.

If you are diving with a group, you can pair up to 8 Descent transceivers with the watch.

Transceiver Settings

You can customize the settings for paired transceivers prior to a dive.

On the paired Descent watch, hold **MENU**, select **Dive Setup > Dive Network & Air Integration > Transmitters**, and select a transceiver.

Status: Enables a connection to the transceiver, and shows the current connection status.

Placement: Sets the transceiver location as either your own tank or that of another diver.

Public Tank Name: Allows you to associate a name with your transceiver, which will be visible to your dive group.

NOTE: If you customize this name, another option appears in the list to clear the name.

Nickname: Allows you to associate a nickname with another user's transceiver, which will be visible on your dive data screens.

NOTE: If you customize this name, another option appears in the list to clear the name.

Identify: Plays a tone on the selected paired transceiver. This helps you to identify the transceiver without needing to look at the transceiver ID printed on the transceiver housing.

Working Pressure: Sets how much pressure the tank has when full. This value is used to determine the upper end of the pressure gauge, and to calculate respiratory minute volume (RMV) for tanks using psi units.

Reserve Pressure: Sets the threshold values for reserve pressure and critical pressure alerts to appear on the watch.

Volume: Allows you to enter the air volume of the tank. You can use the Reset Volume option if you move the transceiver to a different size tank.

NOTE: This value is required to calculate volumetric surface air consumption (SAC) and respiratory minute volume (RMV) ([Selecting the Gas Consumption Rate Metric, page 10](#)).

SAC/RMV/ATR: Enables the transceiver to be included in volumetric surface air consumption (SAC), respiratory minute volume (RMV), and air time remaining (ATR) estimates ([Including Transceivers in Gas Consumption Calculations, page 11](#)).

Set Transmit Power: Allows you to adjust the power setting if your transceiver is losing connection with the paired watch underwater.

About: Displays the transceiver ID, software version, and battery status.

Remove: Allows you to remove a paired transceiver.

Selecting Transceivers to View During a Dive

You can view two paired transceivers at-a-glance on the primary dive data screen. You can customize which paired transceivers appear on the screen. By default, the first and second transceivers that you pair appear ([Viewing Transceiver Data During a Dive, page 18](#)).

- 1 Hold **MENU**.
- 2 Select **Dive Setup > Dive Network & Air Integration > Display Setup**.
- 3 Select a field to customize.
- 4 Select a paired transceiver.

Selecting the Gas Consumption Rate Metric

- 1 Hold **MENU**.
- 2 Select **Dive Setup > Dive Network & Air Integration > Display Setup > Gas Consumption Rate**.
- 3 Select an option.

NOTE: The watch can estimate volumetric surface air consumption (SAC) or respiratory minute volume (RMV) only if the air volume of the tank is entered in the watch ([Transceiver Settings, page 10](#)). The watch can estimate pressure-based surface air consumption (PSAC) with or without the air volume of the tank.

Including Transceivers in Gas Consumption Calculations

Gas consumption and air time remaining estimates are calculated using the tank pressure from the included transceivers. By default, the first transceiver that you pair with your compatible dive computer is included. You can include additional paired transceivers in gas consumption calculations.

- 1 Hold **MENU**.
- 2 Select **Dive Setup > Dive Network & Air Integration > Transmitters**.
- 3 Select a paired transceiver.
- 4 Select the **SAC/RMV/ATR** toggle switch to include the transceiver in gas consumption calculations.
- 5 If necessary, repeat steps 2 through 4 to include additional paired transceivers in gas consumption calculations.

Updating the Transceiver Software Using Your Watch

Before you can update the software, you must pair your Descent transceiver with a Descent Mk3i watch.

- 1 Select an option to sync your watch:
 - Sync your watch with the Garmin Dive app.
 - Connect the watch to your computer using the USB cable, and sync with the Garmin Express™ application.The Garmin Dive app and Garmin Express application automatically look for software updates. When you sync with the Garmin Dive app, you will be prompted to apply the update at a later time. When you sync with the Garmin Express application, the update is applied immediately to your watch.
- 2 Wake the transceiver from low power mode ([Waking the Transceiver from Low Power Mode, page 9](#)).
- 3 On the paired Descent watch, hold **MENU**, select **Dive Setup > Dive Network & Air Integration > Transmitters**, and select your transceiver.
- 4 Wait for the transceiver to connect to your watch.
Connected appears on the watch screen.
- 5 Select **Update Available**, press **START**, and select **Install Now**.
NOTE: The Update Available option may take up to a minute to appear while the watch determines the transceiver's software version and battery status. If the battery status is low or critically low, you must replace the battery before you can install the update.
- 6 Keep the watch near the transceiver until the software update is complete.

Dive Data Screens

You can press **DOWN** or double-tap the device to scroll through the data screens.

In the activity settings, you can reorder the default data screens, add a dive stopwatch, and add custom data screens ([Customizing the Data Screens, page 60](#)). You can customize the data fields on some of the data screens.

Single-Gas and Multi-Gas Data Screens

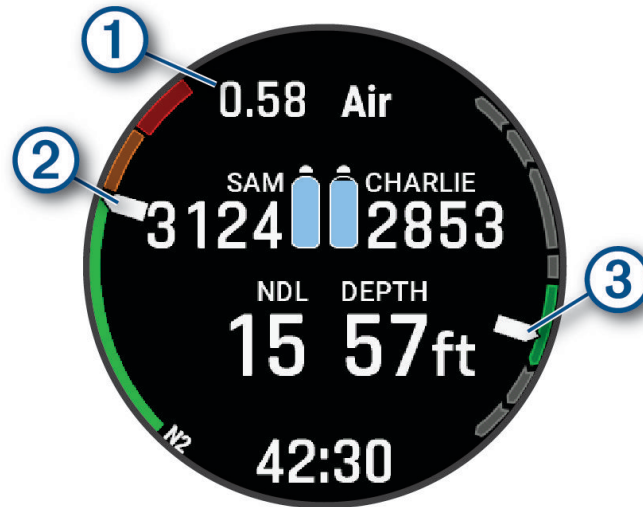

The primary data screen for single-gas and multi-gas dive modes displays the main dive data, including your breathing gas and rate of ascent or descent. You can press **DOWN** to scroll through additional data, including time of day and heart rate, and view the dive compass (*Navigating with the Dive Compass, page 17*).

NOTE: The single-gas dive mode has Big Numbers mode enabled by default (*Big Numbers Mode, page 15*).





① Your partial pressure of oxygen (PO₂) level.

Your nitrogen (N₂) and helium (He) tissue load level.

- ②
-  Green: 0 to 79% tissue load.
 -  Yellow: 80 to 99% tissue load.
 -  Red: 100% or greater tissue load.

Your rate of ascent.

- ③
-  Green: Good. Ascent is less than 7.9 m (26 ft.) per minute.
 -  Yellow: Moderately high. Ascent is between 7.9 and 10.1 m (26 and 33 ft.) per minute.
 -  Red: Too high. Ascent is greater than 10.1 m (33 ft.) per minute.

CCR Data Screens

The primary data screen for the CCR dive mode displays the main dive data, including your breathing gas and rate of ascent or descent. You can press **DOWN** to scroll through additional data, including your central nervous system (CNS) oxygen toxicity level and your current oxygen toxicity units (OTU) (*Viewing the Surface Interval Glance, page 21*), and view the dive compass (*Navigating with the Dive Compass, page 17*).

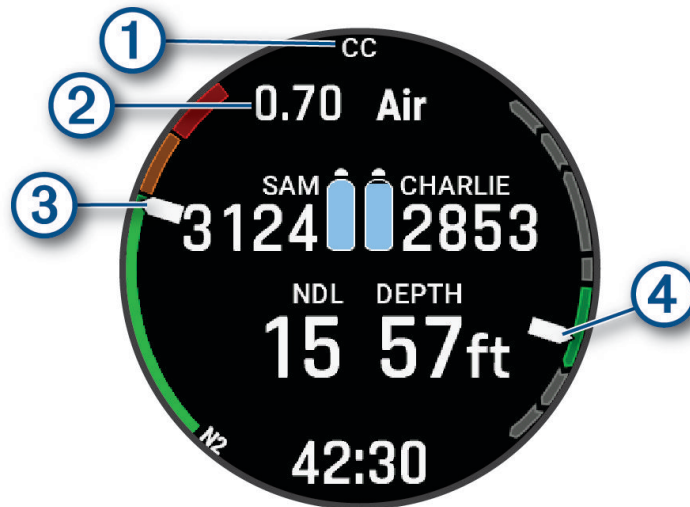

① Indicates whether closed-circuit (CC) or open-circuit (OC) diving is active.

② Your partial pressure of oxygen (PO₂) level.

Your nitrogen (N₂) and helium (He) tissue load level.

- ③
- Green: 0 to 79% tissue load.
 - Yellow: 80 to 99% tissue load.
 - Red: 100% or greater tissue load.

Your rate of descent or ascent.

- ④
- Green: Good. Ascent is less than 7.9 m (26 ft.) per minute.
 - Yellow: Moderately high. Ascent is between 7.9 and 10.1 m (26 and 33 ft.) per minute.
 - Red: Too high. Ascent is greater than 10.1 m (33 ft.) per minute.

Gauge Data Screens

The primary data screen for the gauge dive mode displays data for the current dive, including the current, maximum, and average depth and the stopwatch (*Using the Gauge Dive Stopwatch, page 17*). You can press **DOWN** to scroll through additional data, including time of day and heart rate, and view the dive compass (*Navigating with the Dive Compass, page 17*).



Apnea and Apnea Hunt Data Screens

The in-dive screen for the apnea and apnea hunt dive modes displays information about the current dive, including the elapsed time, current maximum depth, and rate of ascent or descent. During surface intervals, you can press **DOWN** to scroll through additional data, including last dive depth and time, view the map screen (*Diving with the Map, page 20*), and use the stopwatch (*Using the Basic Dive Stopwatch, page 17*).



Big Numbers Mode

You can change the size of the numbers on the single-gas, multi-gas, and CCR dive data screens.

- 1 Hold **MENU**.
- 2 Select **Dive Setup > Display Settings**.
- 3 Select **Single-Gas Mode, Multi-Gas Mode, or CCR Mode**.
- 4 Select **Big Numbers**.

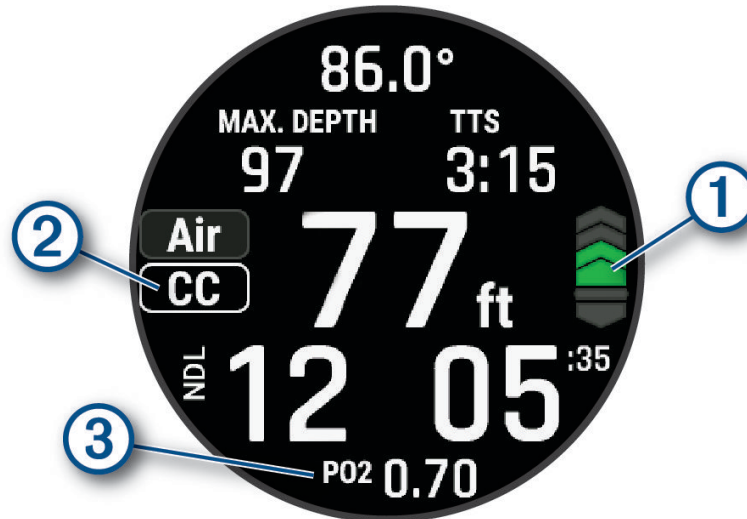

Your rate of ascent.



Green: Good. Ascent is less than 7.9 m (26 ft.) per minute.

①



Yellow: Moderately high. Ascent is between 7.9 and 10.1 m (26 and 33 ft.) per minute.



Red: Too high. Ascent is greater than 10.1 m (33 ft.) per minute.

②

Indicates whether closed-circuit (CC) or open-circuit (OC) diving is active in a CCR dive.

③

Your partial pressure of oxygen (PO₂) level.

Going Diving

- 1 From the watch face, press **START**.
- 2 Select a dive mode (*Dive Modes, page 4*).
- 3 If necessary, press **UP** to edit the dive settings, such as the gases, water type, and alerts (*Dive Setup, page 5*).
- 4 Wait with your wrist out of the water until the watch acquires GPS signals and the status bar is filled (optional).
The watch requires GPS signals to save your dive entry location.
- 5 Press **START** until the primary dive data screen appears.
- 6 Descend to start your dive.
The activity timer starts automatically when you reach a depth of 1.2 m (4 ft.).
NOTE: If you start a dive without selecting a dive mode, the watch uses the most recently used dive mode and settings, and your dive entry location is not saved.
- 7 Select an option:
 - Press **DOWN** to scroll through the data screens and dive compass.
TIP: You can also double tap the watch to scroll through the data screens. For an **Apnea** or **Apnea Hunt** dive, you can only scroll through the data screens during a surface interval.
 - Press **START** to view the in-dive menu.
- 8 When you are ready to end the dive, ascend to the surface.
- 9 Keep your wrist out of the water so the watch can acquire GPS signals and save your dive exit location (optional).
- 10 Select an option:
 - For a **Single-Gas, Multi-Gas, CCR, or Gauge** dive, wait for the **DIVE END** timer to count down.
NOTE: When you ascend to 1 m (3.3 ft.), the **DIVE END** timer begins counting down (*Dive Setup, page 5*). You can press **START**, and select **Stop Dive** to save the dive before the timer elapses.
 - For an **Apnea** or **Apnea Hunt** dive, press **BACK**, and select **Save**.
The watch saves the dive activity.
TIP: You can view your diving history in the dive log glance (*Viewing the Dive Log Glance, page 22*).

Navigating with the Dive Compass

- 1 During a **Single-Gas**, **Multi-Gas**, **CCR**, or **Gauge** dive, scroll to the dive compass.

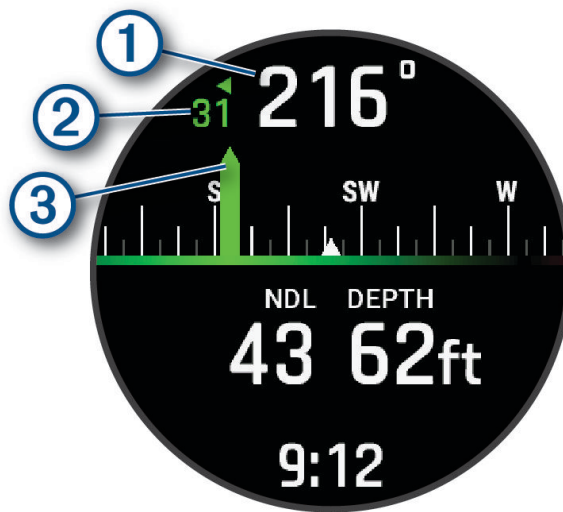

- The compass indicates your directional heading ①.
- 2 Press **START** to set the heading.
The compass indicates deviations ② from the set heading ③.
 - 3 Press **START**, and select an option:
 - To reset the heading, select **Reset Heading**.
 - To change the heading by 180 degrees, select **Set to Recip..**
NOTE: The compass indicates the reciprocal heading with a red mark.
 - To set to a 90-degree heading left or right, select **Set to 90L** or **Set to 90R**.
 - To clear the heading, select **Clear Heading**.

Using the Gauge Dive Stopwatch

- 1 Start a **Gauge** dive.
- 2 Press **START**, and select **Reset Avg. Depth** to set the average depth to your current depth.
- 3 Press **START**, and select **Start Stopwatch**.
- 4 Select an option:
 - To stop using the stopwatch, press **START**, and select **Stop Stopwatch**.
 - To restart the stopwatch, press **START**, and select **Reset Stopwatch**.

Using the Basic Dive Stopwatch

- 1 Select an option:
 - Add the **Stopwatch Timer** data screen to the **Single-Gas**, **Multi-Gas**, **CCR**, or **Gauge** dive mode.
 - Enable the **STOPWATCH** surface data screen for the **Apnea** or **Apnea Hunt** dive mode.
- 2 During a gas dive or apnea surface interval, scroll to the stopwatch screen.
TIP: During an apnea surface interval, you can press and hold **START** to open the stopwatch and start the timer, even if the screen is not enabled.
- 3 Press **START** to start the timer.
- 4 Press **STOP** to stop the timer.
- 5 Press **BACK** to reset the timer.

Viewing Transceiver Data During a Dive

1 Press **DOWN** to view the data screen.

TIP: You can customize the dive data screens to view the transceiver and diver dashboard data on dedicated data screens (*Customizing the Data Screens*, page 60).

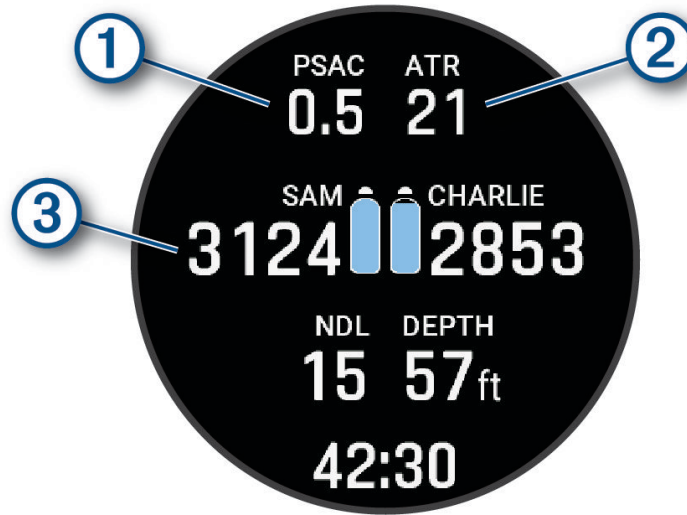

The gas consumption estimate for the selected transceivers.

① **NOTE:** You can customize the transceivers used for gas calculations (*Including Transceivers in Gas Consumption Calculations*, page 11).

② The air time remaining (ATR) estimate for the selected transceivers.

Your primary and secondary transceivers and their tank pressure values.

③ **NOTE:** You can customize which transceivers are displayed (*Selecting Transceivers to View During a Dive*, page 10).

2 Press **START**, and select **Divers** to view the tank pressure values and approximate depths of the paired Descent transceivers in the network.

Switching Gases During a Dive

1 Start a single-gas, multi-gas, or closed-circuit rebreather (CCR) dive.

2 Select an option:

- Press **START**, select **Gas**, and select a backup or decompression gas.

NOTE: If necessary, you can select **Add New** and enter a new gas.

- Dive until you reach the **MOD/Deco PO2** threshold (*Setting PO2 Thresholds*, page 7).

The device prompts you to switch to the gas with the highest percentage of oxygen.

NOTE: The device does not switch gases for you automatically. You must select the gas.

Switching Between CC and OC Diving for a Bailout Procedure

During a closed-circuit rebreather (CCR) dive, you can switch between closed-circuit (CC) and open-circuit (OC) diving while you perform a bailout procedure.

- 1 Start a CCR dive.
- 2 Press **START**.
- 3 Select **Switch to OC**.

The dividing lines on the data screens turn red, and the device switches the active breathing gas to your OC decompression gas.

NOTE: If you have not set up an OC decompression gas, the device switches to your diluent gas.

- 4 If necessary, press **START**, and select **Gas** to manually switch to a backup gas.
- 5 Press **START**, and select **Switch to CC** to switch back to CC diving.

Performing a Safety Stop

You should perform a safety stop during every dive to help reduce the risk of decompression sickness.

- 1 After a dive of at least 11 m (35 ft.), ascend to 5 m (15 ft.).
Safety stop information appears on the data screens.

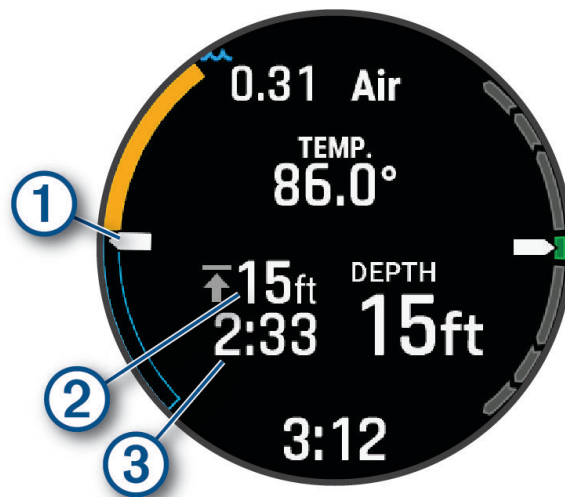

- | | |
|---|---|
| ① | Your depth relative to the surface.
As you ascend, your position moves upward toward the safety stop depth. |
| ② | The safety stop ceiling depth. |
| ③ | The safety stop timer.
When you are within 1 m (5 ft.) of the ceiling depth, the timer starts counting down. |

- 2 Stay within 2 m (8 ft.) of the safety stop ceiling depth until the safety stop timer reaches zero.
NOTE: If you ascend more than 3 m (8 ft.) above the safety stop ceiling depth, the safety stop timer pauses, and the device alerts you to descend below the ceiling depth. If you descend below 11 m (35 ft.), the safety stop timer resets.
- 3 Continue ascending to the surface.

Performing a Decompression Stop

You should always perform all the required decompression stops during a dive to help reduce the risk of decompression sickness. Missing a decompression stop adds significant risk.

- 1 When you exceed the no-decompression limit (NDL) time, begin your ascent.
Decompression stop information appears on the data screens.

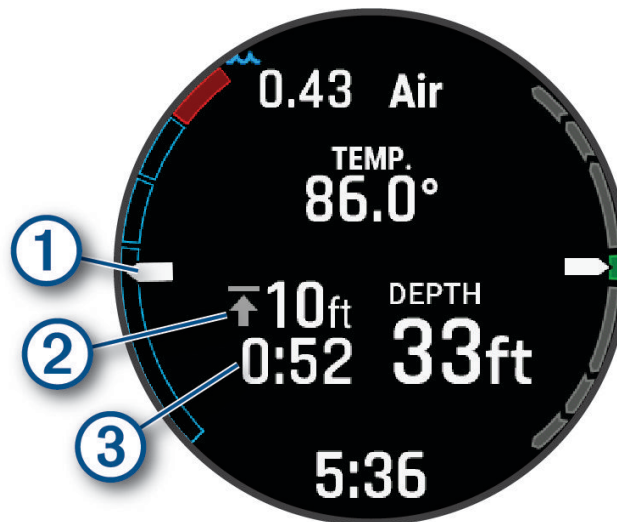

Your depth relative to the surface.

- 1 As you ascend, your position moves upward toward the required decompression stop depth. The empty segments represent cleared stops. You may clear a stop before ascending to it.

- 2 The decompression stop ceiling depth.

- 3 The decompression stop timer.

- 2 Stay within 0.6 m (2 ft.) of the decompression stop ceiling depth until the decompression stop timer reaches zero.

NOTE: If you ascend more than 0.6 m (2 ft.) above the decompression stop ceiling depth, the decompression stop timer pauses, and the device alerts you to descend below the ceiling depth. The depth and ceiling depth flash red until you are within the safe margin.

- 3 Continue ascending to the surface or the next decompression stop.

Diving with the Map

You can view your dive entry and exit locations on the map during apnea surface intervals. With DiveView™ maps enabled, you can view shading for coastal depth zones and terrain ([Managing Maps, page 127](#)).

TIP: You can view map data for all dive modes in the dive log glance and in the Garmin Dive app.

- 1 During an apnea dive activity, scroll to the map.

- 2 Press **START**, and select an option:

- To pan or zoom the map, select **Pan/Zoom**.

TIP: You can press **START** to toggle between panning up and down, panning left and right, or zooming. You can hold **START** to select the point indicated by the crosshairs.

- To mark your location, select **Save Location**.

TIP: You can press **DOWN** to change the icon.

Viewing the Surface Interval Glance

- 1 From the watch face, press **UP** or **DOWN** to view the surface interval glance.
- 2 Press **START** to view your current oxygen toxicity units (OTU) and central nervous system (CNS) percentage.
NOTE: The OTU accumulated during a dive expire after 24 hours.

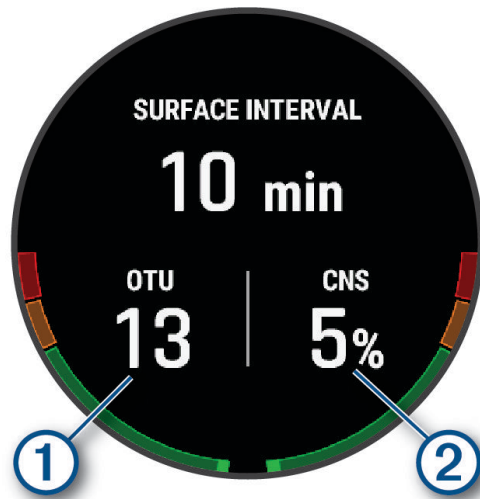

①

- Green: 0 to 249 OTU.
- Yellow: 250 to 299 OTU.
- Red: 300 or greater OTU.

②

- Green: 0 to 79% CNS oxygen toxicity.
- Yellow: 80 to 99% CNS oxygen toxicity.
- Red: 100% or greater CNS oxygen toxicity.

- 3 Press **DOWN** to view your tissue load details.
- 4 Press **DOWN** to view your no-fly time remaining and the time of day the no-fly period ends.

Viewing the Dive Log Glance

The glance displays summaries of your recently recorded dives.





- 1 From the watch face, press **UP** or **DOWN** to view the dive log glance.
- 2 Press **START** to view your most recent dive.
- 3 Press **DOWN** > **START** to view a different dive (optional).
- 4 Press **START**, and select an option:
 - To view additional information about the activity, select **All Stats**.
 - To view additional information about one of multiple apnea dives in the activity, select **Dives**, and select a dive.
 - To view the activity on a map, select **Map**.
NOTE: The watch shows your entry and exit locations if you waited for GPS signals before and after the dive.
 - To save a dive entry or exit location, select **Save Location**.
 - To view a depth graph for the activity, select **Depth Profile**.
 - To view a temperature graph for the activity, select **Temperature Plot**.
 - To view the gases you used, select **Gas Switches**.
 - To remove the activity from your watch, select **Delete**.

NOTE: Deleting an activity from the dive log glance does not impact tissue loading calculations.

Dive Readiness

Your dive readiness is a score and a short message that can help you decide whether you are ready to dive. The score is continuously calculated and updated throughout the day using these factors:

- Sleep score (last night)
- Recovery time
- Body battery
- Jet lag
- Dive history
- Sleep history (last 3 nights)
- Training status

Color Zone	Score	Description
 Green	75 to 100	Good Ready to dive
 Yellow	50 to 74	Moderate Stay focused
 Orange	25 to 49	Low Be cautious
 Red	1 to 24	Poor Rest before diving

To see your dive readiness trends over time, go to your Garmin Dive account.

Dive Planning

You can plan for future dives using your device. The device can calculate no-decompression limit (NDL) times or create decompression plans. When planning a dive, the device uses your residual tissue load from recent dives in the calculations.

Calculating NDL Time

You can calculate the no-decompression limit (NDL) time or maximum depth for a future dive. These calculations are not saved or applied to your next dive.

- 1 Press **START**.
- 2 Select **Plan Dive > Compute NDL**.
- 3 Select an option:
 - To calculate NDL based on your current tissue load, select **Diving Now**.
 - To calculate NDL based on your tissue load at a future time, select **Enter Surf. Interval**, and enter your surface interval time.
- 4 Enter an oxygen percentage.
- 5 Select an option:
 - To calculate the NDL time, select **Enter Depth**, and enter the planned depth for your dive.
 - To calculate the maximum depth, select **Enter Time**, and enter your planned dive time.The NDL countdown clock, depth, and maximum operating depth (MOD) appear.

NOTE: If the planned depth exceeds the MOD of the breathing gas, a warning message appears, and the depth appears in red.
- 6 Press **START**.
- 7 Select an option:
 - To exit, select **Done**.
 - To add intervals to your dive, select **Add Repeat Dive**, and follow the on-screen instructions.

Calculating Your Breathing Gas

You can calculate the PO₂ value, oxygen percentage, or maximum depth for a dive by adjusting two of the three values. The calculations are affected by the water type setting in the Dive Setup menu ([Dive Setup, page 5](#)).

- 1 Press **START**.
- 2 Select **Plan Dive > Calculate Gas**.
- 3 Press **UP** or **DOWN**, and select an option to calculate:
 - Select **PO₂**.
 - Select **O₂%**.
 - Select **Depth**.
- 4 Press **UP** or **DOWN** to edit the first value.
- 5 Press **START**, then press **UP** or **DOWN** to edit the second value.

As you edit the values, the device calculates an adjusted value for the highlighted option.
- 6 If necessary, press **BACK** to calculate the value for a different option.

Creating a Decompression Plan

You can create open-circuit decompression plans and save them for future dives.

- 1 Press **START**.
- 2 Select **Plan Dive > Deco Plans > Add New**.
- 3 Enter a name for the decompression plan.
- 4 Select an option:
 - To enter the maximum partial pressure of oxygen in bars, select **PO2**.
NOTE: The device uses the PO2 value for gas switching.
 - To enter your level of conservatism for decompression calculations, select **Conservatism**.
 - To enter your gas blends, select **Gases**.
 - To enter the depth of your last decompression stop, select **Last Deco Stop**.
 - To enter the maximum dive depth, select **Bottom Depth**.
 - To enter the time at the bottom depth, select **Bottom Time**.
- 5 Select **Save**.

Using Decompression Plans

- 1 Press **START**.
- 2 Select **Plan Dive > Deco Plans**.
- 3 Select a decompression plan.
- 4 Select an option:
 - To view the decompression plan, select **View**.
 - To use the decompression plan settings for a dive mode, select **Apply**.
 - To change the decompression plan details, select **Edit**.
 - To edit the name of the decompression plan, select **Rename**.
 - To remove the decompression plan, select **Delete > Yes**.

Altitude Diving

At higher altitudes, the atmospheric pressure is lower, and your body contains a larger amount of nitrogen than it would at the start of a dive at sea level. The device accounts for altitude changes automatically using the barometric pressure sensor. The absolute pressure value used by the decompression model is not affected by the altitude or the gauge pressure displayed on the watch.

Tips for Wearing the Watch with an Exposure Suit

- Use the extra long silicone diving band to wear the watch over a thick exposure suit.
- Use the extension ① on the titanium watch band to increase the length of the band.

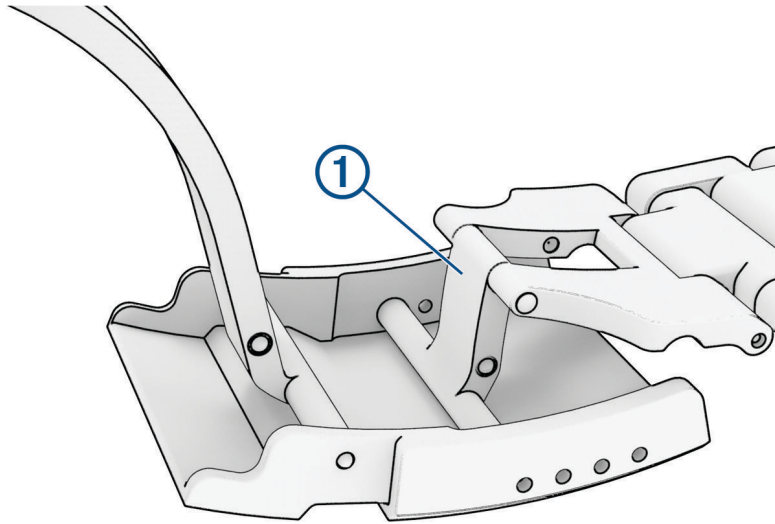

- Turn off the wrist-based heart rate monitor to increase battery life ([Wrist Heart Rate Monitor Settings](#), page 113).

Dive Alerts

Alert Message	Cause	Watch Action
None	You completed the decompression stop.	The decompression stop depth and time flash blue for five seconds.
None	Your partial pressure of oxygen (PO2) value is above the specified warning value.	Your PO2 value flashes yellow.
%1 OTU accumulated. End your dive now.	Your oxygen toxicity units are above the safe limit. During a dive, "%1" is replaced with the number of units accumulated.	The alert appears every two minutes, up to three times.
250 OTU accumulated.	Your oxygen toxicity units (OTU) are at 250 units, and you are nearing the safe limit of 300 units.	None
Approaching Deco Stop	You are within one stop interval (3 m or 9.8 ft.) of the decompression stop depth.	None
Approaching NDL	You have 10 minutes of no decompression limit (NDL) time remaining.	The alert appears again when you have 5 minutes of NDL time remaining.
Ascending too fast. Slow your ascent.	You are ascending faster than 9.1 m/min. (30 ft./min.) for more than 5 seconds.	None
Battery critically low. End your dive now.	Less than 10% battery power remains.	The alert appears when the watch is below 10% battery power and on the dive pre-check screen for your next dive.
Battery is low.	Less than 20% battery power remains.	The alert appears when the watch is below 20% battery power and on the dive pre-check screen for your next dive.
Continuing on %1. Switch at any time.	You selected Not Now when prompted to switch to a higher-oxygen gas, or you ignored the prompt.	The watch marks the gas as a backup and updates decompression guidance accordingly.
CNS toxicity at %1%. End your dive now.	Your CNS oxygen toxicity is too high. During a dive, "%1" is replaced with your current CNS percentage.	The alert appears every two minutes, up to three times.
CNS toxicity at 80%.	Your central nervous system (CNS) oxygen toxicity is at 80% of the safe limit.	The alert appears during a dive and on the dive pre-check screen for your next dive.
Decompression Cleared	You completed all decompression stops.	None
Descend below deco ceiling.	You are more than 0.6 m (2 ft.) above the decompression ceiling.	The current depth and stop depth flash red. If you remain above the decompression ceiling for more than three minutes, the decompression lockout feature goes into effect.
Descend to complete safety stop.	You are more than 2 m (8 ft.) above the safety stop ceiling.	The current depth and stop depth flash yellow.

Alert Message	Cause	Watch Action
Diluent PO2 is low. Flushing may be dangerous.	The PO2 of the diluent gas is too low, and filling the rebreather breathing loop with the diluent gas may be dangerous.	None
Dive will end in %1 seconds.	The watch will automatically end and save the dive. During a dive, "%1" is replaced by the number of seconds.	None
Do not dive. Failed to read depth sensor.	The watch has invalid or missing depth sensor data before you start a dive activity.	Do not start a dive. Call Garmin® Product Support.
Failed to read depth sensor. End your dive now.	The watch has invalid or missing depth sensor data after you have started a dive activity.	Use a backup dive computer or dive plan and end your dive. Call Garmin Product Support.
NDL exceeded. Decompression now required.	You have exceeded your NDL time.	The watch begins providing decompression stop guidance.
No more gas switch alerts will be issued.	You selected Never when prompted to switch to a higher-oxygen gas.	The watch marks the gas as a backup and updates decompression guidance accordingly. It will no longer prompt you to switch to the gas.
PO2 is high. Ascend or switch to lower O2 gas.	Your PO2 value is above the specified critical value.	Your PO2 value flashes red. The alert appears every 30 seconds, up to three times, until you ascend to a safe level or switch gases.
PO2 is low. Descend or switch to higher O2 gas.	Your PO2 value is below 0.18 bar.	If you are within the first two minutes of your dive, your PO2 value flashes yellow. Otherwise, your PO2 value flashes red. The alert appears every 30 seconds, up to three times, until you descend to a safe level or switch gases.
Safety Stop Cleared	You completed the safety stop.	None
Safety Stop Started	You ascended above 6 m (20 ft.) without other decompression guidance.	The safety stop countdown timer begins, if configured.
Safe to switch to %1. Switch now?	In a multi-gas dive, a gas with a higher oxygen content is now safe to breathe. During a dive, "%1" is replaced with the name of the gas.	You can switch gases now, or wait to switch gases later in the dive. A confirmation message for your choice appears.
Switched to high setpoint.	The watch automatically switched to your specified CCR high setpoint.	None
Switched to low setpoint.	The watch automatically switched to your specified CCR low setpoint.	None
This pool dive will not be saved to the dive log.	The watch is in pool dive mode.	The watch will not save the current dive to the dive log.
Watch rebooted. Evaluate dive conditions.	The watch rebooted during the dive.	The watch simulates the dive for the time it was rebooting. Since other alerts

Alert Message	Cause	Watch Action
		may not have been triggered, evaluate your current depth and dive conditions.

Transceiver Alerts

Alert Message	Cause	Device Action
None	Your paired watch has lost communication with the transceiver for 30 seconds.	The tank pressure value flashes yellow.
%1 is below reserve pressure.	Your tank pressure is below the reserve pressure level. "%1" is replaced with the transceiver name.	The tank pressure value turns yellow. The paired watch vibrates and plays a warning tone.
%1 pressure is critically low.	Your tank pressure is below the critical pressure level. "%1" is replaced with the transceiver name.	The tank pressure value flashes red. The paired watch vibrates and plays a warning tone.
%1 has a low battery.	Fewer than 20 hours of dive time remain. "%1" is replaced with the transceiver name.	The transceiver name flashes BATT. LOW when the battery is critically low. The paired watch vibrates and plays a warning tone.
NO COMMS	Your paired watch has lost communication with the transceiver for 60 seconds.	The transceiver name flashes NO COMMS, dashed lines replace the tank pressure value, and the tank pressure value flashes red. The paired watch vibrates and plays a warning tone if connection alerts are enabled.
Transmitter %1 failed to connect.	Your paired watch cannot connect to the transceiver. You should update both devices to the latest software version. "%1" is replaced with the transceiver name.	The paired watch vibrates and plays a warning tone.









Enabling Lost Transceiver Alerts

Your paired watch can lose communication with the transceiver when the transceiver is out of range, when the transceiver signal is blocked by your body or that of another diver, and when the transceiver loses battery power. You can enable an alert that notifies you when your paired watch has lost communication with the transceiver for 60 seconds.

- 1 On the paired watch, hold **MENU**.
- 2 Select **Dive Setup > Dive Network & Air Integration > Connection Alert**.

Dive Product and Feature Compatibility

You can pair multiple Descent devices to form a dive network for you and your fellow divers.

	Descent T1 with 2.xx software or earlier	Descent T1 with 3.xx software or later	Descent T2
Descent Mk2i with 20.40 software or earlier	 <ul style="list-style-type: none"> View tank pressure View diver depth 	 <ul style="list-style-type: none"> No network connection 	 <ul style="list-style-type: none"> No network connection
Descent Mk2i with 22.00 software or later	 <ul style="list-style-type: none"> View tank pressure View diver depth 	 <ul style="list-style-type: none"> View tank pressure View diver depth View public tank name 	 <ul style="list-style-type: none"> View tank pressure View diver depth View public tank name
Descent Mk3i	 <ul style="list-style-type: none"> View tank pressure View diver depth 	 <ul style="list-style-type: none"> View tank pressure View diver depth View public tank name 	 <ul style="list-style-type: none"> View tank pressure View diver depth View public tank name

: View tank pressure for yourself and connected divers.

: View diver depth for connected divers.

: View the public transceiver names for yourself and connected divers.

: No dive network connection. You should update both of your devices to the latest software versions.

The following alert appears on the watch: Transmitter %1 failed to connect.. "%1" is replaced with the transceiver name.

Dive Terminology

Air time remaining (ATR): The time you may remain at the current depth until an ascent at 9 m/min. (30 ft./min.) would result in surfacing with the reserve pressure.

Central nervous system (CNS): A measure of central nervous system oxygen toxicity caused by exposure to increased partial pressure of oxygen (PO₂) while diving.

Closed-circuit rebreather (CCR): A diving mode used for dives performed with a rebreather that recirculates exhaled gas and removes carbon dioxide.

Maximum operating depth (MOD): The greatest depth at which a breathing gas can be used before the partial pressure of oxygen (PO₂) exceeds the safe limit.

No decompression limit (NDL): A dive that does not require decompression time while ascending to the surface.

Oxygen toxicity units (OTU): A measure of pulmonary oxygen toxicity caused by exposure to increased partial pressure of oxygen (PO₂) while diving. One OTU is equivalent to breathing 100% oxygen at 1 ATM for 1 minute.

Partial pressure of oxygen (PO₂): The pressure of the oxygen in the breathing gas, based on depth and oxygen percentage.

Pressure-based surface air consumption (PSAC): The change in pressure over time, normalized to 1 ATM.

Respiratory minute volume (RMV): The change in gas volume at ambient pressure over time.

Surface interval (SI): The amount of time that has elapsed since the completion of the last dive.

Time to surface (TTS): The estimated amount of time it will take to ascend to the surface, including decompression stops.

Volumetric surface air consumption (SAC): The change in gas volume over time, normalized to 1 ATM.

Clocks

Setting an Alarm

You can set multiple alarms.

- 1 From the watch face, hold **MENU**.
- 2 Select **Clocks > ALARMS > Add Alarm**.
- 3 Enter the alarm time.

Editing an Alarm

- 1 Hold **MENU**.
- 2 Select **Clocks > ALARMS > Edit**.
- 3 Select an alarm.
- 4 Select an option:
 - To turn the alarm on or off, select **Status**.
 - To change the alarm time, select **Time**.
 - To set the alarm to repeat regularly, select **Repeat**, and select when the alarm should repeat.
 - To select the type of alarm notification, select **Sound and Vibe**.
 - To select a description for the alarm, select **Label**.
 - To delete the alarm, select **Delete**.

Starting the Countdown Timer

- 1 From the watch face, hold **MENU**.
- 2 Select **Clocks > TIMERS**.
- 3 Select an option:
 - To set and save a countdown timer for the first time, enter the time, press **MENU**, and select **Save Timer**.
 - To set and save additional countdown timers, select **Add Timer**, and enter the time.
 - To set a countdown timer without saving it, select **Quick Timer**, and enter the time.
- 4 If necessary, press **MENU**, and select an option:
 - Select **Time** to change the time.
 - Select **Restart > On** to automatically restart the timer after it expires.
 - Select **Sound and Vibe**, and select a type of notification.
- 5 Press **START** to start the timer.

Deleting a Timer

- 1 From the watch face, hold **MENU**.
- 2 Select **Clocks > TIMERS > Edit**.
- 3 Select a timer.
- 4 Select **Delete**.

Using the Stopwatch

- 1 From the watch face, hold **MENU**.
- 2 Select **Clocks > STOPWATCH**.
- 3 Press **START** to start the timer.
- 4 Press **LAP** to restart the lap timer ①.



The total stopwatch time ② continues running.

- 5 Press **STOP** to stop both timers.
- 6 Select an option:
 - To reset both timers, press **DOWN**.
 - To save the stopwatch time as an activity, press **MENU**, and select **Save Activity**.
 - To reset the timers and exit the stopwatch, press **MENU**, and select **Done**.
 - To review the lap timers, press **MENU**, and select **Review**.
NOTE: The **Review** option only appears if there have been multiple laps.
 - To return to the watch face without resetting the timers, press **MENU**, and select **Go to Watchface**.
 - To enable or disable lap recording, press **MENU**, and select **Lap Key**.

Adding Alternate Time Zones

You can display the current time of day in additional time zones on the alternate time zones glance. You can add up to four alternate time zones.

NOTE: You may need to add the alternate time zones glance to the glance loop ([Customizing the Glance Loop, page 90](#)).

- 1 From the watch face, hold **MENU**.
- 2 Select **Clocks > ALT. TIME ZONES > Add Alt. Time Zone**.
- 3 Select a time zone.
- 4 If necessary, rename the zone.

Editing an Alternate Time Zone

- 1 Hold **MENU**.
- 2 Select **Clocks > ALT. TIME ZONES**.
- 3 Select a time zone.
- 4 Press **START**.
- 5 Select an option:
 - To set the time zone to display on the glance loop, select **Set as Favorite**.
 - To enter a custom name for the time zone, select **Rename Zone**.
 - To enter a custom abbreviation for the time zone, select **Abbreviate Zone**.
 - To change the time zone, select **Change Zone**.
 - To delete the time zone, select **Delete Zone**.

Activities and Apps

Your watch can be used for indoor, outdoor, athletic, and fitness activities. When you start an activity, the watch displays and records sensor data. You can create custom activities or new activities based on default activities ([Creating a Custom Activity, page 60](#)). When you finish your activities, you can save and share them with the Garmin Connect™ community.

You can also add Connect IQ™ activities and apps to your watch using the Connect IQ app ([Connect IQ Features, page 135](#)).

For more information about activity tracking and fitness metric accuracy, go to garmin.com/ataccuracy.

Starting an Activity

When you start an activity, GPS turns on automatically (if required).

- 1 From the watch face, press **START**.
- 2 If this is the first time you are starting an activity, select the checkbox next to each activity to add to your favorites, and select **Done**.
- 3 Select an option:
 - Select an activity from your favorites.
 - Select  and select an activity from the extended activity list.
- 4 If the activity requires GPS signals, go outside to an area with a clear view of the sky, and wait until the watch is ready.

The watch is ready after it establishes your heart rate, acquires GPS signals (if required), and connects to your wireless sensors (if required).
- 5 Press **START** to start the activity timer.

The watch records activity data only while the activity timer is running.

Tips for Recording Activities

- Charge the watch before starting an activity ([Charging the Watch, page 155](#)).
- Press **LAP** to record laps, start a new set or pose, or advance to the next workout step.
- Press **UP** or **DOWN** to view additional data screens.
- Swipe up or down to view additional data screens.
- Hold **MENU**, and select **Power Mode** to use a power mode to extend battery life ([Customizing Power Modes, page 151](#)).

Stopping an Activity

- 1 Press **STOP**.
 - 2 Select an option:
 - To resume your activity, select **Resume**.
 - To save the activity and view the details, select **Save**, press **START**, and select an option.
NOTE: After you save the activity, you can enter self-evaluation data ([Evaluating an Activity, page 33](#)).
 - To suspend your activity and resume it at a later time, select **Resume Later**.
 - To mark a lap, select **Lap**.
 - To navigate back to the starting point of your activity along the path you traveled, select **Back to Start > TracBack**.
NOTE: This feature is available only for activities that use GPS.
 - To navigate back to the starting point of your activity by the most direct path, select **Back to Start > Route**.
NOTE: This feature is available only for activities that use GPS.
 - To measure the difference between your heart rate at the end of the activity and your heart rate two minutes later, select **Recovery HR**, and wait while the timer counts down.
 - To discard the activity, select **Discard**.
- NOTE:** After stopping the activity, the watch saves it automatically after 30 minutes.

Evaluating an Activity

NOTE: This feature is not available for all activities.

You can customize the self-evaluation setting for certain activities ([Activities and App Settings, page 61](#)).

- 1 After you complete an activity, select **Save** ([Stopping an Activity, page 33](#)).
- 2 Select a number that corresponds with your perceived effort.
NOTE: You can select **»»** to skip the self evaluation.
- 3 Select how you felt during the activity.

You can view evaluations in the Garmin Connect app.

Running

Going for a Track Run

Before you go for a track run, make sure you are running on a standard-shape, 400 m track.

You can use the track run activity to record your outdoor track data, including distance in meters and lap splits.

- 1 Stand on the outdoor track.
- 2 From the watch face, press **START**.
- 3 Select **Track Run**.
- 4 Wait while the watch locates satellites.
- 5 If you are running in lane 1, skip to step 11.
- 6 Press **MENU**.
- 7 Select the activity settings.
- 8 Select **Lane Number**.
- 9 Select a lane number.
- 10 Press **BACK** twice to return to the activity timer.
- 11 Press **START**.
- 12 Run around the track.

After you run 3 laps, your watch records the track dimensions and calibrates your track distance.

- 13 After you complete your activity, press **STOP**, and select **Save**.

Tips for Recording a Track Run

- Wait until the GPS status indicator turns green before starting a track run.
- During your first run on an unfamiliar track, run for a minimum of 3 laps to calibrate your track distance. You should run slightly past your starting point to complete the lap.
- Run each lap in the same lane.
NOTE: The default Auto Lap® distance is 1600 m, or 4 laps around the track.
- If you are running in a lane other than lane 1, set the lane number in the activity settings.

Going for a Virtual Run

You can pair your watch with a compatible third-party app to transmit pace, heart rate, or cadence data.

- 1 From the watch face, press **START**.
- 2 Select **Virtual Run**.
- 3 On your tablet, laptop, or phone, open the Zwift™ app or another virtual training app.
- 4 Follow the on-screen instructions to start a running activity and pair the devices.
- 5 Press **START** to start the activity timer.
- 6 After you complete your activity, press **STOP**, and select **Save**.

Calibrating the Treadmill Distance

To record more accurate distances for your treadmill runs, you can calibrate the treadmill distance after you run at least 1.5 km (1 mi.) on a treadmill. If you use different treadmills, you can manually calibrate the treadmill distance on each treadmill or after each run.

- 1 Start a treadmill activity ([Starting an Activity, page 32](#)).
- 2 Run on the treadmill until your watch records at least 1.5 km (1 mi.).
- 3 After you finish the activity, press **STOP** to stop the activity timer.
- 4 Select an option:
 - To calibrate the treadmill distance the first time, select **Save**.
The device prompts you to complete the treadmill calibration.
 - To manually calibrate the treadmill distance after the first-time calibration, select **Calibrate & Save > Yes**.
- 5 Check the treadmill display for the distance traveled, and enter the distance on your watch.

Recording an Ultra Run Activity

- 1 From the watch face, press **START**.
- 2 Select **Ultra Run**.
- 3 Press **START** to start the activity timer.
- 4 Start running.
- 5 Press **LAP** to record a lap and start the rest timer.
NOTE: You can configure the Lap Key setting to record a lap and start the rest timer, start the rest timer only, or record a lap only ([Activities and App Settings, page 61](#)).
- 6 When you are done resting, press **LAP** to resume running.
- 7 Press **UP** or **DOWN** to view additional data pages (optional).
- 8 After you complete your activity, press **STOP**, and select **Save**.

Recording an Obstacle Racing Activity

When you participate in an obstacle course race, you can use the Obstacle Racing activity to record your time on each obstacle and your time running between obstacles.

- 1 From the watch face, press **START**.
- 2 Select **Obstacle Racing**.
- 3 Press **START** to start the activity timer.
- 4 Press **LAP** to manually mark the beginning and end of each obstacle.

NOTE: You can configure the Obstacle Tracking setting to save obstacle locations from your first loop of the course. On repeat loops of the course, the watch uses the saved locations to switch between obstacle and running intervals.

- 5 After you complete your activity, press **STOP**, and select **Save**.

Swimming

NOTE: The watch has wrist-based heart rate enabled for swim activities. The watch is also compatible with the HRM-Pro series, HRM-Swim™, and HRM-Tri™ accessories. If both wrist-based heart rate and chest heart rate data are available, your watch uses the chest heart rate data.

Swim Terminology

Length: One trip down the pool.

Interval: One or more consecutive lengths. A new interval starts after a rest.

Stroke: A stroke is counted every time your arm wearing the watch completes a full cycle.

Swolf: Your swolf score is the sum of the time for one pool length and the number of strokes for that length. For example, 30 seconds plus 15 strokes equals a swolf score of 45. For open water swimming, swolf is calculated over 25 meters. Swolf is a measurement of swimming efficiency and, like golf, a lower score is better.

Critical swim speed (CSS): Your CSS is the theoretical speed that you can maintain continuously without exhaustion. You can use your CSS to guide your training pace and monitor your improvement.

Stroke Types

Stroke type identification is available only for pool swimming. Your stroke type is identified at the end of a length. Stroke types appear in your swimming history and in your Garmin Connect account. You can also select stroke type as a custom data field ([Customizing the Data Screens, page 60](#)).

Free	Freestyle
Back	Backstroke
Breast	Breaststroke
Fly	Butterfly
Mixed	More than one stroke type in an interval
Drill	Used with drill logging (Training with the Drill Log, page 36)

Tips for Swimming Activities

- Press **LAP** to record an interval during open water swimming.
- Before starting a pool swimming activity, follow the on-screen instructions to select your pool size or enter a custom size.

The watch measures and records distance by completed pool lengths. The pool size must be correct to display accurate distance. The next time you start a pool swimming activity, the watch uses this pool size. You can hold **MENU**, select the activity settings, and select **Pool Size** to change the size.
- For accurate results, swim the entire pool length, and use one stroke type for the entire length. Pause the activity timer when resting.
- Press **LAP** to record a rest during pool swimming (*Auto Rest and Manual Rest, page 36*).

The watch automatically records swim intervals and lengths for pool swimming.
- To help the watch count your lengths, use a strong push off the wall and glide before your first stroke.
- When doing drills, you must either pause the activity timer or use the drill logging feature (*Training with the Drill Log, page 36*).

Auto Rest and Manual Rest

NOTE: Swim data is not recorded during a rest. To view other data screens, you can press UP or DOWN.

The auto rest feature is available only for pool swimming. Your watch automatically detects when you are resting, and the rest screen appears. If you rest for more than 15 seconds, the watch automatically creates a rest interval. When you resume swimming, the watch automatically starts a new swim interval. You can turn on the auto rest feature in the activity options (*Activities and App Settings, page 61*).

TIP: For best results using the auto rest feature, minimize your arm motions while resting.

During a pool or open water swim activity, you can manually mark a rest interval by pressing LAP.

Training with the Drill Log

The drill log feature is available only for pool swimming. You can use the drill log feature to manually record kick sets, one-arm swimming, or any type of swimming that is not one of the four major strokes.

- 1 During your pool swim activity, press **UP** or **DOWN** to view the drill log screen.
- 2 Press **LAP** to start the drill timer.
- 3 After you complete a drill interval, press **LAP**.

The drill timer stops, but the activity timer continues to record the entire swim session.
- 4 Select a distance for the completed drill.

Distance increments are based on the pool size selected for the activity profile.
- 5 Select an option:
 - To start another drill interval, press **LAP**.
 - To start a swim interval, press **UP** or **DOWN** to return to the swim training screens.

Multisport

Triathletes, duathletes, and other multisport competitors can take advantage of the multisport activities, such as Triathlon or Swimrun. During a multisport activity, you can transition between activities and continue to view your total time. For example, you can switch from biking to running and view your total time for biking and running throughout the multisport activity.

You can customize a multisport activity, or you can use the default triathlon activity set up for a standard triathlon.

Triathlon Training

When you participate in a triathlon, you can use the triathlon activity to quickly transition to each sport segment, to time each segment, and to save the activity.

- 1 From the watch face, press **START**.
- 2 Select **Triathlon**.
- 3 Press **START** to start the activity timer.
- 4 Press **LAP** at the beginning and end of each transition.
The transition feature is on by default, and the transition time is recorded separately from the activity time. The transition feature can be turned on or off in the triathlon activity settings. If transitions are turned off, press LAP to change sports.
- 5 After you complete your activity, press **STOP**, and select **Save**.

Creating a Multisport Activity

- 1 From the watch face, press **START**.
- 2 Select **Add > Multisport**.
- 3 Select a multisport activity type, or enter a custom name.
Duplicate activity names include a number. For example, Triathlon(2).
- 4 Select two or more activities.
- 5 Select an option:
 - Select an option to customize specific activity settings. For example, you can select whether to include transitions.
 - Select **Done** to save and use the multisport activity.
- 6 Select **Yes** to add the activity to your list of favorites.

Indoor Activities

The watch can be used for training indoors, such as running on an indoor track or using a stationary bike or indoor trainer. GPS is turned off for indoor activities ([Activities and App Settings, page 61](#)).

When running or walking with GPS turned off, speed and distance are calculated using the accelerometer in the watch. The accelerometer is self-calibrating. The accuracy of the speed and distance data improves after a few outdoor runs or walks using GPS.

TIP: Holding the handrails of the treadmill reduces accuracy.

When cycling with GPS turned off, speed and distance data are not available unless you have an optional sensor that sends speed and distance data to the watch, such as a speed or cadence sensor.

Health Snapshot™

The Health Snapshot feature records several key health metrics while you hold still for two minutes. It provides a glimpse of your overall cardiovascular status. The watch records metrics such as your average heart rate, stress level, and respiration rate. You can add the Health Snapshot feature to the list of your favorite apps ([Activities and App Settings, page 61](#)).

Recording a Strength Training Activity

You can record sets during a strength training activity. A set is multiple repetitions (reps) of a single move.

1 From the watch face, press **START**.

2 Select **Strength**.

3 Select a workout.

4 Press **DOWN** to view a list of workout steps (optional).

TIP: While viewing workout steps, you can press **START** and then press **DOWN** to view an animation of the selected exercise, if available.

5 When you have finished viewing the workout steps, press **START**, and select **Do Workout**.

6 Press **START**, and select **Start Workout**.

7 Start your first set.

The watch counts your reps. Your rep count appears when you complete at least four reps.

TIP: The watch can only count reps of a single move for each set. When you want to change moves, you should finish the set and start a new one.

8 Press **LAP** to finish the set and move to the next exercise, if available.

The watch displays the total reps for the set.

9 If necessary, press **UP** or **DOWN** to edit the number of reps.

TIP: You can also add the weight used for the set.

10 If necessary, press **LAP** when you are done resting to start your next set.

11 Repeat for each strength training set until your activity is complete.

12 After your last set, press **START**, and select **Stop Workout**.

13 Select **Save**.

Recording a HIIT Activity

You can use specialized timers to record a high-intensity interval training (HIIT) activity.

1 From the watch face, press **START**.

2 Select **HIIT**.

3 Select an option:

- Select **Free** to record an open, unstructured HIIT activity.
- Select **HIIT Timers > AMRAP** to record as many rounds as possible during a set time period.
- Select **HIIT Timers > EMOM** to record a set number of moves every minute on the minute.
- Select **HIIT Timers > Tabata** to alternate between 20-second intervals of maximum effort with 10 seconds of rest.
- Select **HIIT Timers > Custom** to set your move time, rest time, number of moves, and number of rounds.
- Select **Workouts** to follow a saved workout.

4 If necessary, follow the on-screen instructions.

5 Press **START** to start your first round.

The watch displays a countdown timer and your current heart rate.

6 If necessary, press **LAP** to manually move to the next round or rest.

7 After you finish the activity, press **STOP** to stop the activity timer.

8 Select **Save**.

Using an Indoor Trainer

Before you can use a compatible indoor trainer, you must pair the trainer with your watch using ANT+® technology (*Pairing Your Wireless Sensors, page 120*).

You can use your watch with an indoor trainer to simulate resistance while following a course, ride, or workout. While using an indoor trainer, GPS is turned off automatically.

- 1 From the watch face, press **START**.
- 2 Select **Bike Indoor**.
- 3 Hold **MENU**.
- 4 Select **Smart Trainer Options**.
- 5 Select an option:
 - Select **Free Ride** to go for a ride.
 - Select **Follow Workout** to follow a saved workout (*Workouts, page 75*).
 - Select **Follow Course** to follow a saved course (*Courses, page 147*).
 - Select **Set Power** to set the target power value.
 - Select **Set Grade** to set the simulated grade value.
 - Select **Set Resistance** to set the resistance force applied by the trainer.
- 6 Press **START** to start the activity timer.

The trainer increases or decreases resistance based on the elevation information in the course or ride.

Gaming

Using the Garmin GameOn™ App

When you pair your watch with your computer, you can record a gaming activity on your watch and view real-time performance metrics on your computer.

- 1 On your computer, go to www.overwolf.com/app/Garmin-Garmin_GameOn and download the Garmin GameOn app.
- 2 Follow the on-screen instructions to complete the installation.
- 3 Launch the Garmin GameOn app.
- 4 When the Garmin GameOn app prompts you to pair your watch, press **START**, and select **Gaming** on your watch.

NOTE: While your watch is connected to the Garmin GameOn app, notifications and other Bluetooth features are disabled on the watch.
- 5 Select **Pair Now**.
- 6 Select your watch from the list, and follow the on-screen instructions.

TIP: You can click  > **Settings** to customize your settings, reread the tutorial, or remove a watch. The Garmin GameOn app remembers your watch and settings the next time you open the app. If necessary, you can pair your watch to another computer (*Pairing Your Wireless Sensors, page 120*).
- 7 Select an option:
 - On your computer, start a supported game to automatically start the gaming activity.
 - On your watch, start a manual gaming activity (*Recording a Manual Gaming Activity, page 40*).

The Garmin GameOn app shows your real-time performance metrics. When you complete your activity, the Garmin GameOn app displays your gaming activity summary and match information.

Recording a Manual Gaming Activity

You can record a gaming activity on your watch and manually enter stats for each match.

- 1 From the watch face, press **START**.
- 2 Select **Gaming**.
- 3 Press **DOWN**, and select a game type.
- 4 Press **START** to start the activity timer.
- 5 Press **LAP** at the end of the match to record your match result or placement.
- 6 Press **LAP** to start a new match.
- 7 After you complete your activity, press **STOP**, and select **Save**.

Climbing Sports

Recording an Indoor Climbing Activity

You can record routes during an indoor climbing activity. A route is a climbing path along an indoor rock wall.

- 1 From the watch face, press **START**.
- 2 Select **Climb Indoor**.
- 3 Select **Yes** to record route statistics.
- 4 Select a grading system.
NOTE: The next time you start an indoor climbing activity, the device uses this grading system. You can hold **MENU**, select the activity settings, and select Grading System to change the system.
- 5 Select the difficulty level for the route.
- 6 Press **START**.
- 7 Start your first route.
NOTE: When the route timer is running, the device automatically locks the buttons to prevent accidental button presses. You can hold any button to unlock the watch.
- 8 When you finish the route, descend to the ground.
The rest timer starts automatically when you are on the ground.
NOTE: If necessary, you can press **LAP** to finish the route.
- 9 Select an option:
 - To save a successful route, select **Completed**.
 - To save an unsuccessful route, select **Attempted**.
 - To delete the route, select **Discard**.
- 10 Enter the number of falls for the route.
- 11 When you are done resting, press **LAP** and begin your next route.
- 12 Repeat this process for each route until your activity is complete.
- 13 Press **STOP**.
- 14 Select **Save**.

Recording a Bouldering Activity

You can record routes during a bouldering activity. A route is a climbing path along a boulder or small rock formation.

- 1 From the watch face, press **START**.
- 2 Select **Bouldering**.
- 3 Select a grading system.
NOTE: The next time you start a bouldering activity, the watch uses this grading system. You can hold **MENU**, select the activity settings, and select Grading System to change the system.
- 4 Select the difficulty level for the route.
- 5 Press **START** to start the route timer.
- 6 Start your first route.
- 7 Press **LAP** to finish the route.
- 8 Select an option:
 - To save a successful route, select **Completed**.
 - To save an unsuccessful route, select **Attempted**.
 - To delete the route, select **Discard**.
- 9 When you are done resting, press **LAP** to start your next route.
- 10 Repeat this process for each route until your activity is complete.
- 11 After your last route, press **STOP** to stop the route timer.
- 12 Select **Save**.

Starting an Expedition

You can use the **Expedition** app to prolong the battery life while recording a multi-day activity.

- 1 From the watch face, press **START**.
- 2 Select **Expedition**.
- 3 Press **START** to start the activity timer.
The device enters low power mode and collects GPS track points once an hour. To maximize battery life, the device turns off all sensors and accessories, including the connection to your smartphone.

Recording a Track Point Manually

During an expedition, track points are recorded automatically based on the selected recording interval. You can manually record a track point at any time.

- 1 During an expedition, press **START**.
- 2 Select **Add Point**.

Viewing Track Points

- 1 During an expedition, press **START**.
- 2 Select **View Points**.
- 3 Select a track point from the list.
- 4 Select an option:
 - To start navigating to the track point, select **Go To**.
 - To view detailed information about the track point, select **Details**.

Going Hunting

You can save locations relevant to your hunt and view a map of saved locations. During a hunting activity, the device uses a GNSS mode that conserves battery life.

- 1 From the watch face, press **START**.
- 2 Select **Hunt**.
- 3 Press **START**, and select **Start Hunt**.
- 4 Press **START**, and select an option:
 - To navigate back to the starting point of your activity, select **Back to Start**, and select an option.
 - To save your current location, select **Save Location**.
 - To view locations saved during this hunt activity, select **Hunt Locations**.
 - To view all previously saved locations, select **Saved Locations**.
 - To navigate to a destination, select **Navigation**, and select an option.
- 5 After you complete your hunt, press **STOP**, and select **End Hunt**.

Marine Activities

Sailing

Tack Assist

⚠ CAUTION

The watch uses GPS-based course over ground to determine your course in the tack assist feature, and does not account for other factors that can affect your boat's direction, such as currents and tides. You are responsible for the safe and prudent operation of your vessel.

While cruising or racing into the wind, the tack assist feature can help you determine if your boat is being lifted or headed. When you calibrate tack assist, the watch captures your boat's port **①** and starboard **②** course over ground (COG) measurements, and uses the COG data to calculate the mean true wind direction **③** and the boat's tack angle **④**.

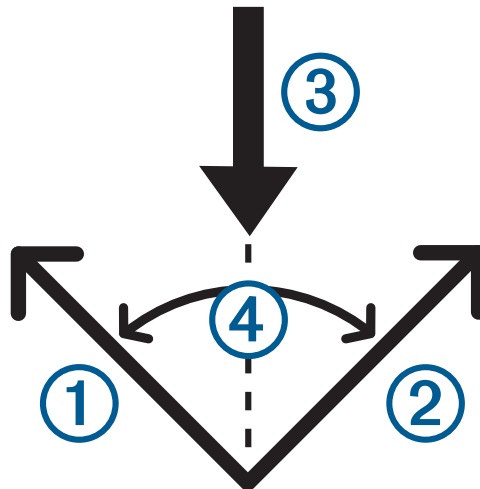

The watch uses this data to determine whether your boat is being lifted or headed due to wind shifts.

By default, the tack assist feature is set to automatic. Each time you calibrate the port or starboard COG, the watch recalibrates the opposite side and true wind direction. You can change the tack assist settings to enter a fixed tack angle or true wind direction.

Calibrating the Tack Assist

- 1 From the watch face, select **START**.
- 2 Select **Sail Race** or **Sail**.
- 3 Select **UP** or **DOWN** to view the tack assist screen.

NOTE: You may need to add the tack assist screen to the data screens for the activity ([Customizing the Data Screens, page 60](#)).

- 4 Select **START**.
- 5 Select an option:
 - To calibrate the starboard side, select **START**.
 - To calibrate the port side, select **DOWN**.

TIP: If the wind is coming from the starboard side of the vessel, you should calibrate starboard. If the wind is coming from the port side of the vessel, you should calibrate port.

- 6 Wait while the device calibrates the tack assist.
An arrow appears and indicates if your boat is being lifted or headed.

Entering a Fixed Tack Angle

- 1 From the watch face, press **START**.
- 2 Select **Sail Race** or **Sail**.
- 3 Press **UP** or **DOWN** to view the tack assist screen.
- 4 Hold **MENU**.
- 5 Select **Tack Angle > Angle**.
- 6 Press **UP** or **DOWN** to set the value.

Entering a True Wind Direction

- 1 From the watch face, press **START**.
- 2 Select **Sail Race** or **Sail**.
- 3 Press **UP** or **DOWN** to view the tack assist screen.
- 4 Hold **MENU**.
- 5 Select **True Wind Direction > Fixed**.
- 6 Press **UP** or **DOWN** to set the value.

Tips for Getting the Best Lift Estimate

To get the best lift estimate when using the tack assist feature, you can try these tips. See [Entering a True Wind Direction, page 43](#) and [Calibrating the Tack Assist, page 43](#) for more information.

- Enter a fixed tack angle, and calibrate the port side.
- Enter a fixed tack angle, and calibrate the starboard side.
- Reset the tack angle, and calibrate both the port and starboard side.

Sail Racing

You can use the device to help you cross the start line of a race exactly when the race begins. When you synchronize the regatta timer in the sail racing app with the official race countdown timer, you are alerted at one-minute intervals as the race start approaches. When you set the starting line, the device uses GPS data to indicate whether your boat will cross the start line before, after, or at the correct time to start the race.

Setting the Starting Line

- 1 From the watch face, press **START**.
- 2 Select **Sail Race**.
- 3 Wait while the device locates satellites.
- 4 Hold **MENU**.
- 5 Select **Start Line Settings**.
- 6 Select an option:
 - Select **Mark Port** to mark the port starting line mark as you sail past it.
 - Select **Mark Starboard** to mark the starboard starting line mark as you sail past it.
 - Select **Time to Burn** to enable or disable the time to burn data on the regatta timer data screen.
 - Select **Distance to Start** to set the distance to the start line, preferred distance units, and length of your boat.

Starting a Race

Before you can view the time to burn, you must set the starting line ([Setting the Starting Line, page 44](#)).

- 1 From the watch face, press **START**.
- 2 Select **Sail Race**.
- 3 Wait while the watch locates satellites.
The screen displays the regatta timer ① and time to burn ②.

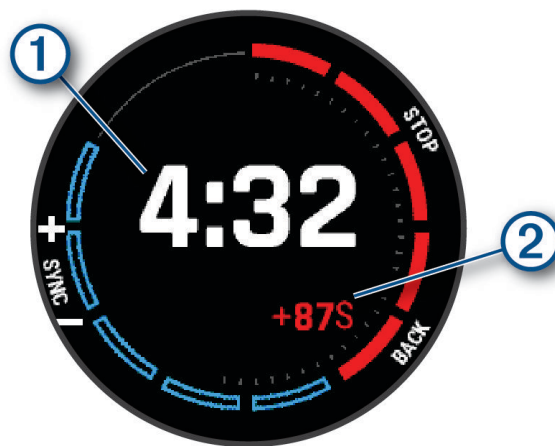

- 4 If necessary, hold **MENU**, and select an option:
 - To set a fixed timer, select **Regatta Time > Fixed**, and enter a length of time.
 - To set a start time within the next 24 hours, select **Regatta Time > GPS**, and enter a time of day.
- 5 Press **START**.
- 6 Press **UP** and **DOWN** to synchronize the regatta timer with the official race countdown.
NOTE: When the burn time is negative, you will arrive at the start line after the race starts. When the burn time is positive, you will arrive at the start line before the race starts.
- 7 Press **START** to start the activity timer.

Water Sports

Viewing Your Water Sport Runs

Your watch records the details of each water sport run using the auto run feature. This feature automatically records new runs based on your movement. The activity timer pauses when you stop moving. The activity timer starts automatically when your movement speed increases. You can view run details from the paused screen or while the activity timer is running.

- 1 Start a water sport activity, such as water skiing.
- 2 Hold **MENU**.
- 3 Select **View Runs**.
- 4 Press **UP** and **DOWN** to view details of your last run, your current run, and your total runs.
The run screens include time, distance traveled, maximum speed, and average speed.

Fishing

Going Fishing

- 1 From the watch face, press **START**.
- 2 Select **Fish**.
- 3 Press **START** > **Start Fish**.
- 4 Press **START**, and select an option:
 - To add the catch to your fish count and save the location, select **Log Catch**.
 - To save your current location, select **Save Location**.
 - To set an interval timer, end time, or end time reminder for the activity, select **Fish Timers**.
 - To navigate back to the starting point of your activity, select **Back to Start**, and select an option.
 - To view your saved locations, select **Saved Locations**.
 - To navigate to a destination, select **Navigation**, and select an option.
 - To edit the activity settings, select **Settings**, and select an option ([Activities and App Settings, page 61](#)).
- 5 After you complete your activity, press **STOP**, and select **End Fish**.

Tides

Viewing Tide Information

WARNING

Tide information is for information purposes only. It is your responsibility to heed all posted water-related guidance, to remain aware of your surroundings, and to use safe judgment in, on, and around the water at all times. Failure to heed this warning could result in serious personal injury or death.

You can view information about a tide station, including the tide height and when the next high and low tides will occur. You can save up to ten tide stations.

- 1 From the watch face, press **START**.
- 2 Select **Tides**.

3 Select an option:

- To use your current location when you are near a tide station, select **Add > Current Location**.
- To select a location on the map, select **Add > Use Map**.
- To enter the name of a city, select **Add > City Search**.
- To select a saved location, select **Add > Saved Locations**.
- To enter coordinates for a location, select **Add > Coordinates**.

A 24-hour tide chart appears for the current date with the current tide height ① and information about the next high and low tides ②.

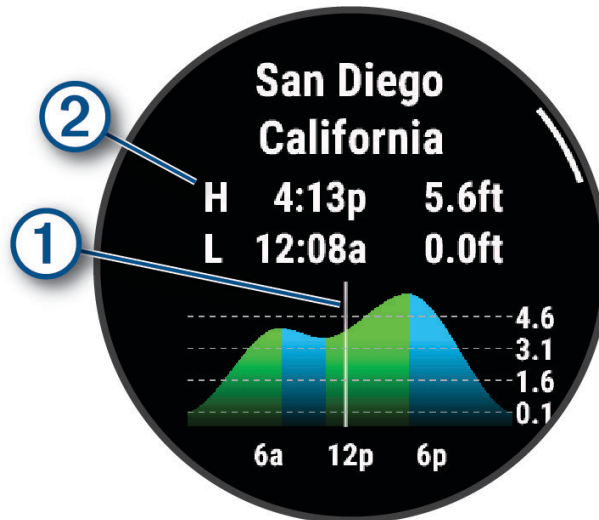

4 Press **DOWN** to see tide information for upcoming days.

5 Press **START**, and select **Set as Favorite** to set this location as your favorite tide station.
Your favorite tide station appears at the top of the list in the app and in the glance.

Setting a Tide Alert

1 From the **Tides** app, select a saved tide station.

2 Press **START**, and select **Set Alerts**.

3 Select an option:

- To set an alarm to sound before the peak tide, select **Til High Tide**.
- To set an alarm to sound before the low tide, select **Til Low Tide**.

Anchor

⚠ WARNING

The anchor feature is a tool for situational awareness only and may not prevent groundings or collisions in all circumstances. You are responsible for the safe and prudent operation of your vessel, for remaining aware of your surroundings, and for using safe judgment on the water at all times. Failure to heed this warning could result in property damage, serious personal injury, or death.

Marking Your Anchor Location

1 From the watch face, press **START**.

2 Select **Anchor**.

3 Wait while the watch locates satellites.

4 Press **START**, and select **Drop Anchor**.

Anchor Settings

From the watch face, press **START**, select **Anchor**, hold **MENU**, and select the activity settings.

Drift Radius: Sets the allowable drift distance while anchored.

Update Interval: Sets the time interval for updating anchor data.





Anchor Alarm: Allows you to enable or disable an alarm for when the boat moves beyond the drift radius.

Anchor Alarm Duration: Allows you to set the anchor alarm duration. When the anchor alarm is enabled, an alert appears each time the boat moves beyond the drift radius during the specified alarm duration.

Trolling Motor Remote

Pairing Your Watch and Trolling Motor

You can pair your watch with a Garmin trolling motor and use it as a remote control. For more information about using a remote control, see your trolling motor owner's manual.

- 1 Turn on the trolling motor.
- 2 Bring the watch within 1 m (3 ft.) of the display panel on the trolling motor.
- 3 On the watch, press **START**, and select **Trolling Motor**.
TIP: If necessary, you can pair your watch with another trolling motor ([Pairing Your Wireless Sensors, page 120](#)).
- 4 On the trolling motor display panel, press  three times to enter pairing mode.
 on the trolling motor display panel illuminates blue as it searches for a connection.
- 5 On the watch, press **START** to enter pairing mode.
- 6 Verify that the passkey shown on your trolling motor remote control matches your watch.
- 7 On the watch, press **START** to confirm the passkey.
- 8 On the trolling motor remote control, press  to confirm the passkey.
 on the trolling motor display panel illuminates green when the connection to your watch is successful.

Skiing and Winter Sports

You can add skiing and snowboarding activities to your activity list ([Customizing Activities and Apps, page 59](#)). You can customize the data screens for each activity ([Customizing the Data Screens, page 60](#)).

Viewing Your Ski Runs

Your watch records the details of each downhill skiing or snowboarding run using the auto run feature. This feature is turned on by default for downhill skiing and snowboarding. It automatically records new ski runs when you start moving down hill.

- 1 Start a skiing or snowboarding activity.
- 2 Hold **MENU**.
- 3 Select **View Runs**.
- 4 Press **UP** and **DOWN** to view details of your last run, your current run, and your total runs.
The run screens include time, distance traveled, maximum speed, average speed, and total descent.

Recording a Backcountry Skiing or Snowboarding Activity

The backcountry skiing or snowboarding activity lets you switch between climbing and descending tracking modes so you can accurately track your statistics. You can customize the Mode Tracking setting to automatically or manually switch tracking modes ([Activities and App Settings, page 61](#)).

- 1 From the watch face, press **START**.
- 2 Select **Backcountry Ski** or **Backcountry Snowboard**.
- 3 Select an option:
 - If you are starting your activity on a climb, select **Climbing**.
 - If you are starting your activity moving downhill, select **Descending**.
- 4 Press **START** to start the activity timer.
- 5 If necessary, press **LAP** to switch between climbing and descending tracking modes.
- 6 After you complete your activity, press **STOP**, and select **Save**.

Cross-Country Skiing Power Data

NOTE: The HRM-Pro series accessory must be paired to the Descent watch using ANT+ technology.

You can use your compatible Descent watch paired with the HRM-Pro series accessory to provide real-time feedback about your cross-country skiing performance. The power output is measured in watts. Factors that affect power include your speed, elevation changes, wind, and snow conditions. You can use power output to measure and improve your skiing performance.

NOTE: Skiing power values are generally lower than cycling power values. This is normal and occurs because humans are less efficient at skiing than they are at cycling. It is common for ski power values to be 30 to 40 percent lower than cycling power values at the same training intensity.

Golfing

Playing Golf

Before you play golf, you should charge the watch ([Charging the Watch, page 155](#)).

- 1 From the watch face, press **START**.
- 2 Select **Golf**.
The device locates satellites, calculates your location, and selects a course if there is only one course nearby.
- 3 If the course list appears, select a course from the list.
- 4 If necessary, set your driver distance.
- 5 Select  to keep score.

6 Select a tee box.

The hole information screen appears.

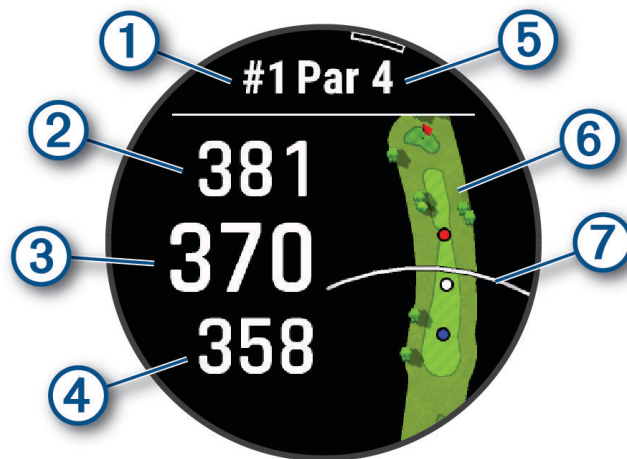

①	Current hole number
②	Distance to the back of the green
③	Distance to the middle of the green
④	Distance to the front of the green
⑤	Par for the hole
⑥	Map of the green
⑦	Driver distance from the tee box

NOTE: Because pin locations change, the watch calculates the distance to the front, middle, and back of the green, but not the actual pin location.

7 Select an option:

- Tap the front, middle, or back distances to the green to view the PlaysLike distance ([PlaysLike Distance Icons](#), page 52).
- Tap the map to view more detail or measure distance with touch targeting ([Measuring Distance with Touch Targeting](#), page 53).
- Press **UP** or **DOWN** to view the location and distance to a layup or to the front and back of a hazard.
- Press **START** to open the golf menu ([Golf Menu](#), page 51).

When you move to the next hole, the watch automatically transitions to display the new hole information.

Golf Menu

During a round, you can press **START** to access additional features in the golf menu.

End Round: Ends the current round.

Change Hole: Allows you to manually change the hole.

Change Green: Allows you to change the green when more than one green is available for a hole.

View Green: Allows you to move the pin location to get a more precise distance measurement ([Moving the Flag, page 51](#)).

Virtual Caddie: Requests a club recommendation from the virtual caddie ([Virtual Caddie, page 52](#)).

PlaysLike: Shows the PlaysLike factors for the hole ([PlaysLike Distance Icons, page 52](#)).

Measure Shot: Shows the distance of your previous shot recorded with the Garmin AutoShot™ feature ([Viewing Measured Shots, page 53](#)). You can also manually record a shot ([Manually Measuring a Shot, page 53](#)).

Scorecard: Opens the scorecard for the round ([Keeping Score, page 53](#)).

Odometer: Shows the recorded time, distance, and steps traveled. The odometer automatically starts and stops when you start or end a round. You can reset the odometer during a round.

Wind: Opens a pointer that shows the wind direction and speed relative to the pin ([Viewing the Wind Speed and Direction, page 54](#)).

PinPointer: The PinPointer feature is a compass that points to the pin location when you are unable to see the green. This feature can help you line up a shot even if you are in the woods or in a deep sand trap.

NOTE: Do not use the PinPointer feature while in a golf cart. Interference from the golf cart can affect the accuracy of the compass.

Custom Targets: Allows you to save a location, such as an object or obstacle, for the current hole ([Saving Custom Targets, page 55](#)).

Club Stats: Shows your statistics with each golf club, such as distance and accuracy information. Appears when you pair Approach® CT10 sensors or enable the Club Prompt setting.

Sunrise & Sunset: Shows the sunrise, sunset, and twilight times for the current day.

Settings: Allows you to customize the golf activity settings ([Activities and App Settings, page 61](#)).

Moving the Flag

You can take a closer look at the green and move the pin location.

1 From the hole information screen, press **START**.

2 Select **View Green**.

3 Tap or drag  to move the pin location.

TIP: You can press **START** to zoom in our out.

4 Press **BACK**.

The distances on the hole information screen are updated to show the new pin location. The pin location is saved for only the current round.

Virtual Caddie

Before you can use the virtual caddie, you must play five rounds with Approach CT10 sensors or enable the Club Prompt setting ([Activities and App Settings, page 61](#)), and upload your scorecards. For each round, you must connect to a paired phone with the Garmin Golf™ app. The virtual caddie provides recommendations based on the hole, wind data, and your past performance with each club.

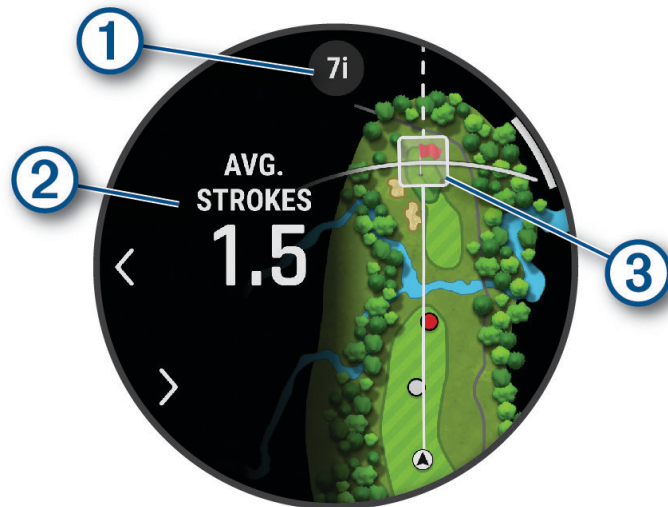

① Displays the club or club combination recommendation for the hole. You can select < or > to view other club options.

② Displays the average number of strokes expected to score with the club recommendation.

③ Displays the shot dispersion area for your next shot with the club recommendation, based on your shot history with the club.
NOTE: If the shot dispersion area overlaps with the green, the shot's chances of reaching the green will display as a percentage.

PlaysLike Distance Icons

The PlaysLike distance feature accounts for elevation changes on the course, wind speed, wind direction, and air density by showing the adjusted distance to the green ([PlaysLike Distance Factors, page 52](#)). During a round, you can tap a distance to the green to view the PlaysLike distance.

TIP: You can configure what data is factored into the PlaysLike adjustments in the activity settings ([PlaysLike Settings, page 53](#)).

▲: Distance plays longer than expected.

■: Distance plays as expected.

▼: Distance plays shorter than expected.

PlaysLike Distance Factors

During a round of golf, you can view how much of the PlaysLike distance adjustments are due to elevation changes on the course, wind speed and direction, and air density.

Press START, and select PlaysLike.

▲: The difference in the distance due to elevation changes.

▲: The difference in the distance due to the wind speed and direction.

☁: The difference in the distance due to the air density.

PlaysLike Settings

Hold MENU, and select **Activities & Apps > Golf > Golf Settings > PlaysLike**.

Wind: Enables wind speed and direction to be included in the PlaysLike distance adjustments.



Weather: Enables air density to be included in the PlaysLike distance adjustments.

Home Conditions: Allows you to manually change the altitude, temperature, and humidity settings used for the air density.

NOTE: It can be helpful to set weather conditions that match where you typically play. If they do not match the conditions at your normal course locations, the air density adjustments may seem inaccurate.

Measuring Distance with Touch Targeting

While playing a game, you can use touch targeting to measure the distance to any point on the map.

- 1 While playing golf, tap the map.
- 2 Tap or drag your finger to position the target circle .
You can view the distance from your current position to the target circle, and from the target circle to the pin location.
- 3 If necessary, select  or  to zoom in or out.

Viewing Measured Shots

Your device features automatic shot detection and recording. Each time you take a shot along the fairway, the device records your shot distance so you can view it later.

TIP: Automatic shot detection works best when you wear the device on your leading wrist and make good contact with the ball. Putts are not detected.

- 1 While playing golf, press **START**.
- 2 Select **Previous Shots** to view all recorded shot distances.

NOTE: The distance from the most recent shot also displays at the top of the hole information screen.

Manually Measuring a Shot

You can manually add a shot if the watch doesn't detect it. You must add the shot from the location of the missed shot.

- 1 Take a shot and watch where your ball lands.
- 2 From the hole information screen, press **START**.
- 3 Select **Measure Shot**.
- 4 Press **START**.
- 5 Select **Add Shot > ✓**.
- 6 If necessary, enter the club you used for the shot.
- 7 Walk or drive to your ball.

The next time you take a shot, the watch automatically records your last shot distance. If necessary, you can manually add another shot.

Keeping Score

- 1 From the hole information screen, press **START**.
- 2 Select **Scorecard**.
The scorecard appears when you are on the green.
- 3 Press **UP** or **DOWN** to scroll through the holes.
- 4 Press **START** to select a hole.
- 5 Press **UP** or **DOWN** to set the score.
Your total score is updated.

Recording Statistics

Before you can record statistics, you must enable statistics tracking ([Scoring Settings, page 54](#)).

- 1 From the scorecard, select a hole.
- 2 Enter the total number of strokes taken, including putts, and press **START**.
- 3 Set the number of putts taken, and press **START**.
NOTE: The number of putts taken is used for statistics tracking only and does not increase your score.
- 4 If necessary, select an option:
NOTE: If you are on a par 3 hole, fairway information does not appear.
 - If your ball hit the fairway, select **In Fairway**.
 - If your ball missed the fairway, select **Missed Right** or **Missed Left**.
- 5 If necessary, enter the number of penalty strokes.

Scoring Settings

Hold MENU, and select **Activities & Apps > Golf > Golf Settings > Scoring**.

Scoring Method: Changes the method the device uses to keep score.

Handicap Scoring: Enables handicap scoring.

Set Handicap: Sets your handicap when handicap scoring is enabled.

Show Score: Displays your total score for the round at the top of the scorecard ([Keeping Score, page 53](#)).

Stat Tracking: Enables statistics tracking for the number of putts, greens in regulation, and fairways hit while playing golf.

Penalties: Enables penalty stroke tracking while playing golf ([Recording Statistics, page 54](#)).

Prompt: Enables the prompt at the start of a round asking if you want to keep score.

About Stableford Scoring

When you select the Stableford scoring method ([Activities and App Settings, page 61](#)), points are awarded based on the number of strokes taken relative to par. At the end of a round, the highest score wins. The device awards points as specified by the United States Golf Association.

The scorecard for a Stableford scored game shows points instead of strokes.

Points	Strokes Taken Relative to Par
0	2 or more over
1	1 over
2	Par
3	1 under
4	2 under
5	3 under

Viewing the Wind Speed and Direction

The wind feature is a pointer that shows the wind speed and direction relative to the pin. The wind feature requires a connection with the Garmin Golf app.

- 1 Press **START**.
- 2 Select **Wind**.
The arrow points to the wind direction relative to the pin.

Viewing the Direction to the Pin

The PinPointer feature is a compass that provides directional assistance when you are unable to see the green. This feature can help you line up a shot even if you are in the woods or in a deep sand trap.

NOTE: Do not use the PinPointer feature while in a golf cart. Interference from the golf cart can affect the accuracy of the compass.

- 1 From the hole information screen, press **START**.
- 2 Select **PinPointer**.
The arrow points to the pin location.

Saving Custom Targets

While playing a round, you can save up to five custom targets for each hole. Saving a target is useful for recording objects or obstacles that are not shown on the map. You can view the distances to these targets from the hazards and layups screen (*Playing Golf*, page 49).

- 1 Stand near the target you want to save.
NOTE: You cannot save a target that is far from the currently selected hole.
- 2 From the hole information screen, press **START**.
- 3 Select **Custom Targets**.
- 4 Select a target type.

Big Numbers Mode

You can change the size of the numbers on the hole information screen. Hold **MENU**, select the activity settings, and select **Big Numbers**.

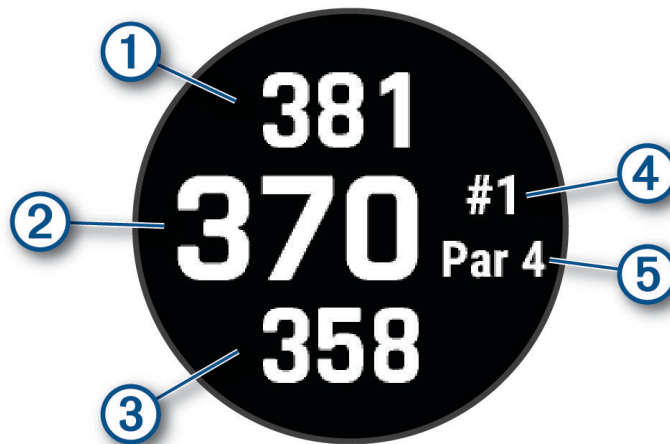

①	The distance to the back of the green
②	The distance to the middle of the green or selected pin position
③	The distance to the front of the green
④	The current hole number
⑤	The par for the current hole

Swing Tempo Training

The Tempo Training activity helps you perform a more consistent swing. The device measures and displays your backswing time and downswing time. The device also displays your swing tempo. Swing tempo is the backswing time divided by the downswing time, expressed in a ratio. A 3 to 1 ratio, or 3.0, is the ideal swing tempo based on studies of professional golfers.

The Ideal Swing Tempo

You can achieve the ideal 3.0 tempo using different swing timings, for example, 0.7 sec./0.23 sec. or 1.2 sec./0.4 sec. Each golfer may have a unique swing tempo based on their ability and experience. Garmin provides six different timings.

The device displays a graph that indicates if your backswing or downswing times are too fast, too slow, or just right for the selected timing.

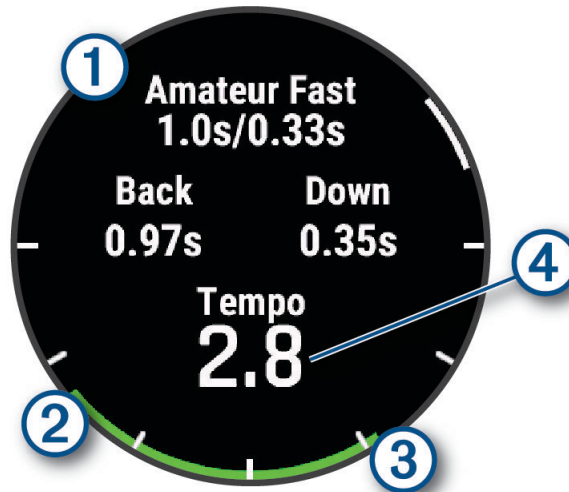

①	Timing choices (backswing to downswing time ratio)
②	Backswing time
③	Downswing time
④	Your tempo
	Good timing
	Too slow
	Too fast

To find your ideal swing timing, you should start with the slowest timing and try it for a few swings. When the tempo graph is consistently green for both your backswing and downswing times, you can move up to the next timing. When you find a timing that is comfortable, you can use it to achieve more consistent swings and performance.

Analyzing Your Swing Tempo

You must hit a ball to view your swing tempo.

- 1 Press **START**.
- 2 Select **Tempo Training**.
- 3 Press **START**.
- 4 Select **Swing Speed**, and select an option.
- 5 Complete a full swing, and hit the ball.
The watch displays your swing analysis.

Viewing the Tip Sequence

The first time you use the Tempo Training activity, the watch displays a tip sequence to explain how your swing is analyzed.

- 1 During your activity, press **START**.
- 2 Select **Tips**.
- 3 Press **START** to view the next tip.

Jumpmaster

WARNING

The jumpmaster feature is for use by experienced skydivers only. The jumpmaster feature should not be used as a primary skydiving altimeter. Failure to input the appropriate jump related information can lead to serious personal injury or death.

The jumpmaster feature follows military guidelines for calculating the high altitude release point (HARP). The watch detects automatically when you have jumped to begin navigating toward the desired impact point (DIP) using the barometer and electronic compass.

Planning a Jump

- 1 Select a jump type ([Jump Types, page 57](#)).
- 2 Enter the jump information ([Entering Jump Information, page 58](#)).
The device calculates the HARP.
- 3 Select **Go To HARP** to start navigation to the HARP.

Jump Types

The jumpmaster feature allows you to set the jump type to one of three types: HAHO, HALO, or Static. The jump type selected determines what additional setup information is required. For all jump types, drop altitudes and opening altitudes are measured in feet above ground level (AGL).

HAHO: High Altitude High Opening. The jumpmaster jumps from a very high altitude and opens the parachute at a high altitude. You must set a DIP and a drop altitude of at least 1,000 feet. The drop altitude is assumed to be the same as the opening altitude. Common values for a drop altitude range from 12,000 to 24,000 feet AGL.

HALO: High Altitude Low Opening. The jumpmaster jumps from a very high altitude and opens the parachute at a low altitude. The required information is the same as the HAHO jump type, plus an opening altitude. The opening altitude must not be greater than the drop altitude. Common values for an opening altitude range from 2,000 to 6,000 feet AGL.

Static: The wind speed and direction are assumed to be constant for the duration of the jump. The drop altitude must be at least 1,000 feet.

Entering Jump Information

- 1 Press **START**.
- 2 Select **Jumpmaster**.
- 3 Select a jump type (*Jump Types, page 57*).
- 4 Complete one or more actions to enter your jump information:
 - Select **DIP** to set a waypoint for the desired landing location.
 - Select **Drop Alt.** to set the drop altitude AGL (in feet) when the jumpmaster exits the aircraft.
 - Select **Open Alt** to set the open altitude AGL (in feet) when the jumpmaster opens the parachute.
 - Select **Forward Throw** to set the horizontal distance traveled (in meters) due to aircraft speed.
 - Select **Crs. to HARP** to set the direction traveled (in degrees) due to aircraft speed.
 - Select **Wind** to set the wind speed (in knots) and direction (in degrees).
 - Select **Constant** to fine-tune some information for the planned jump. Depending on the jump type, you can select **Percent Max.**, **Safety Factor**, **K-Open**, **K-Freefall**, or **K-Static** and enter additional information (*Constant Settings, page 59*).
 - Select **Auto to DIP** to enable navigation to the DIP automatically after you jump.
 - Select **Go To HARP** to start navigation to the HARP.

Entering Wind Information for HAHO and HALO Jumps

- 1 Press **START**.
- 2 Select **Jumpmaster**.
- 3 Select a jump type (*Jump Types, page 57*).
- 4 Select **Wind > Add**.
- 5 Select an altitude.
- 6 Enter a wind speed in knots and select **Done**.
- 7 Enter a wind direction in degrees and select **Done**.

The wind value is added to the list. Only wind values included in the list are used in calculations.
- 8 Repeat steps 5–7 for each available altitude.

Resetting Wind Information

- 1 Press **START**.
- 2 Select **Jumpmaster**.
- 3 Select **HAHO** or **HALO**.
- 4 Select **Wind > Reset**.

All wind values are removed from the list.

Entering Wind Information for a Static Jump

- 1 Press **START**.
- 2 Select **Jumpmaster > Static > Wind**.
- 3 Enter a wind speed in knots and select **Done**.
- 4 Enter a wind direction in degrees and select **Done**.

Constant Settings

Select Jumpmaster, select a jump type, and select Constant.

Percent Max.: Sets the jump range for all jump types. A setting less than 100% decreases the drift distance to the DIP, and a setting greater than 100% increases the drift distance. More experienced jumpmasters may want to use smaller numbers, and less experienced skydivers may want to use larger numbers.

Safety Factor: Sets the margin of error for a jump (HAHO only). Safety factors are usually integer values of two or greater, and are determined by the jumpmaster based on specifications for the jump.

K-Freefall: Sets the wind drag value for a parachute during freefall, based on the parachute canopy rating (HALO only). Each parachute should be labeled with a K value.

K-Open: Sets the wind drag value for an open parachute, based on the parachute canopy rating (HAHO and HALO). Each parachute should be labeled with a K value.

K-Static: Sets the wind drag value for a parachute during a static jump, based on the parachute canopy rating (Static only). Each parachute should be labeled with a K value.

Customizing Activities and Apps

You can customize the activities and apps list, data screens, data fields, and other settings.

Adding or Removing a Favorite Activity

The list of your favorite activities appears when you press **START** from the watch face, and it provides quick access to the activities you use most frequently. The first time you press **START** to start an activity, the watch prompts you to select your favorite activities. You can add or remove favorite activities at any time.

- 1 Hold **MENU**.
- 2 Select **Activities & Apps**.
Your favorite activities appear at the top of the list.
- 3 Select an option:
 - To add a favorite activity, select the activity, and select **Set as Favorite**.
 - To remove a favorite activity, select the activity, and select **Remove from Favorites**.

Changing the Order of an Activity in the Apps List

- 1 Hold **MENU**.
- 2 Select **Activities & Apps**.
- 3 Select an activity.
- 4 Select **Reorder**.
- 5 Press **UP** or **DOWN** to adjust the position of the activity in the apps list.

Customizing the Data Screens

You can show, hide, and change the layout and content of data screens for each activity.

- 1 Hold **MENU**.
- 2 Select **Activities & Apps**.
- 3 Select the activity to customize.
- 4 Select the activity settings.
- 5 Select **Data Screens**.
- 6 Select a data screen to customize.
- 7 Select an option:
 - Select **Layout** to adjust the number of data fields on the data screen.
 - Select **Data Fields**, and select a field to change the data that appears in the field.
TIP: For a list of all the available data fields, go to [Data Fields, page 164](#). Not all data fields are available for all activity types.
 - Select **Left Gauge** or **Right Gauge** to add graphical dive gauges.
 - Select **Reorder** to change the location of the data screen in the loop.
 - Select **Remove** to remove the data screen from the loop.**NOTE:** Not all options are available for dive activities.
- 8 If necessary, select **Add New** to add a data screen to the loop.
You can add a custom data screen, or select one of the predefined data screens.

Adding a Map to an Activity

You can add the map to the data screens loop for an activity.

- 1 Hold **MENU**.
- 2 Select **Activities & Apps**.
- 3 Select the activity to customize.
- 4 Select the activity settings.
- 5 Select **Data Screens > Add New > Map**.

Creating a Custom Activity

- 1 From the watch face, press **START**.
- 2 Select **Add**.
- 3 Select an option:
 - Select **Copy Activity** to create your custom activity starting from one of your saved activities.
 - Select **Other > Other** to create a new custom activity.
- 4 If necessary, select an activity type.
- 5 Select a name or enter a custom name.
Duplicate activity names include a number, for example: Bike(2).
- 6 Select an option:
 - Select an option to customize specific activity settings. For example, you can customize the data screens or auto features.
 - Select **Done** to save and use the custom activity.
- 7 Select **Yes** to add the activity to your list of favorites.

Activities and App Settings

These settings allow you to customize each preloaded activity app based on your needs. For example, you can customize data pages and enable alerts and training features. Not all settings are available for all activity types. Hold **MENU**, select **Activities & Apps**, select an activity, and select the activity settings.

3D Distance: Calculates your distance traveled using your elevation change and your horizontal movement over ground.

3D Speed: Calculates your speed using your elevation change and your horizontal movement over ground.

Accent Color: Sets the accent color of each activity to help identify which activity is active.

Add Activity: Allows you to customize a multisport activity.

Alerts: Sets the training or navigation alerts for the activity ([Activity Alerts, page 63](#)).

Auto Climb: Enables the watch to detect elevation changes automatically using the built-in altimeter ([Enabling Auto Climb, page 65](#)).

Auto Lap: Sets the options for the Auto Lap feature to automatically mark laps. The Auto Distance option marks laps at a specific distance. The Auto Position option marks laps at a location where you previously pressed LAP. When you complete a lap, a customizable lap alert message appears. This feature is helpful for comparing your performance over different parts of an activity.

Auto Pause: Sets the options for the Auto Pause[®] feature to stop recording data when you stop moving or when you drop below a specified speed. This feature is helpful if your activity includes stop lights or other places where you must stop.

Auto Rest: Enables the watch to automatically create a rest interval when you stop moving ([Auto Rest and Manual Rest, page 36](#)).

Auto Run: Enables the watch to detect ski or water sport runs automatically using the built-in accelerometer ([Viewing Your Ski Runs, page 47](#), [Viewing Your Water Sport Runs, page 45](#)).

Auto Scroll: Sets the watch to scroll through all of the activity data screens automatically while the activity timer is running.

Auto Set: Enables the watch to start and stop exercise sets automatically during a strength training activity.

Auto Start: Sets the watch to automatically start a motocross or BMX activity when you start moving.

Big Numbers: Changes the size of the numbers on the activity data screens ([Big Numbers Mode, page 55](#)).

Broadcast Heart Rate: Enables automatic heart rate data broadcasting when you start the activity ([Broadcasting Heart Rate Data, page 113](#)).

Broadcast to GameOn: Enables automatic biometrics data broadcasting to the Garmin GameOn app when you start a gaming activity ([Using the Garmin GameOn™ App, page 39](#)).

ClimbPro: Displays ascent planning and monitoring screens while navigating ([Using ClimbPro, page 65](#)).

Club Prompt: Displays a prompt to enter which golf club you used after each detected shot to record your club statistics ([Recording Statistics, page 54](#)).

Countdown Start: Enables a countdown timer for pool swimming intervals.

Data Screens: Enables you to customize data screens and add new data screens for the activity ([Customizing the Data Screens, page 60](#)).

Driver Distance: Sets the average distance the ball travels on your drive while playing golf.

Edit Weight: Allows you to add the weight used for an exercise set during a strength training or cardio activity.

Flashlight Strobe: Sets the LED flashlight strobe mode, speed, and color during the activity.

Golf Distance: Sets the unit of measure for distance while playing golf.

Golf Wind Speed: Sets the unit of measure for wind speed while playing golf.

Grading System: Sets the grading system for rating the route difficulty for a rock climbing activity.

Lane Number: Sets your lane number for track running.

Lap Key: Enables or disables the LAP button for recording a lap or rest during an activity.

Lock Device: Locks the touchscreen and buttons during a multisport activity to prevent inadvertent button presses and touchscreen swipes.

Map: Sets the display preferences for the map data screen for the activity ([Activity Map Settings, page 64](#)).

Metronome: Plays tones or vibrates at a steady rhythm to help you improve your performance by training at a faster, slower, or more consistent cadence. You can set the beats per minute (bpm) of the cadence you want to maintain, beat frequency, and sound settings.

Mode Tracking: Enables or disables automatic ascent or descent mode tracking for backcountry skiing and snowboarding.

Obstacle Tracking: Enables the watch to save obstacle locations from your first loop of the course. On repeat loops of the course, the watch uses the saved locations to switch between obstacle and running intervals (*Recording an Obstacle Racing Activity, page 35*).

PlaysLike: Configures the "plays like" distance feature, which shows adjusted distances to the green while playing golf (*PlaysLike Distance Icons, page 52*).

Pool Size: Sets the pool length for pool swimming.

Power Averaging: Controls whether the watch includes zero values for bike power data that occur when you are not pedaling.

Power Mode: Sets the default power mode for the activity.

Power Save Timeout: Sets the power-save timeout length for how long your watch stays in training mode, for example, when you are waiting for a race to start. The Normal option sets the watch to enter low-power watch mode after 5 minutes of inactivity. The Extended option sets the watch to enter low-power watch mode after 25 minutes of inactivity. The extended mode can result in shorter battery life between charges.

Record Activity: Enables activity FIT file recording for golf activities. FIT files record fitness information that is tailored for Garmin Connect.

Record After Sunset: Sets the watch to record track points after sunset during an expedition.

Record Temperature: Records the ambient temperature around the watch during certain activities.

Record VO2 Max.: Enables VO2 max. recording for trail run and ultra run activities.

Recording Interval: Sets the frequency for recording track points during an expedition. By default, GPS track points are recorded once an hour, and they are not recorded after sunset. Recording track points less frequently maximizes battery life.

Rename: Sets the activity name.

Rep Counting: Enables or disables rep counting during a workout. The Workouts Only option enables rep counting during guided workouts only.

Repeat: Enables the Repeat option for multisport activities. For example, you can use this option for activities that include multiple transitions, such as a swimrun.

Restore Defaults: Allows you to reset the activity settings.

Route Stats: Enables route statistics tracking for indoor climbing activities.

Routing: Sets the preferences for calculating routes for the activity (*Routing Settings, page 64*).

Running Power: Allows you to record running power data and customize the settings (*Running Power Settings, page 122*).

Satellites: Sets the satellite system to use for the activity (*Satellite Settings, page 66*).

Scoring: Allows you to set your golf scoring preferences, enable statistics tracking, and enter your handicap (*Scoring Settings, page 54*).

Segments: Allows you to view your saved segments for the activity (*Segments, page 66*). The Auto Effort option automatically adjusts the target race time of a segment based on your performance during the segment.

Segment Alerts: Enables prompts that alert you to approaching segments (*Segments, page 66*).

Self Evaluation: Sets how often you evaluate your perceived effort for the activity (*Evaluating an Activity, page 33*).

SpeedPro: Enables advanced speed metrics for windsurf activity runs.

Stroke Detect.: Enables stroke detection for pool swimming.

Swimrun Auto Sport Change: Allows you to automatically transition between the swim portion and the run portion of a swimrun multisport activity.

Touch: Enables or disables the touchscreen during an activity.

Tournament Mode: Disables features that are not allowed during sanctioned tournaments.

Transitions: Enables transitions for multisport activities.

Units: Sets the units of measure for the activity.

Vibration Alerts: Enables alerts that notify you to inhale or exhale during a breathwork activity.

Virtual Caddie: Allows you to select automatic or manual virtual caddie club recommendations. Appears after you play five rounds of golf, track your clubs, and upload your scorecards to the Garmin Golf app.

Workout Videos: Enables instructive workout animations for a strength, cardio, yoga, or Pilates activity. Animations are available for pre-installed workouts and workouts downloaded from your Garmin Connect account.

Activity Alerts

You can set alerts for each activity, which can help you to train toward specific goals, to increase your awareness of your environment, and to navigate to your destination. Some alerts are available only for specific activities. There are three types of alerts: event alerts, range alerts, and recurring alerts.

Event alert: An event alert notifies you one time. The event is a specific value. For example, you can set the watch to alert you when you burn a specified number of calories.

Range alert: A range alert notifies you each time the watch is above or below a specified range of values. For example, you can set the watch to alert you when your heart rate is below 60 beats per minute (bpm) and over 210 bpm.

Recurring alert: A recurring alert notifies you each time the watch records a specified value or interval. For example, you can set the watch to alert you every 30 minutes.

Alert Name	Alert Type	Description
Cadence	Range	You can set minimum and maximum cadence values.
Calories	Event, recurring	You can set the number of calories.
Custom	Event, recurring	You can select an existing message or create a custom message and select an alert type.
Distance	Event, recurring	You can set a distance interval.
Elevation	Range	You can set minimum and maximum elevation values.
Heart Rate	Range	You can set minimum and maximum heart rate values or select zone changes. See About Heart Rate Zones, page 137 and Heart Rate Zone Calculations, page 139 .
Pace	Range	You can set minimum and maximum pace values.
Pacing	Recurring	You can set a target swim pace.
Power	Range	You can set the high or low power level.
Proximity	Event	You can set a radius from a saved location.
Run/Walk	Recurring	You can set timed walking breaks at regular intervals.
Speed	Range	You can set minimum and maximum speed values.
Stroke Rate	Range	You can set high or low strokes per minute.
Time	Event, recurring	You can set a time interval.
Track Timer	Recurring	You can set a track time interval in seconds.

Setting an Alert

- 1 Hold **MENU**.
- 2 Select **Activities & Apps**.
- 3 Select an activity.
NOTE: This feature is not available for all activities.
- 4 Select the activity settings.
- 5 Select **Alerts**.
- 6 Select an option:
 - Select **Add New** to add a new alert for the activity.
 - Select the alert name to edit an existing alert.
- 7 If necessary, select the type of alert.
- 8 Select a zone, enter the minimum and maximum values, or enter a custom value for the alert.
- 9 If necessary, turn on the alert.

For event and recurring alerts, a message appears each time you reach the alert value. For range alerts, a message appears each time you exceed or drop below the specified range (minimum and maximum values).

Activity Map Settings

You can customize the appearance of the map data screen for each activity.

Hold **MENU**, select **Activities & Apps**, select an activity, select the activity settings, and select **Map**.

Configure Maps: Shows or hides data from installed map products.

Map Theme: Sets the map to display data optimized for your activity type. The System option uses the preferences from the system map settings ([Map Themes, page 128](#)).

Use Sys. Settings: Enables the watch to use the preferences from the map system settings ([Map Settings, page 126](#)). When this setting is disabled, you can customize the map settings for the activity.

Restore Theme: Allows you to restore default map theme settings or themes that have been deleted from the watch.

Routing Settings

You can change the routing settings to customize the way the watch calculates routes for each activity.

NOTE: Not all settings are available for all activity types.

Hold **MENU**, select **Activities & Apps**, select an activity, select the activity settings, and select **Routing**.

Activity: Sets an activity for routing. The watch calculates routes optimized for the type of activity you are doing.

Popularity Routing: Calculates routes based on the most popular runs and rides from Garmin Connect.

Courses: Sets how you navigate courses using the watch. Use the Follow Course option to navigate a course exactly as it appears, without recalculating. Use the Use Map option to navigate a course using routable maps, and recalculate the route if you stray from the course.

Calculation Method: Sets the calculation method to minimize the time, distance, or ascent in routes.

Avoidances: Sets the road or transportation types to avoid in routes.

Type: Sets the behavior of the pointer that appears during direct routing.

Using ClimbPro

The ClimbPro feature helps you manage your effort for the upcoming climbs on a course. You can view climb details, including gradient, distance, and elevation gain, before or in real time while following a course. Cycling climb categories, based on length and gradient, are indicated by color.

- 1 Hold **MENU**.
- 2 Select **Activities & Apps**.
- 3 Select an activity.
- 4 Select the activity settings.
- 5 Select **ClimbPro > Status > When Navigating**.
- 6 Select an option:
 - Select **Data Field** to customize the data field that appears on the ClimbPro screen.
 - Select **Alert** to set alerts at the start of a climb or at a certain distance from the climb.
 - Select **Descents** to turn descents on or off for running activities.
 - Select **Climb Detection** to choose the types of climbs detected during cycling activities.
- 7 Review the climbs and course details for the course ([Viewing or Editing Course Details, page 149](#)).
- 8 Start following a saved course ([Navigating to a Destination, page 145](#)).

Enabling Auto Climb

You can use the auto climb feature to detect elevation changes automatically. You can use it during activities such as climbing, hiking, running, or biking.

- 1 Hold **MENU**.
- 2 Select **Activities & Apps**.
- 3 Select an activity.

NOTE: This feature is not available for all activities.
- 4 Select the activity settings.
- 5 Select **Auto Climb > Status**.
- 6 Select **Always** or **When Not Navigating**.
- 7 Select an option:
 - Select **Run Screen** to identify which data screen appears while running.
 - Select **Climb Screen** to identify which data screen appears while climbing.
 - Select **Invert Colors** to reverse the display colors when changing modes.
 - Select **Vertical Speed** to set the rate of ascent over time.
 - Select **Mode Switch** to set how quickly the device changes modes.

NOTE: The Current Screen option allows you to automatically switch to the last screen you were viewing before the auto climb transition occurred.

Satellite Settings

You can change the satellite settings to customize the satellite systems used for each activity. For more information about satellite systems, go to garmin.com/aboutGPS.

Hold **MENU**, select **Activities & Apps**, select an activity, select the activity settings, and select **Satellites**.

NOTE: This feature is not available for all activities.

Off: Disables satellite systems for the activity.

Use Default: Enables the watch to use the default system setting for satellites (*System Settings, page 152*).

GPS Only: Enables the GPS satellite system.

All Systems: Enables multiple satellite systems. Using multiple satellite systems together offers increased performance in challenging environments and faster position acquisition than using GPS only. However, using multiple systems can reduce battery life more quickly than using GPS only.

All + Multi-Band: Enables multiple satellite systems on multiple frequency bands. Multi-band systems use multiple frequency bands and allow for more consistent track logs, improved positioning, improved multi-path errors, and fewer atmospheric errors when using the watch in challenging environments.

Auto Select: Enables the watch to use SatIQ™ technology to dynamically select the best multi-band system based on your environment. The Auto Select setting offers the best positioning accuracy while still prioritizing battery life.

UltraTrac: Records track points and sensor data less frequently. Enabling the UltraTrac feature increases battery life but decreases the quality of recorded activities. You should use the UltraTrac feature for activities that demand longer battery life and for which frequent sensor data updates are less important.

Segments

You can send running or cycling segments from your Garmin Connect account to your device. After a segment is saved to your device, you can race a segment, trying to match or exceed your personal record or other participants who have raced the segment.

NOTE: When you download a course from your Garmin Connect account, you can download all of the available segments in the course.

Strava™ Segments

You can download Strava segments to your Descent device. Follow Strava segments to compare your performance with your past rides, friends, and pros who have ridden the same segment.

To sign up for a Strava membership, go to the segments menu in your Garmin Connect account. For more information, go to www.strava.com.

The information in this manual applies to both Garmin Connect segments and Strava segments.

Viewing Segment Details

- 1 From the watch face, press **START**.
- 2 Select an activity.
- 3 Hold **MENU**.
- 4 Select the activity settings.
- 5 Select **Segments**.
- 6 Select a segment.
- 7 Select an option:
 - Select **Race Times** to view the time and average speed or pace for the segment leader.
 - Select **Map** to view the segment on the map.
 - Select **Elevation Plot** to view an elevation plot of the segment.

Racing a Segment

Segments are virtual race courses. You can race a segment, and compare your performance to past activities, others' performance, connections in your Garmin Connect account, or other members of the running or cycling communities. You can upload your activity data to your Garmin Connect account to view your segment position.

NOTE: If your Garmin Connect account and Strava account are linked, your activity is automatically sent to your Strava account so you can review the segment position.

1 From the watch face, press **START**.

2 Select an activity.

3 Go for a run or ride.

When you approach a segment, a message appears, and you can race the segment.

4 Start racing the segment.

A message appears when the segment is complete.

Applied Ballistics®

WARNING

The Applied Ballistics feature is intended to provide accurate elevation and windage solutions based on gun and bullet profiles and measurements of current conditions only. Depending on your environment, conditions may change rapidly. Changes in environmental conditions, like wind gusts or downrange winds, may have an effect on the accuracy of your shot. Elevation and windage solutions are suggestions only based upon your input into the feature. Take readings often and carefully, and allow the readings to stabilize after significant changes in environmental conditions. Always allow a margin of safety for changing conditions and reading errors.

Always understand your target and what lies beyond your target before taking a shot. Failure to account for your shooting environment could cause property damage, injury, or death.

The Applied Ballistics feature offers customized aiming solutions for long-range shooting based on your rifle characteristics, bullet characteristics, and various environmental conditions. You can enter parameters including wind, temperature, humidity, range, and firing direction.

This feature provides the information you need to fire long-range projectiles, including elevation holdover, windage, and time of flight. It also includes custom drag models for your bullet type. Go to appliedballisticsllc.com for more details about this feature. See the *Applied Ballistics Glossary of Terms*, page 72 for descriptions of the terms and data fields.

NOTE: You may need to upgrade the ballistic solver in the AB Synapse - Garmin app to unlock all Applied Ballistics features (*AB Synapse - Garmin App*, page 67).

AB Synapse - Garmin App

The AB Synapse - Garmin app allows you to manage ballistic profiles on your Descent watch, or upgrade your ballistic solver, if necessary. You can download the AB Synapse - Garmin app from the app store on your phone.

Applied Ballistics Options

From the watch face, press **START**, select **Applied Ballistics**, and press **START**.

Quick Edit: Allows you to quickly edit the range, direction of fire, and wind information (*Quickly Editing Shooting Conditions, page 68*).

Range Card: Allows you to view data for various ranges based on user input parameters. You can change fields (*Customizing the Range Card Fields, page 69*), edit the range increment (*Editing the Range Increment, page 69*), and set the base range (*Setting the Base Range, page 69*).

Target Card: Allows you to view range, elevation, and windage for ten targets based on user input parameters.

Environment: Allows you to customize atmospheric conditions for your current environment. You can enter custom values, use the pressure and latitude values from the internal sensor in the device, or use the temperature value from a connected tempe™ sensor (*Environment, page 68*).

Target: Allows you to customize long-range shooting conditions for your current target. You can change the selected target and customize conditions for up to ten targets (*Changing the Target, page 69*).

Profile: Allows you to customize gun properties (*Editing Gun Properties, page 70*), bullet properties (*Editing Bullet Properties, page 70*), and output units of measure for your current profile. You can change the selected profile (*Selecting a Different Profile, page 69*) and add additional profiles (*Adding a Profile, page 70*).

Change Fields: Allows you to customize the data fields on the profile data screen (*Customizing the Profile Data Screen, page 70*).

Setup: Allows you to select the units of measure and enable the windage and elevation solution options.

Quickly Editing Shooting Conditions

You can edit the range, direction of fire, and wind information.

- 1 From the Applied Ballistics app, press **START**.
- 2 Select **Quick Edit**.
TIP: You can press DOWN or UP to edit each value, and press START to move to the next field.
- 3 Set the **RNG** value to the target distance.
- 4 Set the **DOF** value to your actual direction of fire (either manually or by using the compass).
- 5 Set the **W 1** value to the low wind speed.
- 6 Set the **W 2** value to the high wind speed.
- 7 Set the **DIR** value to the direction the wind is coming from.
- 8 Press **BACK** to save your settings.

Environment

Editing the Environment

- 1 From the Applied Ballistics app, press **START**.
- 2 Select **Environment**.
- 3 Select an option to edit.

Enabling Auto Update

You can use the auto update feature to update the latitude and pressure values automatically. When connected to a tempe sensor, the temperature value also updates. When connected to a weather meter, the wind speed, wind direction, and humidity values also update. The values update every five minutes.

- 1 From the Applied Ballistics app, press **START**.
- 2 Select **Environment > Auto Update > On**.

Range Card

Customizing the Range Card Fields

- 1 From the Applied Ballistics app, press **START**.
- 2 Select **Range Card**.
TIP: You can press **START** to quickly view different data fields for the third column.
- 3 Hold **MENU**.
- 4 Select **Change Fields**.
- 5 Press **START** to scroll to a field.
- 6 Press **DOWN** or **UP** to change the field.
- 7 Press **BACK** to save your changes.

Editing the Range Increment

- 1 From the Applied Ballistics app, press **START**.
- 2 Select **Range Card**.
- 3 Hold **MENU**.
- 4 Select **Range Increment**.
- 5 Enter a value.

Setting the Base Range

- 1 From the Applied Ballistics app, press **START**.
- 2 Select **Range Card**.
- 3 Hold **MENU**.
- 4 Select **Base Range**.
- 5 Enter a value.

Targets

Changing the Target

- 1 From the Applied Ballistics app, press **START**.
- 2 Select **Target**.
- 3 Select a target.
- 4 Select **Set as Current**.

Editing the Target

- 1 From the Applied Ballistics app, press **START**.
- 2 Select **Target**.
- 3 Select a target.
- 4 Select an option to edit.

Profile

Selecting a Different Profile

- 1 From the Applied Ballistics app, press **START**.
- 2 Select **Profile > Profile**.
- 3 Select a profile.
- 4 Select **Change Profile**.

Adding a Profile

You can add a .pro file that contains profile information by creating it using the AB Synapse - Garmin app and transferring the file to the AB folder on the device. You can also create a profile using your Garmin device.

- 1 From the Applied Ballistics app, press **START**.
- 2 Select **Profile > Profile > + Profile**.
- 3 Select an option:
 - To customize the bullet properties, select **Bullet Properties** (*Editing Bullet Properties, page 70*).
 - To customize the gun properties, select **Gun Properties** (*Editing Gun Properties, page 70*).
 - To change the units of measure for the output fields, select **Output Units**.

Deleting a Profile

- 1 From the Applied Ballistics app, press **START**.
- 2 Select **Profile > Profile**.
- 3 Select a profile.
- 4 Select **Delete Profile**.

Customizing the Profile Data Screen

- 1 During an Applied Ballistics activity, press **DOWN** to scroll to the profile data screen.
- 2 Press **START**.
- 3 Select **Change Fields**.
- 4 Press **DOWN** or **UP** to scroll to a field.
- 5 Press **START** to change the field.
- 6 Press **BACK** to save your changes.

Editing Bullet Properties

- 1 From the Applied Ballistics app, press **START**.
- 2 Select **Profile > Bullet Properties**.
- 3 Select an option:
 - To automatically enter bullet properties from the Applied Ballistics bullet database, select **Bullet Database**, select your ballistic solver, and select the bullet caliber, manufacturer, bullet, and drag curve.
NOTE: You can select the caliber of your bullet to search a list of bullets within that caliber. Not all cartridge names match the actual bullet caliber. For example, a 300 Win Mag is a .308 caliber bullet.
 - To manually enter bullet properties if your bullet is not in the bullet database, press **DOWN** to scroll through the options, and select the values to edit.
NOTE: You can find this information on the bullet manufacturer's website.

Editing Gun Properties

- 1 From the Applied Ballistics app, press **START**.
- 2 Select **Profile > Gun Properties**.
- 3 Select an option to edit.

Calibrating the Muzzle Velocity

Calibrating the muzzle velocity provides a more accurate solution in the supersonic range for your specific firearm.

- 1 From the Applied Ballistics app, press **START**.
- 2 Select **Profile > Gun Properties > Calibrate Muzzle Velocity**.
- 3 Select an option:
 - Select **Range** to edit the range.
 - Select **True Drop** to edit the drop distance.
- 4 Select .

Calibrating the Drop Scale Factor

Garmin recommends you calibrate the muzzle velocity prior to the drop scale factor.

Calibrating the drop scale factor provides a more accurate solution at or beyond the transonic range for your specific firearm.

- 1 From the Applied Ballistics app, press **START**.
- 2 Select **Profile > Gun Properties > Calibrate DSF**.
- 3 Select an option:
 - Select **Range** to edit the range.
 - Select **True Drop** to edit the drop distance.
- 4 Select **✓**.

Viewing the Drop Scale Factor Table

The drop scale factor table is populated after you calibrate the drop scale factor. If necessary, you can reset the table values to zero.

- 1 From the Applied Ballistics app, press **START**.
- 2 Select **Profile > Gun Properties > View DSF Table**.
- 3 If necessary, hold **MENU**, and select **Clear DSF Table**.
The table values reset to zero.

Editing the Muzzle Velocity and Temperature Table

- 1 From the Applied Ballistics app, press **START**.
- 2 Select **Profile > Gun Properties > MV-Temp Table**.
- 3 Hold **MENU**.
- 4 Select **Edit**.
- 5 Press **DOWN** or **UP** to scroll through the table.
- 6 Press **START** to edit a value.
- 7 Press **BACK** to save your changes.
- 8 Press **BACK**.
- 9 Select **Muzzle Velocity > Enable MV-Temp** to set the muzzle velocity using the temperature table.

Clearing the Muzzle Velocity and Temperature Table

- 1 From the Applied Ballistics app, press **START**.
- 2 Select **Profile > Gun Properties > MV-Temp Table**.
- 3 Hold **MENU**.
- 4 Select **Clear MV-Temp**.

Applied Ballistics Glossary of Terms

Shooting Solution Fields

DOF: The direction of fire, with north at 0 degrees and east at 90 degrees. Input field.

TIP: You can use the compass to set this value by pointing the top of the device toward the direction of fire. The current compass value appears in the DOF field. You can press START to use this value. You can manually enter a value by pressing DOWN or UP.

NOTE: The DOF is used only for calculating the Coriolis effect. If you are shooting at a target less than 1,000 yards away, this input field is optional.

Elevation: The vertical portion of the aiming solution, displayed in milliradians (mil) or minute of angle (MOA).

RNG: The distance to the target, displayed in yards or meters. Input field.

W 1/2: The wind speed 1, wind speed 2, and wind direction. For example, if the wind direction (DIR) is 9:00, the wind is blowing left to right as viewed by the shooter. Input field.

NOTE: The wind speed 2 field is optional. Using both wind speed 1 and wind speed 2 is not an effective way to account for different wind speeds at different distances between you and the target. Using these fields is a way to bracket (isolate) the wind values and calculate minimum and maximum windage values for the solution.

Windage 1: The horizontal portion of the aiming solution based on the wind speed 1 and wind direction, displayed in milliradians (mil) or minute of angle (MOA).

Windage 2: The horizontal portion of the aiming solution based on the wind speed 2 and wind direction, displayed in milliradians (mil) or minute of angle (MOA).

Additional Output Fields

Aero. Jump. Effect: The amount of the elevation solution attributed to aerodynamic jump. Aerodynamic jump is the vertical deflection of the bullet due to a crosswind. Aerodynamic jump is calculated based on the wind speed 1 value. If there is no crosswind component or wind value, this value is zero.

Bullet Drop: The total drop the bullet experiences along its flight path, displayed in inches.

Cos. Incl. Ang.: The cosine of the inclination angle to the target.

H. Cor. Effect: The horizontal Coriolis effect. The horizontal Coriolis effect is the amount of the windage solution attributed to the Coriolis effect. This is always calculated by the device, although the impact may be minimal if you are not shooting at extended range.

Lead: The horizontal correction needed to hit a target moving left or right at a given speed.

TIP: When you enter the speed of your target, the device factors the necessary windage required into the total windage value.

Max. Ord.: The maximum ordinance. The maximum ordinance is the maximum height above the axis of the barrel that a bullet will reach along its flight path.

Max. Ord. Range: The range at which the bullet will reach its maximum ordinance.

Remaining Energy: The remaining energy of the bullet at target impact, displayed in foot-pounds of force (ft. lbf) or joules (J).

Spin Drift: The amount of the windage solution attributed to the spin drift (gyroscopic drift). For example, in the northern hemisphere, a bullet shot out of a right-hand twist barrel will always deflect slightly to the right as it travels.

Time of Flight: The time of flight, which indicates the time required for a bullet to reach its target at a given range.

V. Cor. Effect: The vertical Coriolis effect. The vertical Coriolis effect is the amount of the elevation solution attributed to the Coriolis effect. This is always calculated by the device, although the impact may be minimal if you are not shooting at extended range.

Velocity: The estimated velocity of the bullet when it impacts the target.

Velocity Mach: The estimated velocity of the bullet when it impacts the target, displayed as a factor of mach speed.

Environment Fields

Amb/Stn Pressure: The ambient (station) pressure. Ambient pressure is not adjusted to represent sea level (barometric) pressure. Ambient pressure is required for the ballistics shooting solution. Input field.

TIP: You can manually enter this value, or you can select the Use Current Pressure option to use the pressure value from the internal sensor in the device.

Humidity: The percentage of moisture in the air. Input field.

Latitude: The horizontal location on the Earth's surface. Negative values are below the equator. Positive values are above the equator. This value is used to calculate the vertical and horizontal Coriolis drift. Input field.

TIP: You can select the Use Current Position option to use the GPS coordinates from your device.

NOTE: The Latitude is used only for calculating the Coriolis effect. If you are shooting at a target less than 1,000 yards away, this input field is optional.

Temperature: The temperature at your current location. Input field.

TIP: You can manually enter the temperature reading from a connected temperature sensor or other temperature source. This field does not automatically update when connected to a temperature sensor.

Wind Direction: The direction from which the wind is coming. For example, a 9:00 wind blows from your left to your right. Input field.

Wind Speed 1: The wind speed used in the shooting solution. Input field.

Wind Speed 2: An optional, additional wind speed used in the shooting solution. Input field.

TIP: You can use two wind speeds to calculate a windage solution that contains a high and low value. The actual windage to apply for the shot should fall in this range.

Target Fields

Direction of Fire: The direction of fire, with north at 0 degrees and east at 90 degrees. Input field.

NOTE: The Direction of Fire is used only for calculating the Coriolis effect. If you are shooting at a target less than 1,000 yards away, this input field is optional.

Inclination: The angle of inclination of the shot. A negative value indicates a downhill shot. A positive value indicates an uphill shot. The shooting solution multiplies the vertical portion of the solution by the cosine of the inclination angle to calculate the adjusted solution for an uphill or downhill shot. Input field.

Range: The distance to the target, displayed in yards or meters. Input field.

Speed: The speed of a moving target, displayed in miles per hour (mph) or kilometers per hour (km/h). A negative value indicates a target moving left. A positive value indicates a target moving right. Input field.

Profile Fields, Bullet Properties

Ballistic Coefficient: The manufacturer's ballistic coefficient for your bullet. Input field.

TIP: When you use one of the Applied Ballistics custom drag curves, the ballistic coefficient will display a value of 1.000.

Bullet Diameter: The bullet diameter measured in inches. Input field.

NOTE: The diameter of the bullet may vary from the common name of the round. For example, a 300 Win Mag is actually .308 inches in diameter.

Bullet Length: The length of the bullet measured in inches. Input field.

Bullet Weight: The bullet weight measured in grains. Input field.

Drag Curve: The Applied Ballistics custom drag curve, or the G1 or G7 standard projectile models. Input field.

NOTE: Most long range rifle bullets are closer to the G7 standard.

Profile Fields, Gun Properties

Muzzle Velocity: The speed of the bullet as it leaves the muzzle. Input field.

NOTE: This field is required for accurate calculations by the shooting solution. If you calibrate the muzzle velocity, this field may be updated automatically for a more accurate firing solution.

Output Units: The output units of measure. A milliradian (mil) is 3.438 inches at 100 yards. A minute of angle (MOA) is 1.047 inches at 100 yards.

Sight Height: The distance from the center axis of the rifle barrel to the center axis of the scope. Input field.

TIP: You can easily determine this value by measuring from the top of the bolt to the center of the windage turret, and adding half of the diameter of the bolt.

SSF - Elevation: A linear multiplier that accounts for vertical scaling. Not all rifle scopes track perfectly, so the ballistics solution requires a correction to scale according to a particular rifle scope. For example, if a turret is moved 10 mil but the impact is 9 mil, the sight scale is 0.9. Input field.

SSF - Windage: A linear multiplier that accounts for horizontal scaling. Not all rifle scopes track perfectly, so the ballistics solution requires a correction to scale according to a particular rifle scope. For example, if a turret is moved 10 mil but the impact is 9 mil, the sight scale is 0.9. Input field.

Twist Rate: The distance it takes for the rifling of your barrel to make one full rotation. Rifle twist is often provided by the gun or barrel manufacturer. Input field.

Zero Height: An optional modification to impact elevation at zero range. This is often used when adding a suppressor or using a subsonic load. For example, if you add a suppressor and your bullet impacts the target 1 inch higher than expected, your Zero Height is 1 inch. You must set this to zero when you remove the suppressor. Input field.

Zero Offset: An optional modification to impact windage at zero range. This is often used when adding a suppressor or using a subsonic load. For example, if you add a suppressor and your bullet impacts the target 1 inch to the left of the expected impact, your Zero Offset is -1 inch. You must set this to zero when you remove the suppressor. Input field.

Zero Range: The range at which the rifle was zeroed. Input field.

Profile Fields, Gun Properties, Calibrate Muzzle Velocity

Range: The distance from the muzzle to the target. Input field.

TIP: You should enter a value as close as possible to the range suggested in the shooting solution. This is the range where the bullet slows to Mach 1.2 and begins to enter the transonic range.

True Drop: The actual distance the bullet falls while in flight to the target, displayed in milliradians (mil) or minute of angle (MOA). Input field.

Profile Fields, Gun Properties, Calibrate Drop Scale Factor

Range: The range from which you are shooting. Input field.

TIP: This range should be within 90% of the recommended range suggested in the shooting solution. Values that are less than 80% of the recommended range will not provide a valid adjustment.

True Drop: The actual distance the bullet falls when fired at a specific range, displayed in milliradians (mil) or minute of angle (MOA). Input field.

Training

Unified Training Status

When you use more than one Garmin device with your Garmin Connect account, you can choose which device is the primary data source for everyday use and for training purposes.

From the Garmin Connect app, select **••• > Settings**.

Primary Training Device: Sets the priority data source for training metrics like your training status and load focus.

Primary Wearable: Sets the priority data source for daily health metrics like steps and sleep. This should be the watch you wear most often.

TIP: For the most accurate results, Garmin recommends that you sync often with your Garmin Connect account.

Syncing Activities and Performance Measurements

You can sync activities and performance measurements from other Garmin devices to your Descent watch using your Garmin Connect account. This allows your watch to more accurately reflect your training and fitness. For example, you can record a ride with an Edge® bike computer, and view your activity details and recovery time on your Descent watch.

Sync your Descent watch and other Garmin devices to your Garmin Connect account.

TIP: You can set a primary training device and primary wearable in the Garmin Connect app ([Unified Training Status, page 74](#)).

Recent activities and performance measurements from your other Garmin devices appear on your Descent watch.

Training for a Race Event

Your watch can suggest daily workouts to help you train for a running or cycling event, if you have a VO2 max. estimate ([About VO2 Max. Estimates, page 92](#)).

- 1 On your phone or computer, go to your Garmin Connect calendar.
- 2 Select the day of the event, and add the race event.
You can search for an event in your area or create your own event.
- 3 Add details about the event, and add the course if it's available.
- 4 Sync your watch with your Garmin Connect account.
- 5 On your watch, scroll to the primary event glance to see a countdown to your primary race event.
- 6 From the watch face, press **START**, and select a running or cycling activity.

NOTE: If you have completed at least 1 outdoor run with heart rate data or 1 ride with heart rate and power data, daily suggested workouts appear on your watch.

Race Calendar and Primary Race

When you add a race event to your Garmin Connect calendar, you can view the event on your watch by adding the primary race glance ([Glances, page 86](#)). The event date must be in the next 365 days. The watch displays a countdown to the event, your goal time or predicted finish time (running events only), and weather information.

NOTE: Historical weather information for the location and date is available right away. Local forecast data appears approximately 14 days before the event.

If you add more than one race event, you are prompted to choose a primary event.

Depending on the available course data for your event, you can view elevation data, the course map, and add a PacePro™ plan ([PacePro Training, page 79](#)).

Workouts

You can create custom workouts that include goals for each workout step and for varied distances, times, and calories. During your activity, you can view workout-specific data screens that contain workout step information, such as the workout step distance or average step pace.

On your watch: You can open the workouts app from the activity list to show all workouts currently loaded on your watch ([Activities and Apps, page 32](#)).

You can also view your workout history.

On the app: You can create and find more workouts, or select a training plan that has built-in workouts and transfer them to your watch ([Following a Workout From Garmin Connect, page 76](#)).

You can schedule workouts.

You can update and edit your current workouts.

Starting a Workout

Your device can guide you through multiple steps in a workout.

- 1 From the watch face, press **START**.
- 2 Select an activity.
- 3 Hold **MENU**, and select **Training**.
- 4 Select an option:
 - To start an interval workout or a workout with a training target, select **Quick Workout** (*Starting an Interval Workout, page 77, Setting a Training Target, page 78*).
 - To start a preloaded or saved workout, select **Workout Library** (*Following a Workout From Garmin Connect, page 76*).
 - To start a scheduled workout from your Garmin Connect training calendar, select **Training Calendar** (*About the Training Calendar, page 79*).

NOTE: Not all options are available for all activity types.

- 5 Select a workout.



NOTE: Only workouts that are compatible with the selected activity appear in the list.

- 6 If necessary, select **Do Workout**.
- 7 Press **START** to start the activity timer.

After you begin a workout, the device displays each step of the workout, step notes (optional), the target (optional), and the current workout data. For strength, yoga, cardio, or Pilates activities, an instructional animation appears.

Workout Execution Score

After you complete a workout, the watch displays your workout execution score based on how accurately you completed the workout. For example, if your 60 minute workout has a target pace range, and you stay in that range for 50 minutes, your workout execution score is 83%.

	Good, 67 to 100%
	Average, 34 to 66%
	Low, 0 to 33%

Following a Workout From Garmin Connect

Before you can download a workout from Garmin Connect, you must have a Garmin Connect account (*Garmin Connect, page 134*).

- 1 Select an option:
 - Open the Garmin Connect app, and select ●●●.
 - Go to connect.garmin.com.
- 2 Select **Training & Planning > Workouts**.
- 3 Find a workout, or create and save a new workout.
- 4 Select  or **Send to Device**.
- 5 Follow the on-screen instructions.

Following a Daily Suggested Workout

Before the watch can suggest a daily run or bike workout, you must have a VO2 max. estimate for that activity ([About VO2 Max. Estimates](#), page 92).

- 1 From the watch face, press **START**.
- 2 Select **Run** or **Bike**.
The daily suggested workout appears.
- 3 Press **START**, and select an option:
 - To do the workout, select **Do Workout**.
 - To discard the workout, select **Dismiss**.
 - To preview the workout steps, select **Steps**.
 - To view workout suggestions for the upcoming week, select **More Suggestions**.
 - To view the workout settings, such as **Target Type**, select **Settings**.

The suggested workout updates automatically to changes in training habits, recovery time, and VO2 max.

Starting an Interval Workout

- 1 From the watch face, press **START**.
- 2 Select an activity.
- 3 Hold **MENU**.
- 4 Select **Training > Quick Workout > Intervals**.
- 5 Select an option:
 - Select **Open Repeats** to mark your intervals and rest periods manually by pressing **LAP**.
 - Select **Structured Repeats > Do Workout** to use an interval workout based on distance or time.
- 6 If necessary, select **Yes** to include a warm up before the workout.
- 7 Press **START** to start the activity timer.
- 8 When your interval workout has a warm up, press **LAP** to begin the first interval.
- 9 Follow the on-screen instructions.
- 10 At any time, press **LAP** to stop the current interval or rest period and transition to the next interval or rest period (optional).

After you complete all of the intervals, a message appears.

Customizing an Interval Workout

- 1 From the watch face, press **START**.
- 2 Select an activity.
- 3 Hold **MENU**.
- 4 Select **Training > Quick Workout > Intervals > Structured Repeats > Edit**.
- 5 Select one or more options:
 - To set the interval duration and type, select **Interval**.
 - To set the rest duration and type, select **Rest**.
 - To set the number of repetitions, select **Repeat**.
 - To add an open-ended warm up to your workout, select **Warm Up > On**.
 - To add an open-ended cool down to your workout, select **Cool Down > On**.
- 6 Press **BACK**.

The watch saves your custom interval workout until you edit the workout again.

Recording a Critical Swim Speed Test

Your Critical Swim Speed (CSS) value is the result of a time-trial-based test expressed as a pace per 100 meters. Your CSS is the theoretical speed you can maintain continuously without exhaustion. You can use your CSS to guide your training pace and monitor your improvement.

- 1 From the watch face, press **START**.
- 2 Select **Pool Swim**.
- 3 Hold **MENU**.
- 4 Select **Training > Workout Library > Critical Swim Speed > Do Critical Swim Speed Test**.
- 5 Press **DOWN** to preview the workout steps (optional).
- 6 Press **START**.
- 7 Press **START** to start the activity timer.
- 8 Follow the on-screen instructions.

Using Virtual Partner

Your Virtual Partner is a training tool designed to help you meet your goals. You can set a pace for the Virtual Partner and race against it.

NOTE: This feature is not available for all activities.

- 1 Hold **MENU**.
- 2 Select **Activities & Apps**.
- 3 Select an activity.
- 4 Select the activity settings.
- 5 Select **Data Screens > Add New > Virtual Partner**.
- 6 Enter a pace or speed value.
- 7 Press **UP** or **DOWN** to change the location of the Virtual Partner screen (optional).
- 8 Start your activity ([Starting an Activity, page 32](#)).
- 9 Press **UP** or **DOWN** to scroll to the Virtual Partner screen and see who is leading.

Setting a Training Target

The training target feature works with the Virtual Partner feature so you can train toward a set distance, distance and time, distance and pace, or distance and speed goal. During your training activity, the watch gives you real-time feedback about how close you are to achieving your training target.

- 1 From the watch face, press **START**.
- 2 Select an activity.
- 3 Hold **MENU**.
- 4 Select **Training**.
- 5 Select an option:
 - Select **Set a Target**.
 - Select **Quick Workout**.

NOTE: Not all options are available for all activity types.

- 6 Select an option:
 - Select **Distance Only** to select a preset distance or enter a custom distance.
 - Select **Distance and Time** to select a distance and time target.
 - Select **Distance and Pace** or **Distance and Speed** to select a distance and pace or speed target.

The training target screen appears and displays your estimated finish time.

- 7 Press **START** to start the activity timer.

TIP: You can hold **MENU**, and select **Cancel Target** to cancel the training target.

Racing a Previous Activity

You can race a previously recorded or downloaded activity. This feature works with the Virtual Partner feature so you can see how far ahead or behind you are during the activity.

NOTE: This feature is not available for all activities.

- 1 From the watch face, press **START**.
- 2 Select an activity.
- 3 Hold **MENU**.
- 4 Select **Training > Race Yourself**.
- 5 Select an option:
 - Select **From History** to select a previously recorded activity from your device.
 - Select **Downloaded** to select an activity you downloaded from your Garmin Connect account.
- 6 Select the activity.

The Virtual Partner screen appears indicating your estimated finish time.
- 7 Press **START** to start the activity timer.
- 8 After you complete your activity, press **STOP**, and select **Save**.

About the Training Calendar

The training calendar on your watch is an extension of the training calendar or schedule you set up in your Garmin Connect account. After you have added a few workouts to the Garmin Connect calendar, you can send them to your device. All scheduled workouts sent to the device appear in the calendar glance. When you select a day in the calendar, you can view or do the workout. The scheduled workout stays on your watch whether you complete it or skip it. When you send scheduled workouts from Garmin Connect, they overwrite the existing training calendar.

Using Garmin Connect Training Plans

Before you can download and use a training plan, you must have a Garmin Connect account ([Garmin Connect](#), page 134), and you must pair the Descent watch with a compatible phone.

- 1 From the Garmin Connect app, select **•••**.
- 2 Select **Training & Planning > Training Plans**.
- 3 Select and schedule a training plan.
- 4 Follow the on-screen instructions.
- 5 Review the training plan in your calendar.

Adaptive Training Plans

Your Garmin Connect account has an adaptive training plan and Garmin coach to fit your training goals. For example, you can answer a few questions and find a plan to help you complete a 5 km race. The plan adjusts to your current level of fitness, coaching and schedule preferences, and race date. When you start a plan, the Garmin coach glance is added to the glance loop on your Descent watch.

PacePro Training

Many runners like to wear a pace band during a race to help achieve their race goal. The PacePro feature allows you to create a custom pace band based on distance and pace or distance and time. You can also create a pace band for a known course to optimize your pace effort based on elevation changes.

You can create a PacePro plan using the Garmin Connect app. You can preview the splits and elevation plot before you run the course.

Downloading a PacePro Plan from Garmin Connect

Before you can download a PacePro plan from Garmin Connect, you must have a Garmin Connect account ([Garmin Connect, page 134](#)).

- 1 Select an option:
 - Open the Garmin Connect app, and select ●●●.
 - Go to connect.garmin.com.
- 2 Select **Training & Planning > PacePro Pacing Strategies**.
- 3 Follow the on-screen instructions to create and save a PacePro plan.
- 4 Select  or **Send to Device**.

Creating a PacePro Plan on Your Watch

Before you can create a PacePro plan on your watch, you must create a course ([Creating a Course on Garmin Connect, page 148](#)).

- 1 From the watch face, press **START**.
- 2 Select an outdoor running activity.
- 3 Hold **MENU**.
- 4 Select **Navigation > Courses**.
- 5 Select a course.
- 6 Select **PacePro > Create New**.
- 7 Select an option:
 - Select **Goal Pace**, and enter your target pace.
 - Select **Goal Time**, and enter your target time.The watch displays your custom pace band.
- 8 Press **START**.
- 9 Select an option:
 - Select **Accept Plan** to start the plan.
 - Select **View Splits** to preview the splits.
 - Select **Elevation Plot** to view an elevation plot of the course.
 - Select **Map** to view the course on the map.
 - Select **Remove** to discard the plan.

Starting a PacePro Plan

Before you can start a PacePro plan, you must download a plan from your Garmin Connect account.

- 1 From the watch face, press **START**.
- 2 Select an outdoor running activity.
- 3 Hold **MENU**.
- 4 Select **Training > PacePro Plans**.
- 5 Select a plan.
- 6 Press **START**.

TIP: You can preview the splits, elevation plot, and the map before you accept the PacePro plan.

- 7 Select **Accept Plan** to start the plan.
- 8 If necessary, select **Yes** to enable course navigation.
- 9 Press **START** to start the activity timer.

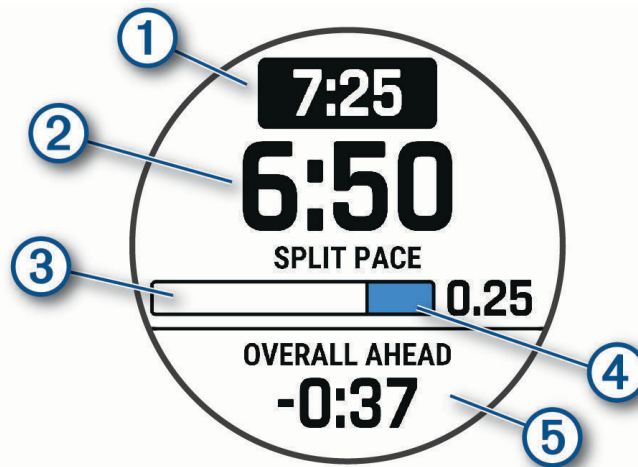

①	Target split pace
②	Current split pace
③	Completion progress for the split
④	Distance remaining in the split
⑤	Overall time ahead of or behind your target time

TIP: You can hold **MENU**, and select **Stop PacePro > Yes** to stop the PacePro plan. The activity timer continues running.

Power Guide

You can create and use a power strategy to plan your effort on a course. Your Descent device uses your FTP, the course elevation, and the projected time it will take you to complete the course to create a customized power guide.

One of the most important steps in planning a successful power guide strategy is choosing your effort level. Putting a harder effort into the course will increase the power recommendations, while choosing an easier effort will reduce them (*Creating and Using a Power Guide, page 82*). The primary goal of a power guide is to help you complete the course based on what is known about your ability, not to achieve a specific target time. You can adjust the effort level during your ride.

Power guides are always associated with a course and cannot be used with workouts or segments. You can view and edit your strategy in the Garmin Connect app and sync it with compatible Garmin devices. This feature requires a power meter, which must be paired with your device (*Pairing Your Wireless Sensors, page 120*).

Creating and Using a Power Guide

Before you can create a power guide, you must pair a power meter with your watch (*Pairing Your Wireless Sensors, page 120*). You must also have a course loaded to your watch (*Creating a Course on Garmin Connect, page 148*).

You can also create a power guide in the Garmin Connect app.

- 1 From the watch face, press **START**.
- 2 Select an outdoor biking activity.
- 3 Hold **MENU**.
- 4 Select **Training > Power Guide > Create New**.
- 5 Select a course (*Courses, page 147*).
- 6 Select a riding position.
- 7 Select a gear weight.
- 8 Press **START**, and select **Use Plan**.

TIP: You can preview the map, elevation plot, effort, settings, and splits. You can also adjust the effort, terrain, riding position, and gear weight before you start riding.

History

History includes time, distance, calories, average pace or speed, lap data, and optional sensor information.

NOTE: When the device memory is full, your oldest data is overwritten.

Using History

History contains previous activities you have saved on your watch.

The watch has a history glance for quick access to your activity data ([Glances, page 86](#)).

- 1 From the watch face, hold **MENU**.
- 2 Select **History > Activities**.
- 3 Select an activity.
- 4 Press **START**.
- 5 Select an option:
 - To view additional information about the activity, select **All Stats**.
 - To view the impact of the activity on your aerobic and anaerobic fitness, select **Training Effect** ([About Training Effect, page 102](#)).
 - To view your time in each heart rate zone, select **Heart Rate**.
 - To view your time in each power zone, select **Running Power** or **Power**.
 - To select a lap and view additional information about each lap, select **Laps**.
 - To select a ski or snowboard run and view additional information about each run, select **Runs**.
 - To select an exercise set and view additional information about each set, select **Sets**.
 - To view the activity on a map, select **Map**.
 - To view an elevation plot for the activity, select **Elevation Plot**.
 - To delete the selected activity, select **Delete**.

Multisport History

Your device stores the overall multisport summary of the activity, including overall distance, time, calories, and optional accessory data. Your device also separates the activity data for each sport segment and transition so you can compare similar training activities and track how quickly you move through the transitions. Transition history includes distance, time, average speed, and calories.

Personal Records

When you complete an activity, the watch displays any new personal records you achieved during that activity. Personal records include your fastest time over several typical race distances, highest strength activity weight for major movements, and longest run, ride, or swim.

NOTE: For cycling, personal records also include most ascent and best power (power meter required).

Viewing Your Personal Records

- 1 From the watch face, hold **MENU**.
- 2 Select **History > Records**.
- 3 Select a sport.
- 4 Select a record.
- 5 Select **View Record**.

Restoring a Personal Record

You can set each personal record back to the one previously recorded.

- 1 From the watch face, hold **MENU**.
- 2 Select **History > Records**.
- 3 Select a sport.
- 4 Select a record to restore.
- 5 Select **Previous > Yes**.

NOTE: This does not delete any saved activities.

Clearing Personal Records

- 1 From the watch face, hold **MENU**.
- 2 Select **History > Records**.
- 3 Select a sport.
- 4 Select an option:
 - To delete one record, select a record, and select **Clear Record > Yes**.
 - To delete all records for the sport, select **Clear All Records > Yes**.

NOTE: This does not delete any saved activities.

Viewing Data Totals

You can view the accumulated distance and time data saved to your watch.

- 1 From the watch face, hold **MENU**.
- 2 Select **History > Totals**.
- 3 Select an activity.
- 4 Select an option to view weekly or monthly totals.

Using the Odometer

The odometer automatically records the total distance traveled, elevation gained, and time in activities.

- 1 From the watch face, hold **MENU**.
- 2 Select **History > Totals > Odometer**.
- 3 Press **UP** or **DOWN** to view odometer totals.

Deleting History

- 1 From the watch face, hold **MENU**.
- 2 Select **History > Options**.
- 3 Select an option:
 - Select **Delete All Activities** to delete all activities from the history.
 - Select **Reset Totals** to reset all distance and time totals.

NOTE: This does not delete any saved activities.

Appearance

You can customize the appearance of the watch face and the quick access features in the glance loop and controls menu.

Watch Face Settings

You can customize the appearance of the watch face by selecting the layout, colors, and additional data. You can also download custom watch faces from the Connect IQ store.

Default Watch Face



- ① Alternate time zone pointer. References the 24-hour time markings on the watch ([Adding Alternate Time Zones, page 31](#)).
- ② No-fly time remaining. References the 24-hour time markings on the watch ([No-Fly Time, page 8](#)).
- ③ Surface interval (SI) time after a dive ([Viewing the Surface Interval Glance, page 21](#)).

Customizing the Watch Face

Before you can activate a Connect IQ watch face, you must install a watch face from the Connect IQ store ([Connect IQ Features, page 135](#)).

You can customize the watch face information and appearance, or activate an installed Connect IQ watch face.

- 1 From the watch face, hold **MENU**.
 - 2 Select **Watch Face**.
 - 3 Press **UP** or **DOWN** to preview the watch face options.
 - 4 Select **Add New** to create a custom digital or analog watch face.
 - 5 Press **START**.
 - 6 Select an option:
 - To activate the watch face, select **Apply**.
 - To change the style of the numbers for the analog watch face, select **Dial**.
 - To change the style of the hands for the analog watch face, select **Hands**.
 - To change the style of the numbers for the digital watch face, select **Layout**.
 - To change the style of the seconds for the digital watch face, select **Seconds**.
 - To change the data that appears on the watch face, select **Data**.
 - To add or change an accent color for the watch face, select **Accent Color**.
 - To enable a low brightness mode for the watch face while in dark environments, select **Lume**.
 - To change the time zone used for the alternate time zone pointer on the default watch face, select **Alt. Time Zones** ([Editing an Alternate Time Zone, page 32](#)).
- NOTE:** The alternate time zone pointer uses the first alternate time zone from the list.
- To change the color of the data that appears on the watch face, select **Data Color**.
 - To remove the watch face, select **Delete**.

Glances

Your watch comes preloaded with glances that provide quick information ([Viewing the Glance Loop, page 89](#)). Some glances require a Bluetooth connection to a compatible phone.

Some glances are not visible by default. You can add them to the glance loop manually ([Customizing the Glance Loop, page 90](#)).

Name	Description
ABC	Displays combined altimeter, barometer, and compass information.
Alternate time zones	Displays the current time of day in additional time zones (Adding Alternate Time Zones, page 31).
Altitude acclimation	At altitudes above 800 m (2625 ft.), displays graphs showing altitude-corrected values for your average pulse oximeter reading, respiration rate, and resting heart rate for the last seven days.
Altimeter	Displays the approximate elevation based on pressure changes.
Barometer	Displays the environmental pressure data based on elevation.
Body Battery™	With all-day wear, displays your current Body Battery level and a graph of your level for the last several hours (Body Battery, page 90).
Calendar	Displays upcoming meetings from your phone calendar.
Calories	Displays your calorie information for the current day.
Compass	Displays an electronic compass.
Cycling Ability	Displays your rider type, aerobic endurance, aerobic capacity, and anaerobic capacity (Viewing Cycling Ability, page 105).
Dive log	Displays brief summaries of your recently recorded dives (Viewing the Dive Log Glance, page 22).
Dive readiness	Displays a score and a short message that helps you determine how ready you are for diving each day (Dive Readiness, page 22).
Dog tracking	Displays your dog's location information when you have a compatible dog tracking device paired with your Descent watch.
Endurance score	Displays a score, graph, and a short message that describes your overall endurance based on all recorded activities (Endurance Score, page 104).
Fish forecast	Displays predictions for the best days and times for fishing based on your location, the moon's position, and the moon rise and set times. You can view the rating for the day and major and minor feeding times.
Floors climbed	Tracks your floors climbed and progress toward your goal.
Garmin coach	Displays scheduled workouts when you select a Garmin coach adaptive training plan in your Garmin Connect account. The plan adjusts to your current level of fitness, coaching and schedule preferences, and race date.
Golf	Displays golf scores and statistics for your last round.
Health Snapshot	Starts a Health Snapshot session on your watch that records several key health metrics while you hold still for two minutes. It provides a glimpse of your overall cardiovascular status. The watch records metrics such as your average heart rate, stress level, and respiration rate. Displays summaries of your saved Health Snapshot sessions (Health Snapshot™, page 37).
Heart rate	Displays your current heart rate in beats per minute (bpm) and a graph of your average resting heart rate (RHR).
Hill score	Displays a score, graph, contributing metrics, and a short message that describes your hill climbing performance based on your recorded running activities (Hill Score, page 105).

Name	Description
History	Displays your activity history and a graph of your recorded activities.
HRV Status	Displays your seven-day average of your overnight heart rate variability (<i>Heart Rate Variability Status, page 94</i>).
Intensity minutes	Tracks your time spent participating in moderate to vigorous activities, your weekly intensity minutes goal, and progress toward your goal.
inReach® controls	Allows you to send messages on your paired inReach device (<i>Using the inReach Remote, page 123</i>).
Jet Lag Adviser	Displays your internal clock during travel, and provides guidance to help you acclimate to the time zone of your destination (<i>Using the Jet Lag Adviser, page 106</i>).
Last activity	Displays a brief summary of your last recorded activity.
Last ride Last run Last swim	Displays a brief summary of your last recorded activity and history of the specified sport.
Moon phase	Displays the moonrise and moonset times, along with the moon phase, based on your GPS position.
Music controls	Provides music player controls for your phone or watch music.
Naps	Displays total nap time and Body Battery level gains. You can start the nap timer and set an alarm to wake you up (<i>Customizing Sleep Mode, page 154</i>).
Notifications	Alerts you to incoming calls, texts, social network updates, and more, based on your phone notification settings (<i>Enabling Bluetooth Notifications, page 131</i>).
Performance	Displays performance measurements that help you track and understand your training activities and race performances (<i>Performance Measurements, page 91</i>).
Primary race	Displays the race event you designate as the primary race in your Garmin Connect calendar (<i>Race Calendar and Primary Race, page 75</i>).
Pulse oximeter	Allows you to take a manual pulse oximeter reading (<i>Getting Pulse Oximeter Readings, page 115</i>). If you are too active for the watch to determine your pulse oximeter reading, the measurements are not recorded.
Race calendar	Displays your upcoming race events set in your Garmin Connect calendar (<i>Race Calendar and Primary Race, page 75</i>).
RCT camera controls	Allows you to manually take a photo and record a video clip (<i>Using the Varia Camera Controls, page 122</i>).
Respiration	Your current respiration rate in breaths per minute and seven-day average. You can do a breathing activity to help you relax.
Sleep	Displays total sleep time, a sleep score, and sleep stage information for the previous night.
Steps	Tracks your daily step count, step goal, and data for previous days.
Stocks	Displays a customizable list of stocks (<i>Adding a Stock, page 105</i>).
Stress	Displays your current stress level and a graph of your stress level. You can do a breathing activity to help you relax. If you are too active for the watch to determine your stress level, stress measurements are not recorded.

Name	Description
Sunrise and sunset	Displays sunrise, sunset, dawn, and dusk times, along with a map of the sun's current position and a graph of the day's sunlight.
Surface interval	Displays your surface interval time, oxygen toxicity units (OTU), central nervous system (CNS) oxygen toxicity percentage, and tissue load after a dive (Viewing the Surface Interval Glance, page 21).
Temperature	Displays temperature data from the internal temperature sensor.
Tides	Displays information about a tide station, such as the tide height and when the next high and low tides will occur (Viewing Tide Information, page 45).
Training readiness	Displays a score and a short message that helps you determine how ready you are for training each day (Training Readiness, page 104).
Training status	Displays your current training status and training load, which shows you how your training affects your fitness level and performance (Training Status, page 99).
VIRB® controls	Provides camera controls when you have a VIRB device paired with your Descent watch (VIRB Remote, page 123).
Weather	Displays the current temperature and weather forecast. You can also view the current weather conditions on the map using several map overlays.
Xero® device	Displays laser location information when you have a compatible Xero device paired with your Descent watch (Xero Laser Location Settings, page 124).

Viewing the Glance Loop

Glances provide quick access to health data, activity information, built-in sensors, and more. When you pair your watch, you can view data from your phone, such as notifications, weather, and calendar events.

1 Press **UP** or **DOWN**.

The watch scrolls through the glance loop and displays summary data for each glance.

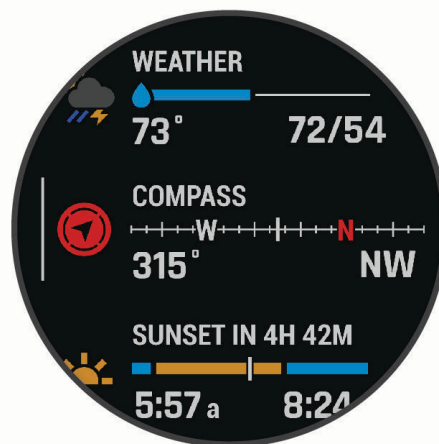

TIP: You can also swipe to scroll or tap to select options.

2 Press **START** to view more information.

3 Select an option:

- Press **DOWN** to view details about a glance.
- Press **START** to view additional options and functions for a glance.

Customizing the Glance Loop

- 1 Hold **MENU**.
- 2 Select **Appearance > Glances**.
- 3 Select an option:
 - To change the location of a glance in the loop, select a glance, and press **UP** or **DOWN**.
 - To remove a glance from the loop, select a glance, and select .
 - To add a glance to the loop, select **Add**, and select a glance.

TIP: You can select **CREATE FOLDER** to create folders that contain multiple glances (*Creating Glance Folders*, page 90).

Creating Glance Folders

You can customize the glance loop to create folders of related glances.

- 1 Hold **MENU**.
- 2 Select **Appearance > Glances > Add > CREATE FOLDER**.
- 3 Select the glances to include in the folder, and select **Done**.

NOTE: If the glances are already in the glance loop, you can move or copy them into the folder.
- 4 Select or enter a name for the folder.
- 5 Select an icon for the folder.
- 6 If necessary, select an option:
 - To edit the folder, scroll to the folder in the glance loop, and hold **MENU**.
 - To edit the glances in the folder, open the folder and select **Edit** (*Customizing the Glance Loop*, page 90).

Body Battery

Your watch analyzes your heart rate variability, stress level, sleep quality, and activity data to determine your overall Body Battery level. Like a gas gauge on a car, it indicates your amount of available reserve energy. The Body Battery level range is from 5 to 100, where 5 to 25 is very low reserve energy, 26 to 50 is low reserve energy, 51 to 75 is medium reserve energy, and 76 to 100 is high reserve energy.

You can sync your watch with your Garmin Connect account to view your most up-to-date Body Battery level, long-term trends, and additional details (*Tips for Improved Body Battery Data*, page 90).

Tips for Improved Body Battery Data

- For more accurate results, wear the watch while sleeping.
- Good sleep charges your Body Battery.
- Strenuous activity and high stress can cause your Body Battery to drain more quickly.
- Food intake, as well as stimulants like caffeine, has no impact on your Body Battery.

Performance Measurements

These performance measurements are estimates that can help you track and understand your training activities and race performances. The measurements require a few activities using wrist-based heart rate or a compatible chest heart rate monitor. Cycling performance measurements require a heart rate monitor and a power meter.

These estimates are provided and supported by Firstbeat Analytics™. For more information, go to garmin.com/performance-data/running.

NOTE: The estimates may seem inaccurate at first. The watch requires you to complete a few activities to learn about your performance.

VO2 max.: VO2 max. is the maximum volume of oxygen (in milliliters) you can consume per minute per kilogram of body weight at your maximum performance (*About VO2 Max. Estimates*, page 92).

Predicted race times: The watch uses the VO2 max. estimate and your training history to provide a target race time based on your current state of fitness (*Viewing Your Predicted Race Times*, page 93).

HRV status: The watch analyzes your wrist heart rate readings while you are sleeping to determine your heart rate variability (HRV) status based on your personal, long-term HRV averages (*Heart Rate Variability Status*, page 94).

Performance condition: Your performance condition is a real-time assessment after 6 to 20 minutes of activity. It can be added as a data field so you can view your performance condition during the rest of your activity. It compares your real-time condition to your average fitness level (*Performance Condition*, page 95).

Functional threshold power (FTP): The watch uses your user profile information from the initial setup to estimate your FTP. For a more accurate rating, you can conduct a guided test (*Getting Your FTP Estimate*, page 96).

Lactate threshold: Lactate threshold requires a chest heart rate monitor. Lactate threshold is the point where your muscles start to rapidly fatigue. Your watch measures your lactate threshold level using heart rate data and pace (*Lactate Threshold*, page 97).

Stamina: The watch uses your VO2 max. estimate and heart rate data to provide real-time stamina estimates. It can be added as a data screen so you can view your potential and current stamina during your activity (*Viewing Your Real-Time Stamina*, page 98).

Power curve (cycling): The power curve displays your sustained power output over time. You can view your power curve for the previous month, three months, or twelve months (*Viewing Your Power Curve*, page 98).

About VO2 Max. Estimates

VO2 max. is the maximum volume of oxygen (in milliliters) you can consume per minute per kilogram of body weight at your maximum performance. In simple terms, VO2 max. is an indication of athletic performance and should increase as your level of fitness improves. The Descent device requires wrist-based heart rate or a compatible chest heart rate monitor to display your VO2 max. estimate. The device has separate VO2 max. estimates for running and cycling. You must run either outside with GPS or ride with a compatible power meter at a moderate level of intensity for several minutes to get an accurate VO2 max. estimate.

On the device, your VO2 max. estimate appears as a number, description, and position on the color gauge. On your Garmin Connect account, you can view additional details about your VO2 max. estimate, such as where it ranks for your age and sex.



 Purple	Superior
 Blue	Excellent
 Green	Good
 Orange	Fair
 Red	Poor

VO2 max. data is provided by Firstbeat Analytics. VO2 max. analysis is provided with permission from The Cooper Institute®. For more information, see the appendix (*VO2 Max. Standard Ratings, page 181*), and go to www.CooperInstitute.org.

Getting Your VO2 Max. Estimate for Running

This feature requires wrist-based heart rate or a compatible chest heart rate monitor. If you are using a chest heart rate monitor, you must put it on and pair it with your watch (*Pairing Your Wireless Sensors, page 120*).

For the most accurate estimate, complete the user profile setup (*Setting Up Your User Profile, page 136*), and set your maximum heart rate (*Setting Your Heart Rate Zones, page 138*). The estimate may seem inaccurate at first. The watch requires a few runs to learn about your running performance. You can disable VO2 max. recording for ultra run and trail run activities if you do not want those run types to affect your VO2 max. estimate (*Activities and App Settings, page 61*).

- 1 Start a running activity.
- 2 Run for at least 10 minutes outdoors.
- 3 After your run, select **Save**.
- 4 Press **UP** or **DOWN** to scroll through the performance measurements.

Getting Your VO2 Max. Estimate for Cycling

This feature requires a power meter and wrist-based heart rate or a compatible chest heart rate monitor. The power meter must be paired with your watch ([Pairing Your Wireless Sensors, page 120](#)). If you are using a chest heart rate monitor, you must put it on and pair it with your watch.

For the most accurate estimate, complete the user profile setup ([Setting Up Your User Profile, page 136](#)) and set your maximum heart rate ([Setting Your Heart Rate Zones, page 138](#)). The estimate may seem inaccurate at first. The watch requires a few rides to learn about your cycling performance.

- 1 Start a cycling activity.
- 2 Ride at a steady, high intensity for at least 20 minutes.
- 3 After your ride, select **Save**.
- 4 Press **UP** or **DOWN** to scroll through the performance measurements.

Viewing Your Predicted Race Times

For the most accurate estimate, complete the user profile setup ([Setting Up Your User Profile, page 136](#)), and set your maximum heart rate ([Setting Your Heart Rate Zones, page 138](#)).

Your watch uses the VO2 max. estimate and your training history to provide a target race time ([About VO2 Max. Estimates, page 92](#)). The watch analyzes several weeks of your training data to refine the race time estimates.

- 1 From the watch face, press **UP** or **DOWN** to view the performance glance.
- 2 Press **START** to view glance details.
- 3 Press **UP** or **DOWN** to view a predicted race time.







- 4 Press **START** to view predictions for other distances.

NOTE: The predictions may seem inaccurate at first. The watch requires a few runs to learn about your running performance.

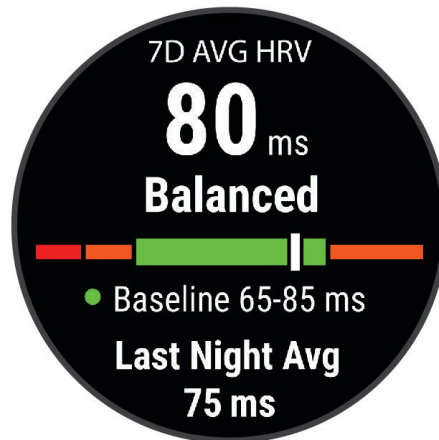
Heart Rate Variability Status

Your watch analyzes your wrist heart rate readings while you are sleeping to determine your heart rate variability (HRV). Training, physical activity, sleep, nutrition, and healthy habits all impact your heart rate variability. HRV values can vary widely based on gender, age, and fitness level. A balanced HRV status may indicate positive signs of health such as good training and recovery balance, greater cardiovascular fitness, and resilience to stress. An unbalanced or poor status may be a sign of fatigue, greater recovery needs, or increased stress. For best results, you should wear the watch while sleeping. The watch requires three weeks of consistent sleep data to display your heart rate variability status.



Color Zone	Status	Description
 Green	Balanced	Your seven-day average HRV is within your baseline range.
 Orange	Unbalanced	Your seven-day average HRV is above or below your baseline range.
 Red	Low	Your seven-day average HRV is well below your baseline range.
No color	Poor No status	Your HRV values are averaging well below the normal range for your age. No status means that there is insufficient data to generate a seven-day average.

You can sync your watch with your Garmin Connect account to view your current heart rate variability status, trends, and educational feedback.

Heart Rate Variability and Stress Level

Stress level is the result of a three-minute test performed while standing still, where the Descent device analyzes heart rate variability to determine your overall stress. Training, sleep, nutrition, and general life stress all impact how a runner performs. The stress level range is from 1 to 100, where 1 is a very low stress state and 100 is a very high stress state. Knowing your stress level can help you decide if your body is ready for a tough training run or yoga.

Viewing Your Heart Rate Variability and Stress Level

This feature requires a Garmin chest heart rate monitor. Before you can view your heart rate variability (HRV) stress level, you must put on a heart rate monitor and pair it with your device ([Pairing Your Wireless Sensors, page 120](#)).

TIP: Garmin recommends that you measure your stress level at approximately the same time and under the same conditions every day.

- 1 If necessary, press **START**, and select **Add > HRV Stress** to add the stress app to the apps list.
- 2 Select **Yes** to add the app to your list of favorites.
- 3 From the watch face, press **START**, select **HRV Stress**, and press **START**.
- 4 Stand still, and rest for 3 minutes.

Performance Condition

As you complete your activity, such as running or cycling, the performance condition feature analyzes your pace, heart rate, and heart rate variability to make a real-time assessment of your ability to perform compared to your average fitness level. It is approximately your real-time percentage deviation from your baseline VO2 max. estimate.

Performance condition values range from -20 to +20. After the first 6 to 20 minutes of your activity, the device displays your performance condition score. For example, a score of +5 means that you are rested, fresh, and capable of a good run or ride. You can add performance condition as a data field to one of your training screens to monitor your ability throughout the activity. Performance condition can also be an indicator of fatigue level, especially at the end of a long training run or ride.

NOTE: The device requires a few runs or rides with a heart rate monitor to get an accurate VO2 max. estimate and learn about your running or riding ability ([About VO2 Max. Estimates, page 92](#)).

Viewing Your Performance Condition

This feature requires wrist-based heart rate or a compatible chest heart rate monitor.

- 1 Add **Performance Condition** to a data screen ([Customizing the Data Screens, page 60](#)).
- 2 Go for a run or ride.
After 6 to 20 minutes, your performance condition appears.
- 3 Scroll to the data screen to view your performance condition throughout the run or ride.

Getting Your FTP Estimate

Before you can get your functional threshold power (FTP) estimate, you must pair a chest heart rate monitor and power meter with your watch ([Pairing Your Wireless Sensors, page 120](#)), and you must get your VO2 max. estimate ([Getting Your VO2 Max. Estimate for Cycling, page 93](#)).

The watch uses your user profile information from the initial setup and your VO2 max. estimate to estimate your FTP. The watch will automatically detect your FTP during rides at a steady, high intensity with heart rate and power.

- 1 Press **UP** or **DOWN** to view the performance glance.
- 2 Press **START** to view glance details.
- 3 Press **UP** or **DOWN** to view your FTP estimate.

Your FTP estimate appears as a value measured in watts per kilogram, your power output in watts, and a position on the color gauge.

 Purple	Superior
 Blue	Excellent
 Green	Good
 Orange	Fair
 Red	Untrained

For more information, see the appendix ([FTP Ratings, page 182](#)).

NOTE: When a performance notification alerts you to a new FTP, you can select Accept to save the new FTP, or Decline to keep your current FTP.

Conducting an FTP Test

Before you can conduct a test to determine your functional threshold power (FTP), you must pair a chest heart rate monitor and a power meter with your device ([Pairing Your Wireless Sensors, page 120](#)), and you must get your VO2 max. estimate ([Getting Your VO2 Max. Estimate for Cycling, page 93](#)).

NOTE: The FTP test is a challenging workout that takes about 30 minutes to complete. Choose a practical and mostly flat route that allows you to ride at a steadily increasing effort, similar to a time trial.

- 1 From the watch face, select **START**.
- 2 Select a cycling activity.
- 3 Hold **MENU**.
- 4 Select **Training > Workout Library > FTP Guided Test**.

- 5 Follow the on-screen instructions.

After you begin your ride, the device displays each step duration, the target, and current power data. A message appears when the test is complete.

- 6 After you complete the guided test, complete the cool down, stop the timer, and save the activity.

Your FTP appears as a value measured in watts per kilogram, your power output in watts, and a position on the color gauge.

- 7 Select an option:
 - Select **Accept** to save the new FTP.
 - Select **Decline** to keep your current FTP.

Lactate Threshold

Lactate threshold is the exercise intensity at which lactate (lactic acid) starts to accumulate in the bloodstream. In running, this intensity level is estimated in terms of pace, heart rate, or power. When a runner exceeds the threshold, fatigue starts to increase at an accelerating rate. For experienced runners, the threshold occurs at approximately 90% of their maximum heart rate and between 10 km and half-marathon race pace. For average runners, the lactate threshold often occurs well below 90% of maximum heart rate. Knowing your lactate threshold can help you determine how hard to train or when to push yourself during a race.

If you already know your lactate threshold heart rate value, you can enter it in your user profile settings ([Setting Your Heart Rate Zones, page 138](#)). You can turn on the **Auto Detection** feature to automatically record your lactate threshold during an activity.

Performing a Guided Test to Determine Your Lactate Threshold

This feature requires a Garmin chest heart rate monitor. Before you can perform the guided test, you must put on a heart rate monitor and pair it with your watch ([Pairing Your Wireless Sensors, page 120](#)).

The watch uses your user profile information from the initial setup and your VO2 max. estimate to estimate your lactate threshold. The watch will automatically detect your lactate threshold during runs at a steady, high intensity with heart rate.

TIP: The watch requires a few runs with a chest heart rate monitor to get an accurate maximum heart rate value and VO2 max. estimate. If you are having trouble getting a lactate threshold estimate, try manually lowering your maximum heart rate value.

- 1 From the watch face, press **START**.
- 2 Select an outdoor running activity.
GPS is required to complete the test.
- 3 Hold **MENU**.
- 4 Select **Training > Workout Library > Lactate Threshold Guided Test**.
- 5 Press **START** to start the activity timer, and follow the on-screen instructions.
After you begin your run, the watch displays each step duration, the target, and current heart rate data. A message appears when the test is complete.
- 6 After you complete the guided test, stop the activity timer and save the activity.
If this is your first lactate threshold estimate, the watch prompts you to update your heart rate zones based on your lactate threshold heart rate. For each additional lactate threshold estimate, the watch prompts you to accept or decline the estimate.

Viewing Your Real-Time Stamina

Your watch can provide real-time stamina estimates based on your heart rate data and VO2 max. estimate ([About VO2 Max. Estimates, page 92](#)).

- 1 Hold **MENU**.
- 2 Select **Activities & Apps**.
- 3 Select a run or bike activity.
- 4 Select the activity settings.
- 5 Select **Data Screens > Add New > Stamina**.
- 6 Press **UP** or **DOWN** to change the location of the data screen (optional).
- 7 Press **START** to edit the primary stamina data field (optional).
- 8 Start your activity ([Starting an Activity, page 32](#)).
- 9 Press **UP** or **DOWN** to scroll to the data screen.

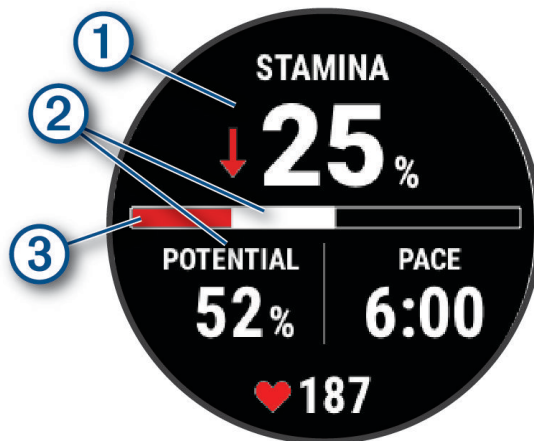

① Primary stamina data field. Shows your current stamina percentage, distance remaining, or time remaining.

② Potential stamina.

Current stamina.

- ③
- Red: Stamina is depleting.
 - Orange: Stamina is steady.
 - Green: Stamina is recharging.

Viewing Your Power Curve

Before you can view your power curve, you must record a ride that's at least one hour long using a power meter in the last 90 days ([Pairing Your Wireless Sensors, page 120](#)).

You can create workouts in your Garmin Connect account. The power curve displays your sustained power output over time. You can view your power curve for the previous month, three months, or twelve months.

- 1 From the Garmin Connect app, select **•••**.
- 2 Select **Performance Stats > Power Curve**.

Training Status

These measurements are estimates that can help you track and understand your training activities. The measurements require you to complete activities for two weeks using wrist-based heart rate or a compatible chest heart rate monitor. Cycling performance measurements require a heart rate monitor and a power meter. The measurements may seem inaccurate at first when the watch is still learning about your performance.

These estimates are provided and supported by Firstbeat Analytics. For more information, go to garmin.com/performance-data/running.



Training status: Training status shows you how your training affects your fitness and performance. Your training status is based on changes to your VO2 max., acute load, and HRV status over an extended time period.

VO2 max.: VO2 max. is the maximum volume of oxygen (in milliliters) you can consume per minute per kilogram of body weight at your maximum performance (*About VO2 Max. Estimates, page 92*). Your watch displays heat and altitude corrected VO2 max. values when you are acclimating to high heat environments or high altitude (*Heat and Altitude Performance Acclimation, page 103*).

HRV: HRV is your heart rate variability status over the last seven days (*Heart Rate Variability Status, page 94*).

Acute load: Acute load is a weighted sum of your recent exercise load scores including exercise duration and intensity. (*Acute Load, page 100*).

Training load focus: Your watch analyzes and distributes your training load into different categories based on the intensity and structure of each activity recorded. Training load focus includes the total load accumulated per category, and the focus of the training. Your watch displays your load distribution over the last 4 weeks (*Training Load Focus, page 101*).

Recovery time: The recovery time displays how much time remains before you are fully recovered and ready for the next hard workout (*Recovery Time, page 102*).

Training Status Levels

Training status shows you how your training affects your fitness level and performance. Your training status is based on changes to your VO2 max., acute load, and HRV status over an extended time period. You can use your training status to help plan future training and continue improving your fitness level.

No Status: The watch needs you to record multiple activities over two weeks, with VO2 max. results from running or cycling, to determine your training status.

Detraining: You have a break in your training routine or you are training much less than usual for a week or more. Detraining means that you are unable to maintain your fitness level. You can try increasing your training load to see improvement.

Recovery: Your lighter training load is allowing your body to recover, which is essential during extended periods of hard training. You can return to a higher training load when you feel ready.

Maintaining: Your current training load is enough to maintain your fitness level. To see improvement, try adding more variety to your workouts or increasing your training volume.

Productive: Your current training load is moving your fitness level and performance in the right direction. You should plan recovery periods into your training to maintain your fitness level.

Peaking: You are in ideal race condition. Your recently reduced training load is allowing your body to recover and fully compensate for earlier training. You should plan ahead, since this peak state can only be maintained for a short time.

Overreaching: Your training load is very high and counterproductive. Your body needs a rest. You should give yourself time to recover by adding lighter training to your schedule.

Unproductive: Your training load is at a good level, but your fitness is decreasing. Try focusing on rest, nutrition, and stress management.

Strained: There is imbalance between your recovery and training load. It is a normal result after a hard training or major event. Your body may be struggling to recover, so you should pay attention to your overall health.

Tips for Getting Your Training Status

The training status feature depends on updated assessments of your fitness level, including at least one VO2 max. measurement per week ([About VO2 Max. Estimates, page 92](#)). Indoor run activities do not generate a VO2 max. estimate in order to preserve the accuracy of your fitness level trend. You can disable VO2 max. recording for ultra run and trail run activities if you do not want those run types to affect your VO2 max. estimate ([Activities and App Settings, page 61](#)).

To get the most out of the training status feature, you can try these tips.

- At least one time per week, run or ride outdoors with a power meter, and reach a heart rate higher than 70% of your maximum heart rate for at least 10 minutes.
After using the watch for one or two weeks, your training status should be available.
- Record all of your fitness activities on your primary training device, allowing your watch to learn about your performance ([Syncing Activities and Performance Measurements, page 75](#)).
- Wear the watch consistently while you sleep, to continue generating an up-to-date HRV status. Having a valid HRV status can help maintain a valid training status when you do not have as many activities with VO2 max. measurements.

Acute Load

Acute load is a weighted sum of your excess post-exercise oxygen consumption (EPOC) for the last several days. The gauge indicates whether your current load is low, optimal, high, or very high. The optimal range is based on your individual fitness level and training history. The range adjusts as your training time and intensity increase or decrease.

Training Load Focus

In order to maximize performance and fitness gains, training should be distributed across three categories: low aerobic, high aerobic, and anaerobic. Training load focus shows you how much of your training is currently in each category and provides training targets. Training load focus requires at least 7 days of training to determine if your training load is low, optimal, or high. After 4 weeks of training history, your training load estimate will have more detailed target information to help you balance your training activities.

Below targets: Your training load is lower than optimal in all intensity categories. Try increasing the duration or frequency of your workouts.

Low aerobic shortage: Try adding more low aerobic activities to provide recovery and balance for your higher intensity activities.

High aerobic shortage: Try adding more high aerobic activities to help improve your lactate threshold and VO2 max. over time.

Anaerobic shortage: Try adding a few more intense, anaerobic activities to improve your speed and anaerobic capacity over time.

Balanced: Your training load is balanced and provides all-around fitness benefits as you continue training.

Low aerobic focus: Your training load is mostly low aerobic activity. This provides a solid foundation and prepares you for adding more intense workouts.

High aerobic focus: Your training load is mostly high aerobic activity. These activities help to improve lactate threshold, VO2 max., and endurance.

Anaerobic focus: Your training load is mostly intense activity. This leads to rapid fitness gains, but should be balanced with low aerobic activities.

Above targets: Your training load is higher than optimal, and you should consider scaling back the duration and frequency of your workouts.

Load Ratio

Load ratio is the ratio of your acute (short-term) training load to your chronic (long-term) training load. It's helpful for tracking your training load changes.

Status	Value	Description
No Status	None	Load ratio will be visible after 2 weeks of training.
Low	Lower than 0.8	Your short-term training load is lower than your long-term training load.
Optimal 	0.8 to 1.4	The short-term and long-term training loads are balanced. The optimal range is based on your individual fitness level and training history.
High	1.5 to 1.9	Your short-term training load is higher than your long-term training load.
Very High	2.0 or higher	Your short-term training load is significantly higher than your long-term training load.

About Training Effect

Training Effect measures the impact of an activity on your aerobic and anaerobic fitness. Training Effect accumulates during the activity. As the activity progresses, the Training Effect value increases. Training Effect is determined by your user profile information and training history, and heart rate, duration, and intensity of your activity. There are seven different Training Effect labels to describe the primary benefit of your activity. Each label is color coded and corresponds to your training load focus (*Training Load Focus, page 101*). Each feedback phrase, for example, "Highly Impacting VO2 Max." has a corresponding description in your Garmin Connect activity details.

Aerobic Training Effect uses your heart rate to measure how the accumulated intensity of an exercise affects your aerobic fitness and indicates if the workout had a maintaining or improving effect on your fitness level. Your excess post-exercise oxygen consumption (EPOC) accumulated during exercise is mapped to a range of values that account for your fitness level and training habits. Steady workouts at moderate effort or workouts involving longer intervals (>180 sec) have a positive impact on your aerobic metabolism and result in an improved aerobic Training Effect.

Anaerobic Training Effect uses heart rate and speed (or power) to determine how a workout affects your ability to perform at very high intensity. You receive a value based on the anaerobic contribution to EPOC and the type of activity. Repeated high-intensity intervals of 10 to 120 seconds have a highly beneficial impact on your anaerobic capability and result in an improved anaerobic Training Effect.

You can add Aerobic Training Effect and Anaerobic Training Effect as data fields to one of your training screens to monitor your numbers throughout the activity.

Training Effect	Aerobic Benefit	Anaerobic Benefit
From 0.0 to 0.9	No benefit.	No benefit.
From 1.0 to 1.9	Minor benefit.	Minor benefit.
From 2.0 to 2.9	Maintains your aerobic fitness.	Maintains your anaerobic fitness.
From 3.0 to 3.9	Impacts your aerobic fitness.	Impacts your anaerobic fitness.
From 4.0 to 4.9	Highly impacts your aerobic fitness.	Highly impacts your anaerobic fitness.
5.0	Overreaching and potentially harmful without enough recovery time.	Overreaching and potentially harmful without enough recovery time.

Training Effect technology is provided and supported by Firstbeat Analytics. For more information, go to firstbeat.com.

Recovery Time

You can use your Garmin device with wrist-based heart rate or a compatible chest heart rate monitor to display how much time remains before you are fully recovered and ready for the next hard workout.

NOTE: The recovery time recommendation uses your VO2 max. estimate and may seem inaccurate at first. The device requires you to complete a few activities to learn about your performance.

The recovery time appears immediately following an activity. The time counts down until it is optimal for you to attempt another hard workout. The device updates your recovery time throughout the day based on changes in sleep, stress, relaxation, and physical activity.

Recovery Heart Rate

If you are training with wrist-based heart rate or a compatible chest heart rate monitor, you can check your recovery heart rate value after each activity. Recovery heart rate is the difference between your exercising heart rate and your heart rate two minutes after the exercise has stopped. For example, after a typical training run, you stop the timer. Your heart rate is 140 bpm. After two minutes of no activity or cool down, your heart rate is 90 bpm. Your recovery heart rate is 50 bpm (140 minus 90). Some studies have linked recovery heart rate to cardiac health. Higher numbers generally indicate healthier hearts.

TIP: For best results, you should stop moving for two minutes while the device calculates your recovery heart rate value.

Heat and Altitude Performance Acclimation

Environmental factors such as high temperature and altitude impact your training and performance. For example, high altitude training can have a positive impact on your fitness, but you may notice a temporary VO2 max. decline while exposed to high altitudes. Your Descent watch provides acclimation notifications and corrections to your VO2 max. estimate and training status when the temperature is above 22°C (72°F) and when the altitude is above 800 m (2625 ft.). You can keep track of your heat and altitude acclimation in the training status glance.

NOTE: The heat acclimation feature is available only for GPS activities and requires weather data from your connected phone.

Pausing and Resuming Your Training Status

If you are injured or sick, you can pause your training status. You can continue to record fitness activities, but your training status, training load focus, recovery feedback, and workout recommendations are temporarily disabled.





You can resume your training status when you are ready to start training again. For best results, you need at least one VO2 max. measurement each week ([About VO2 Max. Estimates, page 92](#)).

- 1 When you want to pause your training status, select an option:
 - From the training status glance, hold **MENU**, and select **Options > Pause Training Status**.
 - From your Garmin Connect settings, select **Performance Stats > Training Status > ⋮ > Pause Training Status**.
- 2 Sync your watch with your Garmin Connect account.
- 3 When you want to resume your training status, select an option:
 - From the training status glance, hold **MENU**, and select **Options > Resume Training Status**.
 - From your Garmin Connect settings, select **Performance Stats > Training Status > ⋮ > Resume Training Status**.
- 4 Sync your watch with your Garmin Connect account.

Training Readiness

Your training readiness is a score and a short message that helps you determine how ready you are for training each day. The score is continuously calculated and updated throughout the day using these factors:

- Sleep score (last night)
- Recovery time
- HRV status
- Acute load
- Sleep history (last 3 nights)
- Stress history (last 3 days)

Color Zone	Score	Description
 Purple	95 to 100	Prime Best possible
 Blue	75 to 94	High Ready for challenges
 Green	50 to 74	Moderate Good to go
 Orange	25 to 49	Low Time to slow down
 Red	1 to 24	Poor Let your body recover

To see your training readiness trends over time, go to your Garmin Connect account.

Endurance Score

Your endurance score helps you understand your overall endurance based on all recorded activities with heart rate data. You can view recommendations for improving your endurance score, and the top sports contributing to your score over time.

Color Zone	Description
 Pink	Elite
 Purple	Superior
 Blue	Expert
 Green	Well Trained
 Yellow	Trained
 Orange	Intermediate
 Red	Recreational

For more information, see the appendix ([Endurance Score Ratings, page 183](#)).

Hill Score

Your hill score helps you understand your current capacity for uphill running based on your training history and VO2 max. estimate. Your watch detects uphill segments with 2% grade or more during an outdoor running activity. You can view your hill endurance, hill strength, and changes to your hill score over time.

Color Zone	Score	Description
 Pink	95 to 100	Elite
 Purple	85 to 94	Expert
 Blue	70 to 84	Skilled
 Green	50 to 69	Trained
 Orange	25 to 49	Challenger
 Red	1 to 24	Recreational

Viewing Cycling Ability

Before you can view your cycling ability, you must have a 7-day training history, VO2 max. data recorded in your user profile ([About VO2 Max. Estimates, page 92](#)), and power curve data from a paired power meter ([Viewing Your Power Curve, page 98](#)).

Cycling ability is a measurement of your performance across three categories: aerobic endurance, aerobic capacity, and anaerobic capacity. Cycling ability includes your current rider type, such as climber. Information you enter in your user profile, such as body weight, also helps determine your rider type ([Setting Up Your User Profile, page 136](#)).

- 1 Press **UP** or **DOWN** to view the cycling ability glance.
NOTE: You may need to add the glance to your glance loop ([Customizing the Glance Loop, page 90](#)).
- 2 Press **START** to view your current rider type.
- 3 Press **START** to view a detailed analysis of your cycling ability (optional).

Adding a Stock

Before you can customize the stocks list, you must add the stocks glance to the glance loop ([Customizing the Glance Loop, page 90](#)).

- 1 From the watch face, press **UP** or **DOWN** to view the stocks glance.
- 2 Press **START**.
- 3 Select **Add Stock**.
- 4 Enter the company name or stock symbol for the stock you want to add, and select .
The watch displays search results.
- 5 Select the stock you want to add.
- 6 Select the stock to view more information.
TIP: To display the stock on the glance loop, you can press **START**, and select Set as Favorite.

Adding Weather Locations

- 1 From the watch face, press **UP** or **DOWN** to view the weather glance.
- 2 Press **START**.
- 3 On the first glance screen, press **START**.
- 4 Select **Add Location**, and search for a location.
- 5 If necessary, repeat steps 3 and 4 to add more locations.
- 6 Press **START**, and select a location to show the weather for that location.

Using the Jet Lag Adviser

Before you can use the Jet Lag Adviser glance, you must plan a trip in the Garmin Connect app (*Planning a Trip in the Garmin Connect App*, page 106).

You can use the Jet Lag Adviser glance while traveling to see how your internal clock compares to the local time, and to receive guidance on how to reduce the effects of jet lag.

- 1 From the watch face, press **UP** or **DOWN** to view the **Jet Lag Adviser** glance.
- 2 Press **START** to see how your internal clock compares to the local time, and the overall level of your jet lag.
- 3 Select an option:
 - To see an informational message about your current jet lag level, press **START**.
 - To see a timeline for recommended actions to help reduce symptoms of jet lag, press **DOWN**.

Planning a Trip in the Garmin Connect App



















- 1 From the Garmin Connect app, select **•••**.
- 2 Select **Training & Planning > Jet Lag Adviser > Add Trip Details**.
- 3 Follow the on-screen instructions.





















Controls





The controls menu lets you quickly access watch features and options. You can add, reorder, and remove the options in the controls menu (*Customizing the Controls Menu*, page 109).

From any screen, hold **LIGHT**.



Icon	Name	Description
	ABC	Select to open the altimeter, barometer, and compass app.
	Airplane Mode	Select to enable or disable airplane mode to turn off all wireless communications.
	Alarm Clock	Select to add or edit an alarm (Setting an Alarm, page 30).
	Altimeter	Select to open the altimeter screen.
	Alt. Time Zones	Select to view the current time of day in additional time zones (Adding Alternate Time Zones, page 31).
	Applied Ballistics	Select to open the Applied Ballistics app (Applied Ballistics®, page 67).
	Assistance	Select to send an assistance request (Requesting Assistance, page 141).
	Barometer	Select to open the barometer screen.
	Battery Saver	Select to enable or disable the battery saver feature (Customizing the Battery Saver Feature, page 151).
	Brightness	Select to adjust the screen brightness (Changing the Screen Settings, page 153).
	Broadcast Heart Rate	Select to turn on heart rate broadcasting to a paired device (Broadcasting Heart Rate Data, page 113).
	Calendar	Select to view upcoming events from your phone calendar.
	Clocks	Select to open the Clocks app to set an alarm, timer, stopwatch, or view alternate time zones (Clocks, page 30).
	Compass	Select to open the compass screen.
	Display	Turns off the screen for alerts, gestures, and Always On Display mode (Changing the Screen Settings, page 153).
	Do Not Disturb	Select to enable or disable do not disturb mode to dim the screen and disable alerts and notifications. For example, you can use this mode while watching a movie.
	Find My Phone	Select to play an audible alert on your paired phone, if it is within Bluetooth range. The Bluetooth signal strength appears on the Descent watch screen, and it increases as you move closer to your phone.
	Flashlight	Select to turn on the screen to use your watch as a flashlight. On the Descent Mk3i - 51 mm watch, the LED flashlight turns on.
	History	Select to view your activity history, records, and totals.
	Kill Switch	Select to quickly remove all saved user data and reset all settings to the factory default values.

Icon	Name	Description
	Lock Device	Select to lock the buttons and the touchscreen to prevent inadvertent presses and swipes.
	Moon Phase	Select to view moonrise and moonset times, along with the moon phase, based on your GPS position.
	Music Controls	Select to control music playback on your watch or phone.
	Night Vision	Select to adjust the screen for compatibility with night vision goggles and disable the wrist heart rate monitor.
	Notifications	Select to view calls, texts, social network updates, and more, based on your phone notification settings (Enabling Bluetooth Notifications, page 131).
	Phone	Select to enable or disable Bluetooth technology and your connection to your paired phone.
	Pool Mode	Select to enable or disable the pool mode for diving. When the watch is in pool dive mode, the tissue load and decompression lockout features function normally, but dives are not saved to the dive log. The pool dive mode turns off automatically at midnight.
	Power Off	Select to turn off the watch.
	Pulse Ox	Select to open the pulse oximeter app (Pulse Oximeter, page 114).
	Red Shift	Select to turn the screen to shades of red to use the watch in low light conditions.
	Reference Point	Select to set a reference point for navigation (Setting a Reference Point, page 144).
	Save Location	Select to save your current location to navigate back to it later.
	Settings	Select to open the settings menu.
	Sleep Mode	Select to enable or disable Sleep Mode (Customizing Sleep Mode, page 154).
	Stealth Mode	Select to enable or disable stealth mode to turn off wireless communications and prevent the storage and sharing of your GPS position.
	Stopwatch	Select to start the stopwatch (Using the Stopwatch, page 31).
	Strobe	Select to turn on the LED flashlight strobe. You can create a custom strobe mode (Editing the Custom Flashlight Strobe, page 110). NOTE: This feature is not available for all product models.
	Sunrise & Sunset	Select to view sunrise, sunset, and twilight times.
	Sync	Select to sync your watch with your paired phone.
	Time Sync	Select to sync your watch with the time on your phone or using satellites.

Icon	Name	Description
	Timers	Select to set a countdown timer (Starting the Countdown Timer, page 30).
	Touch	Select to enable or disable touchscreen controls.
	Wallet	Select to open your Garmin Pay™ wallet and pay for purchases with your watch (Garmin Pay, page 110).
	Weather	Select to view the current weather forecast and current conditions.
	Wi-Fi	Select to enable or disable Wi-Fi® communications.

Customizing the Controls Menu

You can add, remove, and change the order of the shortcut menu options in the controls menu ([Controls, page 106](#)).

- 1 Hold **MENU**.
- 2 Select **Appearance > Controls**.
- 3 Select a shortcut to customize.
- 4 Select an option:
 - Select **Reorder** to change the location of the shortcut in the controls menu.
 - Select **Remove** to remove the shortcut from the controls menu.
- 5 If necessary, select **Add New** to add an additional shortcut to the controls menu.

Using the LED Flashlight

WARNING

This device may have a flashlight that can be programmed to flash at various intervals. Consult your physician if you have epilepsy or are sensitive to bright or flashing lights.

NOTE: This feature is only available for Descent Mk3i - 51 mm models.



Using the flashlight can reduce battery life. You can reduce the brightness to extend the life of the battery.

- 1 Hold **LIGHT**.
- 2 Select .
- 3 If necessary, press **START** to turn on the flashlight.
- 4 Select an option:
 - To adjust the brightness or color of the flashlight, press **UP** or **DOWN**.
TIP: You can quickly press **LIGHT** twice to turn on the flashlight at this setting in the future.
 - To program the flashlight to flash in a selected pattern, hold **MENU**, select **Strobe**, select a mode, and press **START**.
 - To display your emergency contact information and program the flashlight to flash in a distress pattern, hold **MENU**, select **Distress Pattern**, and press **START**.

CAUTION

Programming the flashlight to flash in a distress pattern will not contact your emergency contacts or emergency services on your behalf. Your emergency contact information will only appear if it has been configured in the Garmin Connect app.

Editing the Custom Flashlight Strobe

- 1 Hold **LIGHT**.
- 2 Select  > **CUSTOM**.
- 3 Press **START** to turn on the flashlight strobe (optional).
- 4 Select .
- 5 Press **UP** or **DOWN** to scroll to a strobe setting.
- 6 Press **START** to scroll through the setting options.
- 7 Press **BACK** to save.

Using the Flashlight Screen

NOTE: This feature is only available for Descent Mk3/Mk3i - 43 mm models.

Using the flashlight can reduce battery life. You can reduce the brightness to extend the life of the battery.

- 1 Hold **LIGHT**.
- 2 Select .
- 3 Press **UP** or **DOWN** to adjust the brightness and color.

TIP: You can quickly press **LIGHT** twice to turn on the flashlight at this setting in the future.

Garmin Pay

The Garmin Pay feature allows you to use your watch to pay for purchases in participating locations using credit or debit cards from a participating financial institution.

Setting Up Your Garmin Pay Wallet

You can add one or more participating credit or debit cards to your Garmin Pay wallet. Go to garmin.com/garminpay/banks to find participating financial institutions.

- 1 From the Garmin Connect app, select .
- 2 Select **Garmin Pay > Get Started**.
- 3 Follow the on-screen instructions.

Paying for a Purchase Using Your Watch

Before you can use your watch to pay for purchases, you must set up at least one payment card.

You can use your watch to pay for purchases in a participating location.

- 1 Hold **LIGHT**.
- 2 Select .
- 3 Enter your four-digit passcode.

NOTE: If you enter your passcode incorrectly three times, your wallet locks, and you must reset your passcode in the Garmin Connect app.

Your most recently used payment card appears.

- 4 If you have added multiple cards to your Garmin Pay wallet, swipe to change to another card (optional).
- 5 If you have added multiple cards to your Garmin Pay wallet, select **DOWN** to change to another card (optional).
- 6 Within 60 seconds, hold your watch near the payment reader, with the watch facing the reader.
The watch vibrates and displays a check mark when it is finished communicating with the reader.
- 7 If necessary, follow the instructions on the card reader to complete the transaction.

TIP: After you successfully enter your passcode, you can make payments without a passcode for 24 hours while you continue to wear your watch. If you remove the watch from your wrist or disable heart rate monitoring, you must enter the passcode again before making a payment.

Adding a Card to Your Garmin Pay Wallet

You can add up to 10 credit or debit cards to your Garmin Pay wallet.

- 1 From the Garmin Connect app, select ●●●.
- 2 Select **Garmin Pay** >  > **Add Card**.
- 3 Follow the on-screen instructions.

After the card is added, you can select the card on your watch when you make a payment.

Managing Your Garmin Pay Cards

You can temporarily suspend or delete a card.

NOTE: In some countries, participating financial institutions may restrict the Garmin Pay features.

- 1 From the Garmin Connect app, select ●●●.
- 2 Select **Garmin Pay**.
- 3 Select a card.
- 4 Select an option:
 - To temporarily suspend or unsuspend the card, select **Suspend Card**.
The card must be active to make purchases using your Descent watch.
 - To delete the card, select .

Changing Your Garmin Pay Passcode

You must know your current passcode to change it. If you forget your passcode, you must reset the Garmin Pay feature for your Descent watch, create a new passcode, and reenter your card information.

- 1 From the Garmin Connect app, select ●●●.
- 2 Select **Garmin Pay** > **Change Passcode**.
- 3 Follow the on-screen instructions.

The next time you pay using your Descent watch, you must enter the new passcode.

Morning Report

Your watch displays a morning report based on your normal wake time. Press **DOWN** to view the report, which includes weather, sleep, overnight heart rate variability status, and more ([Customizing Your Morning Report, page 111](#)).

Customizing Your Morning Report

NOTE: You can customize these settings on you watch or in your Garmin Connect account.

- 1 Hold **MENU**.
- 2 Select **Appearance** > **Morning Report**.
- 3 Select an option:
 - Select **Show Report** to enable or disable the morning report.
 - Select **Edit Report** to customize the order and type of data that appears in your morning report.

Sensors and Accessories

The Descent watch has several internal sensors, and you can pair additional wireless sensors for your activities.

Wrist Heart Rate

Your watch has a wrist-based heart rate monitor, and you can view your heart rate data on the heart rate glance ([Viewing the Glance Loop, page 89](#)).

The watch is also compatible with chest heart rate monitors. If both wrist-based heart rate and chest heart rate data are available when you start an activity, your watch uses the chest heart rate data.

Wearing the Watch

⚠ CAUTION

Some users may experience skin irritation after prolonged use of the watch, especially if the user has sensitive skin or allergies. If you notice any skin irritation, remove the watch and give your skin time to heal. To help prevent skin irritation, ensure the watch is clean and dry, and do not overtighten the watch on your wrist. For more information, go to garmin.com/fitandcare.

- Wear the watch above your wrist bone.

NOTE: The watch should be snug but comfortable. For more accurate heart rate readings, the watch should not shift while running or exercising. For pulse oximeter readings, you should remain motionless.

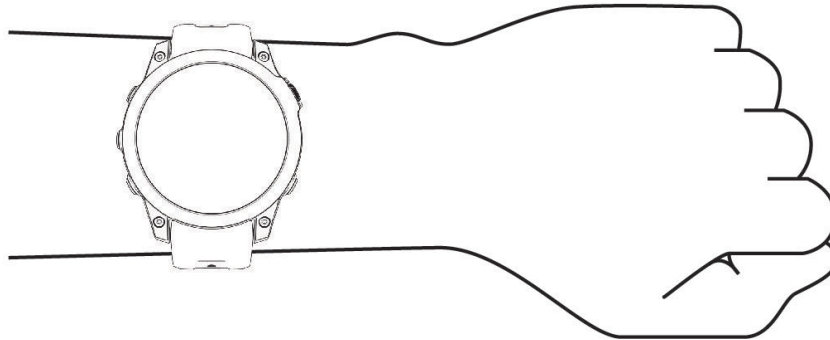

NOTE: While diving, the watch should stay in contact with your skin, and it should not bump into other wrist-worn devices.

NOTE: The optical sensor is located on the back of the watch.

- See [Tips for Erratic Heart Rate Data, page 112](#) for more information about wrist-based heart rate.
- See [Tips for Erratic Pulse Oximeter Data, page 115](#) for more information about the pulse oximeter sensor.
- For more information about accuracy, go to garmin.com/ataccuracy.
- For more information about watch wear and care, go to garmin.com/fitandcare.

Tips for Erratic Heart Rate Data

If the heart rate data is erratic or does not appear, you can try these tips.

- Clean and dry your arm before putting on the watch.
- Avoid wearing sunscreen, lotion, and insect repellent under the watch.
- Avoid scratching the heart rate sensor on the back of the watch.
- Wear the watch above your wrist bone. The watch should be snug but comfortable.
- Wait until the ❤ icon is solid before starting your activity.
- Warm up for 5 to 10 minutes and get a heart rate reading before starting your activity.

NOTE: In cold environments, warm up indoors.

- Rinse the watch with fresh water after each workout.

Wrist Heart Rate Monitor Settings

Hold **MENU**, and select **Sensors & Accessories > Wrist Heart Rate**.

Status: Enables or disables the wrist heart rate monitor. The default value is Auto, which automatically uses the wrist heart rate monitor unless you pair an external heart rate monitor.

NOTE: Disabling the wrist heart rate monitor also disables the wrist-based pulse oximeter sensor. You can perform a manual reading from the pulse oximeter glance.

While Swimming: Enables or disables the wrist heart rate monitor during swimming activities.

Abnormal Heart Rate Alerts: Allows you to set the watch to alert you when your heart rate exceeds or drops below a target value ([Setting an Abnormal Heart Rate Alert, page 113](#)).

Broadcast Heart Rate: Allows you to begin broadcasting your heart rate data to a paired device ([Broadcasting Heart Rate Data, page 113](#)).

Setting an Abnormal Heart Rate Alert

CAUTION

This feature only alerts you when your heart rate exceeds or drops below a certain number of beats per minute, as selected by the user, after a period of inactivity. This feature does not notify you of any potential heart condition and is not intended to treat or diagnose any medical condition or disease. Always defer to your health care provider for any heart-related issues.

You can set the heart rate threshold value.

- 1 Hold **MENU**.
- 2 Select **Sensors & Accessories > Wrist Heart Rate > Abnormal Heart Rate Alerts**.
- 3 Select **High Alert** or **Low Alert**.
- 4 Set the heart rate threshold value.

Each time your heart rate exceeds or drops below the threshold value, a message appears and the watch vibrates.

Broadcasting Heart Rate Data

You can broadcast your heart rate data from your watch and view it on paired devices. Broadcasting heart rate data decreases battery life.

TIP: You can customize the activity settings to broadcast your heart rate data automatically when you begin an activity ([Activities and App Settings, page 61](#)). For example, you can broadcast your heart rate data to an Edge device while cycling.

NOTE: Broadcasting heart rate data is not available for dive activities.

- 1 Select an option:
 - Hold **MENU**, and select **Sensors & Accessories > Wrist Heart Rate > Broadcast Heart Rate**.
 - Hold **LIGHT** to open the controls menu, and select .

NOTE: You can add options to the controls menu ([Customizing the Controls Menu, page 109](#)).

- 2 Press **START**.

The watch starts broadcasting your heart rate data.

- 3 Pair your watch with your compatible device.

NOTE: The pairing instructions differ for each Garmin compatible device. See your owner's manual.

- 4 Press **STOP** to stop broadcasting your heart rate data.

Pulse Oximeter

Your watch has a wrist-based pulse oximeter to gauge the peripheral saturation of oxygen in your blood (SpO₂). As your altitude increases, the level of oxygen in your blood can decrease. Knowing your oxygen saturation can help you determine how your body is acclimating to high altitudes for alpine sport and expedition.

You can manually begin a pulse oximeter reading by viewing the pulse oximeter glance (*Getting Pulse Oximeter Readings, page 115*). You can also turn on all-day readings (*Setting the Pulse Oximeter Mode, page 115*). When you view the pulse oximeter glance while you are not moving, your watch analyzes your oxygen saturation and your elevation. The elevation profile helps indicate how your pulse oximeter readings are changing, relative to your to elevation.

On the watch, your pulse oximeter reading appears as an oxygen saturation percentage and color on the graph. On your Garmin Connect account, you can view additional details about your pulse oximeter readings, including trends over multiple days.

For more information about pulse oximeter accuracy, go to garmin.com/ataccuracy.

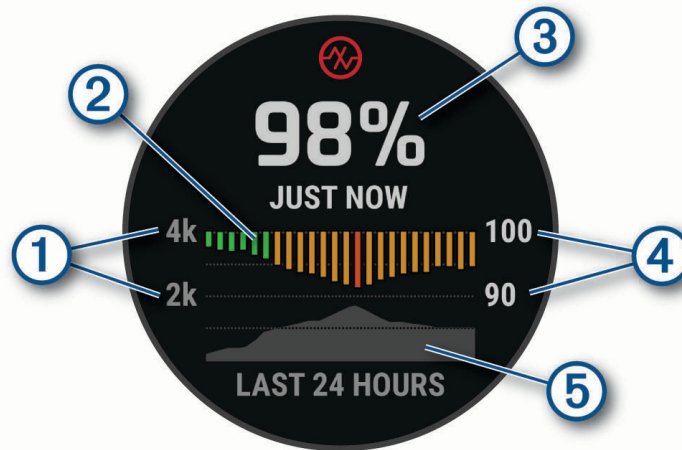

①	The elevation scale.
②	A graph of your average oxygen saturation readings for the last 24 hours.
③	Your most recent oxygen saturation reading.
④	The oxygen saturation percentage scale.
⑤	A graph of your elevation readings for the last 24 hours.

Getting Pulse Oximeter Readings

You can manually begin a pulse oximeter reading by viewing the pulse oximeter glance. The glance displays your most recent blood oxygen saturation percentage, a graph of your hourly average readings for the last 24 hours, and a graph of your elevation for the last 24 hours.

NOTE: The first time you view the pulse oximeter glance, the watch must acquire satellite signals to determine your elevation. You should go outside, and wait while the watch locates satellites.

- 1 While you are sitting or inactive, press **UP** or **DOWN** to view the pulse oximeter glance.
- 2 Press **START** to view glance details and begin a pulse oximeter reading.
- 3 Remain motionless for up to 30 seconds.

NOTE: If you are too active for the watch to get a pulse oximeter reading, a message appears instead of a percentage. You can check again after several minutes of inactivity. For best results, hold the arm wearing the watch at heart level while the watch reads your blood oxygen saturation.

- 4 Press **DOWN** to view a graph of your pulse oximeter readings for the last seven days.

Setting the Pulse Oximeter Mode

- 1 Hold **MENU**.
- 2 Select **Sensors & Accessories > Pulse Oximeter > Pulse Ox Mode**.
- 3 Select an option:
 - To turn off automatic measurements, select **Manual Check**.
 - To turn on continuous measurements while you sleep, select **During Sleep**.
NOTE: Unusual sleep positions can cause abnormally low sleep-time SpO2 readings.
 - To turn on measurements while you are inactive during the day, select **All Day**.
NOTE: Turning on **All Day** mode decreases battery life.

Tips for Erratic Pulse Oximeter Data

If the pulse oximeter data is erratic or does not appear, you can try these tips.

- Remain motionless while the watch reads your blood oxygen saturation.
- Wear the watch above your wrist bone. The watch should be snug but comfortable.
- Hold the arm wearing the watch at heart level while the watch reads your blood oxygen saturation.
- Use a silicone or nylon band.
- Clean and dry your arm before putting on the watch.
- Avoid wearing sunscreen, lotion, and insect repellent under the watch.
- Avoid scratching the optical sensor on the back of the watch.
- Rinse the watch with fresh water after each workout.

Compass

The watch has a 3-axis compass with automatic calibration. The compass features and appearance change depending on your activity, whether GPS is enabled, and whether you are navigating to a destination. You can change the compass settings manually ([Compass Settings, page 116](#)).

Setting the Compass Heading

- 1 From the compass glance, press **START**.
- 2 Select **Lock Heading**.
- 3 Point the top of the watch toward your heading, and press **START**.
When you deviate from the heading, the compass displays the direction from the heading and degree of deviation.

Compass Settings

Hold **MENU**, and select **Sensors & Accessories > Compass**.

Calibrate: Allows you to manually calibrate the compass sensor (*Calibrating the Compass Manually*, page 116).

Display: Sets the directional heading on the compass to letters, degrees, or milliradians.

North Ref.: Sets the north reference of the compass (*Setting the North Reference*, page 116).

Mode: Sets the compass to use electronic-sensor data only (On), a combination of GPS and electronic-sensor data when moving (Auto), or GPS data only (Off).

Calibrating the Compass Manually

NOTICE

Calibrate the electronic compass outdoors. To improve heading accuracy, do not stand near objects that influence magnetic fields, such as vehicles, buildings, and overhead power lines.

Your watch was already calibrated at the factory, and the watch uses automatic calibration by default. If you experience irregular compass behavior, for example, after moving long distances or after extreme temperature changes, you can manually calibrate the compass.

- 1 Hold **MENU**.
- 2 Select **Sensors & Accessories > Compass > Calibrate**.
- 3 Select an option:
 - To perform a calibration that rotates the watch through all orientations, select **Full Calibration**.
 - To perform a short calibration that rotates the watch in a figure eight motion, select **Quick Calibration > Start**.

NOTE: The **Full Calibration** option provides better accuracy for diving. The **Quick Calibration** option is suitable for other activities.

- 4 Follow the on-screen instructions.

Setting the North Reference

You can set the directional reference used in calculating heading information.

- 1 Hold **MENU**.
- 2 Select **Sensors & Accessories > Compass > North Ref.**
- 3 Select an option:
 - To set geographic north as the heading reference, select **True**.
 - To set the magnetic declination for your location automatically, select **Magnetic**.
 - To set grid north (000°) as the heading reference, select **Grid**.
 - To set the magnetic variation value manually, select **User > Mag. Variation**, enter the magnetic variation, and select **Done**.

Altimeter and Barometer

The watch contains an internal altimeter and barometer. The watch collects elevation and pressure data continuously, even in low-power mode. The altimeter displays your approximate elevation based on pressure changes. The barometer displays environmental pressure data based on the fixed elevation where the altimeter was most recently calibrated (*Altimeter Settings*, page 117).

Altimeter Settings

Hold **MENU**, and select **Sensors & Accessories > Altimeter**.

Calibrate: Allows you to manually calibrate the altimeter sensor.

Auto Cal.: Allows the altimeter to self-calibrate each time you use satellite systems.

Sensor Mode: Sets the mode for the sensor. The Auto option uses both the altimeter and barometer according to your movement. You can use the Altimeter Only option when your activity involves changes in altitude, or the Barometer Only option when your activity does not involve changes in altitude.

Elevation: Sets the units of measure for elevation.

Calibrating the Barometric Altimeter

Your watch was already calibrated at the factory, and the watch uses automatic calibration at your GPS starting point by default. You can manually calibrate the barometric altimeter if you know the correct elevation.

- 1 Hold **MENU**.
- 2 Select **Sensors & Accessories > Altimeter**.
- 3 Select an option:
 - To calibrate automatically from your GPS starting point, select **Auto Cal.**
 - To enter the current elevation manually, select **Calibrate > Enter Manually**.
 - To enter the current elevation from the digital elevation model, select **Calibrate > Use DEM**.
 - To enter the current elevation from your GPS location, select **Calibrate > Use GPS**.

Barometer Settings

Hold **MENU**, and select **Sensors & Accessories > Barometer**.

Calibrate: Allows you to manually calibrate the barometer sensor.

Plot: Sets the time scale for the chart in the barometer glance.

Storm Alert: Sets the rate of barometric pressure change that triggers a storm alert.

Sensor Mode: Sets the mode for the sensor. The Auto option uses both the altimeter and barometer according to your movement. You can use the Altimeter Only option when your activity involves changes in altitude, or the Barometer Only option when your activity does not involve changes in altitude.

Pressure: Sets how the watch displays pressure data.

Calibrating the Barometer

Your watch was already calibrated at the factory, and the watch uses automatic calibration at your GPS starting point by default. You can manually calibrate the barometer if you know the correct elevation or the correct sea level pressure.

- 1 Hold **MENU**.
- 2 Select **Sensors & Accessories > Barometer > Calibrate**.
- 3 Select an option:
 - To enter the current elevation and sea level pressure (optional), select **Enter Manually**.
 - To calibrate automatically from the digital elevation model, select **Use DEM**.
 - To calibrate automatically from your GPS starting point, select **Use GPS**.

Wireless Sensors

Your watch can be paired and used with wireless sensors using ANT+ or Bluetooth technology (*Pairing Your Wireless Sensors*, page 120). After the devices are paired, you can customize the optional data fields (*Customizing the Data Screens*, page 60). If your watch was packaged with a sensor, they are already paired. For information about specific Garmin sensor compatibility, purchasing, or to view the owner's manual, go to buy.garmin.com for that sensor.

Sensor Type	Description
Applied Ballistics	You can use Applied Ballistics devices, such as rangefinders or wind sensors, and view additional ballistics information on your watch.
Club Sensors	You can use Approach CT10 golf club sensors to automatically track your golf shots, including location, distance, and club type.
DogTrack	Allows you to receive data from a compatible handheld dog tracking device.
eBike	You can use your watch with your eBike and view bike data, such as battery and shifting information, during your rides.
Extended Display	You can use the Extended Display mode to display data screens from your Descent watch on a compatible Edge bike computer during a ride or triathlon.
External Heart Rate	You can use an external sensor, such as the HRM-Pro or HRM-Dual™ heart rate monitor, to view heart rate data during your activities. Some heart rate monitors can also store data or provide advanced running data (Running Dynamics, page 121) (Running Power, page 122).
Foot Pod	You can use a foot pod to record pace and distance instead of using GPS when you are training indoors or when your GPS signal is weak.
Headphones	You can use Bluetooth headphones to listen to music loaded onto your Descent watch (Connecting Bluetooth Headphones, page 130).
inReach	The inReach remote function allows you to control your inReach satellite communicator using your Descent watch (Using the inReach Remote, page 123).
Lights	You can use Varia™ smart bike lights to improve situational awareness.
Muscle O2	You can use a muscle oxygen sensor to view hemoglobin and muscle oxygen saturation data while you train.
PC	You can play video games on your computer and see real-time statistics on your device (Using the Garmin GameOn™ App, page 39).
Power	You can use the Rally™ or Vector™ power meter bike pedals to view your power data on your watch. You can adjust your power zones to match your goals and abilities (Setting Your Power Zones, page 139), or use range alerts to be notified when you reach a specified power zone (Setting an Alert, page 64).
Radar	You can use a Varia rearview bike radar to improve situational awareness and send alerts about approaching vehicles. With a Varia radar camera tail light, you can also take photos and record video during a ride (Using the Varia Camera Controls, page 122).
RD Pod	You can use a Running Dynamics Pod to record running dynamics data and view it on your watch (Running Dynamics, page 121).
Shifting	You can use electronic shifters to display shifting information during a ride. The Descent watch displays current adjustment values when the sensor is in adjustment mode.
Shimano Di2	You can use Shimano® Di2™ electronic shifters to display shifting information during a ride. The Descent watch displays current adjustment values when the sensor is in adjustment mode.
Smart Trainer	You can use your watch with an indoor bike smart trainer to simulate resistance while following a course, ride, or workout (Using an Indoor Trainer, page 39).
Speed/Cadence	You can attach speed or cadence sensors to your bike and view the data during your ride. If necessary, you can manually enter your wheel circumference (Wheel Size and Circumference, page 184).

Sensor Type	Description
Tempe	You can attach the tempe temperature sensor to a secure strap or loop where it is exposed to ambient air, so it provides a consistent source of accurate temperature data.
Trolling Motor	You can use your device as a remote control for your Garmin trolling motor (Pairing Your Watch and Trolling Motor, page 47).
Vectronix	You can use Vectronix® rangefinders, and view additional ballistics information on your watch.
VIRB	The VIRB remote function allows you to control your VIRB action camera using your watch (VIRB Remote, page 123).
XERO Laser Locations	You can view and share laser location information from a Xero device (Xero Laser Location Settings, page 124).

Pairing Your Wireless Sensors

Before you can pair, you must put on the heart rate monitor or install the sensor.

The first time you connect a wireless sensor to your watch using ANT+ or Bluetooth technology, you must pair the watch and sensor. If the sensor has both ANT+ and Bluetooth technology, Garmin recommends that you pair using ANT+ technology. After they are paired, the watch connects to the sensor automatically when you start an activity and the sensor is active and within range.

NOTE: The Descent transceivers can be paired through the dive setup menu ([Pairing the Transceiver with a Descent Watch, page 9](#)).

1 Bring the watch within 3 m (10 ft.) of the sensor.

NOTE: Stay 10 m (33 ft.) away from other wireless sensors while pairing.

2 Hold **MENU**.

3 Select **Sensors & Accessories > Add New**.

TIP: When you start an activity with the Auto Discover option enabled, the watch automatically searches for nearby sensors and asks if you want to pair them.

4 Select an option:

- Select **Search All Sensors**.
- Select your sensor type.

After the sensor is paired with your watch, the sensor status changes from Searching to Connected. Sensor data appears in the data screen loop or a custom data field. You can customize the optional data fields ([Customizing the Data Screens, page 60](#)).

HRM-Pro Running Pace and Distance

The HRM-Pro series accessory calculates your running pace and distance based on your user profile and the motion measured by the sensor on every stride. The heart rate monitor provides running pace and distance when GPS is not available, such as during treadmill running. You can view your running pace and distance on your compatible Descent watch when connected using ANT+ technology. You can also view it on compatible third-party training apps when connected using Bluetooth technology.

The pace and distance accuracy improves with calibration.

Automatic calibration: The default setting for your watch is **Auto Calibrate**. The HRM-Pro series accessory calibrates each time you run outside with it connected to your compatible Descent watch.

NOTE: Automatic calibration does not work for indoor, trail, or ultra run activity profiles ([Tips for Recording Running Pace and Distance, page 121](#)).

Manual calibration: You can select **Calibrate & Save** after a treadmill run with your connected HRM-Pro series accessory ([Calibrating the Treadmill Distance, page 34](#)).

Tips for Recording Running Pace and Distance

- Update your Descent watch software ([Product Updates, page 159](#)).
- Complete several outdoor runs with GPS and your connected HRM-Pro series accessory. It's important that your outdoor range of paces matches your range of paces on the treadmill.
- If your run includes sand or deep snow, go to the sensor settings, and turn off **Auto Calibrate**.
- If you previously connected a compatible foot pod using ANT+ technology, set the foot pod status to **Off**, or remove it from the list of connected sensors.
- Complete a treadmill run with manual calibration ([Calibrating the Treadmill Distance, page 34](#)).
- If automatic and manual calibrations don't seem accurate, go to the sensor settings, and select **HRM Pace & Distance > Reset Calibration Data**.

NOTE: You can try turning off **Auto Calibrate**, and then manually calibrate again ([Calibrating the Treadmill Distance, page 34](#)).

Running Dynamics

Running dynamics is real-time feedback about your running form. Your Descent watch has an accelerometer to calculate five running form metrics. For all six running form metrics, you must pair your Descent watch with the HRM-Pro series accessory or other running dynamics accessory that measures torso movement. For more information, go to garmin.com/performance-data/running.

Metric	Sensor Type	Description
Cadence	Watch or compatible accessory	Cadence is the number of steps per minute. It displays the total steps (right and left combined).
Vertical oscillation	Watch or compatible accessory	Vertical oscillation is your bounce while running. It displays the vertical motion of your torso, measured in centimeters.
Ground contact time	Watch or compatible accessory	Ground contact time is the amount of time in each step that you spend on the ground while running. It is measured in milliseconds. NOTE: Ground contact time and balance are not available while walking.
Ground contact time balance	Compatible accessory only	Ground contact time balance displays the left/right balance of your ground contact time while running. It displays a percentage. For example, 53.2 with an arrow pointing left or right.
Stride length	Watch or compatible accessory	Stride length is the length of your stride from one footfall to the next. It is measured in meters.
Vertical ratio	Watch or compatible accessory	Vertical ratio is the ratio of vertical oscillation to stride length. It displays a percentage. A lower number typically indicates better running form.

Tips for Missing Running Dynamics Data

This topic provides tips for using a compatible running dynamics accessory. If the accessory is not connected to your watch, the watch automatically switches to wrist-based running dynamics.

- Make sure you have a running dynamics accessory, such as the HRM-Pro series accessory. Accessories with running dynamics have  on the front of the module.
- Pair the running dynamics accessory with your watch again, according to the instructions.
- If you are using the HRM-Pro series accessory, pair it with your watch using ANT+ technology, rather than Bluetooth technology.
- If the running dynamics data display shows only zeros, make sure the accessory is worn right-side up.
NOTE: Ground contact time and balance appears only while running. It is not calculated while walking.
REMEMBER: Ground contact time balance is not calculated with wrist-based running dynamics.

Running Power

Garmin running power is calculated using measured running dynamics information, user mass, environmental data, and other sensor data. The power measurement estimates the amount of power a runner applies to the road surface, and it is displayed in watts. Using running power as a gauge of effort may suit some runners better than using either pace or heart rate. Running power can be more responsive than heart rate for indicating the level of effort, and it can account for the uphill, downhill, and wind, which a pace measurement does not do. For more information, go to garmin.com/performance-data/running.

Running power can be measured using a compatible running dynamics accessory or the watch sensors. You can customize the running power data fields to view your power output and make adjustments to your training ([Data Fields, page 164](#)). You can set up power alerts to be notified when you reach a specified power zone ([Activity Alerts, page 63](#)).

Running power zones are similar to cycling power zones. The values for the zones are default values based on gender, weight, and average ability, and may not match your personal abilities. You can manually adjust your zones on the watch or using your Garmin Connect account ([Setting Your Power Zones, page 139](#)).

Running Power Settings

Hold **MENU**, select **Activities & Apps**, select a running activity, select the activity settings, and select **Running Power**.

Status: Enables or disables recording Garmin running power data. You can use this setting if you prefer to use third-party running power data.

Source: Allows you to select which device to use to record running power data. The Smart Mode option automatically detects and uses the running dynamics accessory, when available. The watch uses wrist-based running power data when an accessory is not connected.



Account for Wind: Enables or disables using wind data when calculating your running power. Wind data is a combination of the speed, heading, and barometer data from your watch and the available wind data from your phone.

Using the Varia Camera Controls

NOTICE

Some jurisdictions may prohibit or regulate the recording of video, audio, or photographs, or may require that all parties have knowledge of the recording and provide consent. It is your responsibility to know and follow all laws, regulations, and any other restrictions in jurisdictions where you plan to use this device.

Before you can use the Varia camera controls, you must pair the accessory with your watch ([Pairing Your Wireless Sensors, page 120](#)).

- 1 Add the **RCT Camera** glance to your watch ([Glances, page 86](#)).
- 2 From the **RCT Camera** glance, select an option:
 - Select  to view the camera settings.
 - Select  to take a photo.
 - Select  to save a clip.

inReach Remote

The inReach remote function allows you to control your inReach satellite communicator using your Descent watch. Go to buy.garmin.com for more information about compatible devices.

Using the inReach Remote

Before you can use the inReach remote function, you must add the inReach glance to the glance loop ([Customizing the Glance Loop, page 90](#)).

- 1 Turn on the inReach satellite communicator.
- 2 On your Descent watch, press **UP** or **DOWN** from the watch face to view the inReach glance.
- 3 Press **START** to search for your inReach satellite communicator.
- 4 Press **START** to pair your inReach satellite communicator.
- 5 Press **START**, and select an option:
 - To send an SOS message, select **Initiate SOS**.
NOTE: You should only use the SOS function in a real emergency situation.
 - To send a text message, select **Messages > New Message**, select the message contacts, and enter the message text or select a quick text option.
 - To send a preset message, select **Send Preset**, and select a message from the list.
 - To view the timer and distance traveled during an activity, select **Tracking**.

VIRB Remote

The VIRB remote function allows you to control your VIRB action camera using your device.

Controlling a VIRB Action Camera

Before you can use the VIRB remote function, you must enable the remote setting on your VIRB camera. See the *VIRB Series Owner's Manual* for more information.

- 1 Turn on your VIRB camera.
- 2 Pair your VIRB camera with your Descent watch ([Pairing Your Wireless Sensors, page 120](#)).
The VIRB glance is automatically added to the glance loop.
- 3 Press **UP** or **DOWN** from the watch face to view the VIRB glance.
- 4 If necessary, wait while your watch connects to your camera.
- 5 Select an option:
 - To record video, select **Start Recording**.
The video counter appears on the Descent screen.
 - To take a photo while recording video, press **DOWN**.
 - To stop recording video, press **STOP**.
 - To take a photo, select **Take Photo**.
 - To take multiple photos in burst mode, select **Take Burst**.
 - To send the camera to sleep mode, select **Sleep Camera**.
 - To wake the camera from sleep mode, select **Wake Camera**.
 - To change video and photo settings, select **Settings**.

Controlling a VIRB Action Camera During an Activity

Before you can use the VIRB remote function, you must enable the remote setting on your VIRB camera. See the *VIRB Series Owner's Manual* for more information.

- 1 Turn on your VIRB camera.
- 2 Pair your VIRB camera with your Descent watch (*Pairing Your Wireless Sensors, page 120*).
When the camera is paired, a VIRB data screen is automatically added to activities.
NOTE: The VIRB data screen is not available for dive activities.
- 3 During an activity, press **UP** or **DOWN** to view the VIRB data screen.
- 4 If necessary, wait while your watch connects to your camera.
- 5 Hold **MENU**.
- 6 Select **VIRB**.
- 7 Select an option:
 - To control the camera using the activity timer, select **Settings > Recording Mode > Timer Start/Stop**.
NOTE: Video recording automatically starts and stops when you start and stop an activity.
 - To control the camera using the menu options, select **Settings > Recording Mode > Manual**.
 - To manually record video, select **Start Recording**.
The video counter appears on the Descent screen.
 - To take a photo while recording video, press **DOWN**.
 - To manually stop recording video, press **STOP**.
 - To take multiple photos in burst mode, select **Take Burst**.
 - To send the camera to sleep mode, select **Sleep Camera**.
 - To wake the camera from sleep mode, select **Wake Camera**.

Xero Laser Location Settings

Before you can customize laser location settings, you must pair a compatible Xero device (*Pairing Your Wireless Sensors, page 120*).

Hold **MENU**, and select **Sensors & Accessories > XERO Laser Locations > Laser Locations**.

During Activity: Enables the display of laser location information from a compatible, paired Xero device during an activity.

Share Mode: Allows you to share laser location information publicly or broadcast it privately.

Map

Your watch can display several types of Garmin map data, including topographical contours, nearby points of interest, ski resort maps, and golf courses. You can use the Map Manager to download additional maps or manage map storage.

To purchase additional map data and view compatibility information, go to garmin.com/maps.

▲ represents your location on the map. When you are navigating to a destination, your route is marked with a line on the map.

Viewing the Map

- 1 Select an option to open the map:
 - Press **START**, and select **Map** to view the map without starting an activity.
 - Go outside, start a GPS activity (*Starting an Activity, page 32*), and press **UP** or **DOWN** to scroll to the map screen.
- 2 If necessary, wait while the watch locates satellites.
- 3 Select an option to pan and zoom the map:
 - To use the touchscreen, tap the map, tap and drag to position the crosshairs, and press **UP** or **DOWN** to zoom in or out.
 - To use the buttons, hold **MENU**, select **Pan/Zoom**, and press **UP** or **DOWN** to zoom in or out.
NOTE: You can press **START** to toggle between panning up and down, panning left and right, or zooming.
- 4 Hold **START** to select the point indicated by the crosshairs.

Saving or Navigating to a Location on the Map

You can select any location on the map. You can save the location or start navigating to it.

- 1 From the map, select an option:
 - To use the touchscreen, tap the map, tap and drag to position the crosshairs, and press **UP** or **DOWN** to zoom in or out.
 - To use the buttons, hold **MENU**, select **Pan/Zoom**, and press **UP** or **DOWN** to zoom in or out.
NOTE: You can press **START** to toggle between panning up and down, panning left and right, or zooming.

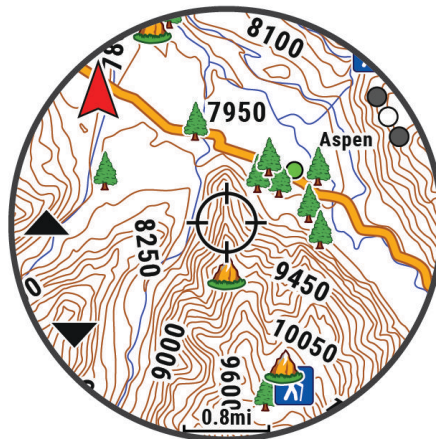

- 2 Pan and zoom the map to center the location in the crosshairs.
- 3 Hold **START** to select the point indicated by the crosshairs.
- 4 If necessary, select a nearby point of interest.
- 5 Select an option:
 - To start navigating to the location, select **Go**.
 - To save the location, select **Save Location**.
 - To view information about the location, select **Review**.

Navigating with the Around Me Feature

You can use the around me feature to navigate to nearby points of interest and waypoints.

NOTE: The map data installed on your watch must include points of interest to navigate to them.

- 1 From the map, hold **MENU**.
- 2 Select **Around Me**.
Icons indicating points of interest and waypoints appear on the map.
- 3 Press **UP** or **DOWN** to highlight a section of the map.
- 4 Press **START**.
A list of points of interest and waypoints in the highlighted map section appear.
- 5 Select a location.
- 6 Select an option:
 - To start navigating to the location, select **Go**.
 - To view the location on the map, select **Map**.
 - To save the location, select **Save Location**.
 - To view information about the location, select **Review**.

Map Settings

You can customize how the map appears in the map app and data screens.

NOTE: If necessary, you can customize the map settings for specific activities instead of using the system settings ([Activity Map Settings, page 64](#)).

Hold **MENU**, and select **Map**.

Map Manager: Shows the downloaded map versions and allows you to download additional maps ([Managing Maps, page 127](#)).

Map Theme: Sets the map to display data optimized for your activity type ([Map Themes, page 128](#)).

Color Mode: Sets the map colors to either a white or black background for daytime or nighttime visibility. The Auto option adjusts the map colors based on the time of day.

Orientation: Sets the orientation of the map. The North Up option shows north at the top of the screen. The Track Up option shows your current direction of travel at the top of the screen.

User Locations: Shows or hides saved locations on the map.

Segments: Shows or hides segments, as a colored line on the map.

Contours: Shows or hides contour lines on the map.

Track Log: Shows or hides the track log, or the path you have traveled, as a colored line on the map.

Track Color: Changes the track log color.

Auto Zoom: Automatically selects the zoom level for optimal use of your map. When disabled, you must zoom in or out manually.

Lock on Road: Locks the position icon, which represents your position on the map, onto the nearest road.

Detail: Sets the amount of detail shown on the map. Showing more detail may cause the map to redraw more slowly.

Shaded Relief: Shows or hides relief shading for a three dimensional view of the map topography.

Marine: Sets the map to display data in marine mode ([Marine Map Settings, page 128](#)).

Restore Theme: Allows you to restore default map theme settings or themes that have been deleted from the watch.

Managing Maps

- 1 Hold **MENU**.
- 2 Select **Map > Map Manager**.
- 3 Select an option:
 - To download premium maps and activate your Outdoor Maps+ subscription for this device, select **Outdoor Maps+** ([Downloading Maps with Outdoor Maps+](#), page 127).
 - To download TopoActive maps, select **TopoActive Maps** ([Downloading TopoActive Maps](#), page 127).

Downloading Maps with Outdoor Maps+

Before you can download maps to your device, you must connect to a wireless network ([Connecting to a Wi-Fi Network](#), page 134).

- 1 Hold **MENU**.
- 2 Select **Map > Map Manager > Outdoor Maps+**.
- 3 If necessary, press **START**, and select **Check Subscription** to activate your Outdoor Maps+ subscription for this watch.

NOTE: Go to garmin.com/outdoormaps for information about purchasing a subscription.

- 4 Select **Add Map**, and select a location.
A preview of the map region appears.
- 5 From the map, complete one or more actions:
 - Drag the map to view different areas.
 - Pinch or spread two fingers on the touchscreen to zoom in and out of the map.
 - Select **+** and **-** to zoom in and out of the map.
- 6 Press **BACK**, and select **✓**.
- 7 Select **✎**.
- 8 Select an option:
 - To edit the map name, select **Name**.
 - To change the map layers to download, select **Layers**.
TIP: You can select **i** to view details about the map layers.
 - To modify the map region, select **Selected Area**.
- 9 Select **✓** to download the map.
NOTE: To prevent battery drain, the watch queues the map download for later, and the download starts when you connect the watch to an external power source.

Downloading TopoActive Maps

Before you can download maps to your device, you must connect to a wireless network ([Connecting to a Wi-Fi Network](#), page 134).

- 1 Hold **MENU**.
- 2 Select **Map > Map Manager > TopoActive Maps > Add Map**.
- 3 Select a map.
- 4 Press **START**, and select **Download**.
NOTE: To prevent battery drain, the watch queues the map download for later, and the download starts when you connect the watch to an external power source.

Deleting Maps

You can remove maps to increase the available device storage.

- 1 Hold **MENU**.
- 2 Select **Map > Map Manager**.
- 3 Select an option:
 - Select **TopoActive Maps**, select a map, press **START**, and select **Remove**.
 - Select **Outdoor Maps+**, select a map, press **START**, and select **Delete**.

Map Themes

You can change the map theme to display data optimized for your activity type.

Hold **MENU**, and select **Map > Map Theme**.

None: Uses the preferences from the system map settings, with no additional theme applied.

Marine: Sets the map to display data in marine mode.

High Contrast: Sets the map to display data with higher contrast, for better visibility in challenging environments.

Dark: Sets the map to display data with a dark background, for better visibility at night.

Popularity: Highlights the most popular roads or trails on the map.

Resort Ski: Sets the map to display the most relevant ski data at a glance.

Aviation: Sets the map to display data in aviation mode.

Marine Map Settings

You can customize how the map appears in marine mode.

Hold **MENU**, and select **Map > Marine**.

Spot Soundings: Enables depth measurements on the chart.

Light Sectors: Shows and configures the appearance of light sectors on the chart.

Symbol Set: Sets the chart symbols in marine mode. The NOAA option displays the National Oceanic and Atmospheric Administration chart symbols. The International option displays the International Association of Lighthouse Authorities chart symbols.

Showing and Hiding Map Data

If you have multiple maps installed on your device, you can choose the map data to show on the map.

- 1 From the watch face, press **START**.
- 2 Select **Map**.
- 3 Hold **MENU**.
- 4 Select the map settings.
- 5 Select **Map > Configure Maps**.
- 6 Select a map to activate the toggle switch, which shows or hides the map data.

Music

NOTE: There are three different music playback options for your Descent watch.

- Third-party provider music
- Personal audio content
- Music stored on your phone

On a Descent watch, you can download audio content to your watch from your computer or from a third-party provider, so you can listen when your phone is not nearby. To listen to audio content stored on your watch, you can connect Bluetooth headphones.

Connecting to a Third-Party Provider

Before you can download music or other audio files to your watch from a supported third-party provider, you must connect the provider to your watch.

Some third-party music provider options are already installed on your watch.

For more options, you can download the Connect IQ app on your phone ([Downloading Connect IQ Features](#), page 136).

- 1 From the watch face, press **START**.
- 2 Select **Connect IQ Store**.
- 3 Follow the on-screen instructions to install a third-party music provider.
- 4 Hold **DOWN** from any screen to open the music controls.
- 5 Select the music provider.

NOTE: If you want to select another provider, hold **MENU**, select **Music Providers**, and follow the on-screen instructions.

Downloading Audio Content from a Third-Party Provider

Before you can download audio content from a third-party provider, you must connect to a Wi-Fi network ([Connecting to a Wi-Fi Network](#), page 134).

- 1 Hold **DOWN** from any screen to open the music controls.
- 2 Hold **MENU**.
- 3 Select **Music Providers**.
- 4 Select a connected provider, or select **Add Provider** to add a music provider from the Connect IQ store.
- 5 Select a playlist or other item to download to the watch.
- 6 If necessary, press **BACK** until you are prompted to sync with the service.

NOTE: Downloading audio content can drain the battery. You may be required to connect the watch to an external power source if the battery is low.

Downloading Personal Audio Content

Before you can send your personal music to your watch, you must install the Garmin Express application on your computer (garmin.com/express).

You can load your personal audio files, such as .mp3 and .m4a files, to a Descent watch from your computer. For more information, go to garmin.com/musicfiles.









- 1 Connect the watch to your computer using the included USB cable.
- 2 On your computer, open the Garmin Express application, select your watch, and select **Music**.
TIP: For Windows® computers, you can select  and browse to the folder with your audio files. For Apple® computers, the Garmin Express application uses your iTunes® library.
- 3 In the **My Music** or **iTunes Library** list, select an audio file category, such as songs or playlists.
- 4 Select the checkboxes for the audio files, and select **Send to Device**.
- 5 If necessary, in the Descent list, select a category, select the checkboxes, and select **Remove From Device** to remove audio files.

Listening to Music

- 1 Hold **DOWN** from any screen to open the music controls.
- 2 If necessary, connect your Bluetooth headphones ([Connecting Bluetooth Headphones, page 130](#)).
- 3 Hold **MENU**.
- 4 Select **Music Providers**, and select an option:
 - To listen to music downloaded to the watch from your computer, select **My Music** ([Downloading Personal Audio Content, page 129](#)).
 - To control music playback on your phone, select **Control Phone**.
 - To listen to music from a third-party provider, select the name of the provider, and select a playlist.
- 5 Select .

Music Playback Controls

NOTE: Music playback controls may look different, depending on the selected music source.

	Select to view more music playback controls.
	Select to browse the audio files and playlists for the selected source.
	Select to adjust the volume.
	Select to play and pause the current audio file.
	Select to skip to the next audio file in the playlist. Hold to fast forward through the current audio file.
	Select to restart the current audio file. Select twice to skip to the previous audio file in the playlist. Hold to rewind through the current audio file.
	Select to change the repeat mode.
	Select to change the shuffle mode.

Connecting Bluetooth Headphones

To listen to music loaded onto your Descent watch, you must connect Bluetooth headphones.

- 1 Bring the headphones within 2 m (6.6 ft.) of your watch.
- 2 Enable pairing mode on the headphones.
- 3 Hold **MENU**.
- 4 Select **Music > Headphones > Add New**.
- 5 Select your headphones to complete the pairing process.

Changing the Audio Mode

You can change the music playback mode from stereo to mono.

- 1 Hold **MENU**.
- 2 Select **Music > Audio**.
- 3 Select an option.

Connectivity

Connectivity features are available for your watch when you pair with your compatible phone ([Pairing Your Phone, page 131](#)). Additional features are available when you connect your watch to a Wi-Fi network ([Connecting to a Wi-Fi Network, page 134](#)).

Phone Connectivity Features

Phone connectivity features are available for your Descent watch when you pair it using the Garmin Dive app ([Pairing Your Phone, page 131](#)).

- App features from the Garmin Dive app ([Garmin Dive App, page 136](#))
- App features from the Garmin Connect app, the Connect IQ app, and more ([Phone Apps and Computer Applications, page 134](#))
- Glances ([Glances, page 86](#))
- Controls menu features ([Controls, page 106](#))
- Safety and tracking features ([Safety and Tracking Features, page 140](#))
- Phone interactions, such as notifications ([Enabling Bluetooth Notifications, page 131](#))

Pairing Your Phone

To use the connected features on your watch, you must pair it directly through the Garmin Dive app, instead of from the Bluetooth settings on your phone.

- 1 During the initial setup on your watch, select  when you are prompted to pair with your phone.
NOTE: If you previously skipped the pairing process, you can hold **MENU**, and select **Connectivity > Phone > Pair Phone**.
- 2 Scan the QR code with your phone, and follow the on-screen instructions to complete the pairing and setup process.

Enabling Bluetooth Notifications

Before you can enable notifications, you must pair the watch with a compatible phone ([Pairing Your Phone, page 131](#)).



- 1 Hold **MENU**.
- 2 Select **Connectivity > Phone > Smart Notifications > Status > On**.
- 3 Select **During Activity** or **General Use**.
- 4 Select a notification type.
- 5 Select status, tone, and vibration preferences.
- 6 Press **BACK**.
- 7 Select privacy and timeout preferences.
- 8 Press **BACK**.
- 9 Select **Signature** to add a signature to your text message replies.

Viewing Notifications

- 1 From the watch face, press **UP** or **DOWN** to view the notifications glance.
- 2 Press **START**.
- 3 Select a notification.
- 4 Press **START** for more options.
- 5 Press **BACK** to return to the previous screen.

Receiving an Incoming Phone Call

When you receive a phone call on your connected phone, the Descent watch displays the name or phone number of the caller.

- To accept the call, select .
NOTE: To talk to the caller, you must use your connected phone.
- To decline the call, select .
- To decline the call and immediately send a text message reply, select **Reply**, and select a message from the list.
NOTE: To send a text message reply, you must be connected to a compatible Android™ phone using Bluetooth technology.

Replying to a Text Message

NOTE: This feature is available only for compatible Android phones.

When you receive a text message notification on your watch, you can send a quick reply by selecting from a list of messages. You can customize messages in the Garmin Connect app.

NOTE: This feature sends text messages using your phone. Regular text message limits and charges from your carrier and phone plan may apply. Contact your mobile carrier for more information about text message charges or limits.

- 1 From the watch face, press **UP** or **DOWN** to view the notifications glance.
- 2 Press **START**, and select a text message notification.
- 3 Press **START**.
- 4 Select **Reply**.
- 5 Select a message from the list.

Your phone sends the selected message as an SMS text message.

Managing Notifications

You can use your compatible phone to manage notifications that appear on your Descent watch.

Select an option:

- If you are using an iPhone®, go to the iOS® notifications settings to select the items to show on the watch.
- If you are using an Android phone, from the Garmin Connect app, select **••• > Settings > Notifications**.

Turning Off the Bluetooth Phone Connection

You can turn off the Bluetooth phone connection from the controls menu.

NOTE: You can add options to the controls menu (*Customizing the Controls Menu*, page 109).

- 1 Hold **LIGHT** to view the controls menu.
- 2 Select  to turn off the Bluetooth phone connection on your Descent watch.

Refer to the owner's manual for your phone to turn off Bluetooth technology on your phone.

Turning On and Off Phone Connection Alerts

You can set the Descent watch to alert you when your paired phone connects and disconnects using Bluetooth technology.

NOTE: Phone connection alerts are turned off by default.

- 1 Hold **MENU**.
- 2 Select **Connectivity > Phone > Alerts**.

Turning On and Off Find My Phone Alerts

- 1 Hold **MENU**.
- 2 Select **Notifications & Alerts > System Alerts > Find My Phone Alerts**.

Locating a Phone Lost During a GPS Activity

Your Descent watch automatically stores a GPS location when your paired phone is disconnected during a GPS activity. You can use this feature to help locate a phone that is lost during an activity.

- 1 Start a GPS activity.
- 2 When prompted to navigate to the last known location of your device, select .
- 3 Navigate to the location on the map ([Saving or Navigating to a Location on the Map](#), page 125).
- 4 Press **DOWN** to view a compass pointing to the location (optional).
- 5 When your watch is within Bluetooth range of your phone, the Bluetooth signal strength appears on the screen.

The signal strength increases as you move closer to your phone.

Playing Audio Prompts During an Activity

You can enable your Descent watch to play motivational status announcements during a run or other activity. Audio prompts play on your connected Bluetooth headphones, if available. Otherwise, audio prompts play on your phone paired through the Garmin Connect app. During an audio prompt, the watch or phone mutes the primary audio to play the announcement.

NOTE: This feature is not available for all activities.

- 1 Hold **MENU**.
- 2 Select **Audio Prompts**.
- 3 Select an option:
 - To hear a prompt for each lap, select **Lap Alert**.
 - To customize prompts with your pace and speed information, select **Pace/Speed Alert**.
 - To customize prompts with your heart rate information, select **Heart Rate Alert**.
 - To customize prompts with power data, select **Power Alert**.
 - To hear prompts when you start and stop the activity timer, including the Auto Pause feature, select **Timer Events**.
 - To hear workout alerts play as an audio prompt, select **Workout Alerts**.
 - To hear activity alerts play as an audio prompt, select **Activity Alerts** ([Activity Alerts](#), page 63).
 - To hear a sound play right before an audio alert or prompt, select **Audio Tones**.
 - To change the language or the dialect of the voice prompts, select **Dialect**.

Wi-Fi Connectivity Features

Activity uploads to your Garmin Connect account: Automatically sends your activity to your Garmin Connect account as soon as you finish recording the activity.

Audio content: Allows you to sync audio content from third-party providers.

Course updates: Allows you to download and install golf course updates.

Map downloads: Allows you to download and install maps.

Software updates: You can download and install the latest software.

Workouts and training plans: You can browse for and select workouts and training plans on the Garmin Connect site. The next time your watch has a Wi-Fi connection, the files are sent to your watch.

Connecting to a Wi-Fi Network

You must connect your watch to the Garmin Connect app on your phone or to the Garmin Express application on your computer before you can connect to a Wi-Fi network.

- 1 Hold **MENU**.
- 2 Select **Connectivity > Wi-Fi > My Networks > Add Network**.
The watch displays a list of nearby Wi-Fi networks.
- 3 Select a network.
- 4 If necessary, enter the password for the network.

The watch connects to the network, and the network is added to the list of saved networks. The watch reconnects to this network automatically when it is within range.

Phone Apps and Computer Applications

You can connect your watch to multiple Garmin phone apps and computer applications using the same Garmin account.

Garmin Connect

You can connect with your friends on Garmin Connect. Garmin Connect gives you the tools to track, analyze, share, and encourage each other. Record the events of your active lifestyle including runs, walks, rides, swims, hikes, triathlons, and more. To sign up for a free account, you can download the app from the app store on your phone (garmin.com/connectapp), or go to connect.garmin.com.

Store your activities: After you complete and save an activity with your watch, you can upload that activity to your Garmin Connect account and keep it as long as you want.

Analyze your data: You can view more detailed information about your activity, including time, distance, elevation, heart rate, calories burned, cadence, running dynamics, an overhead map view, pace and speed charts, and customizable reports.

NOTE: Some data requires an optional accessory such as a heart rate monitor.



Plan your training: You can choose a fitness goal and load one of the day-by-day training plans.

Track your progress: You can track your daily steps, join a friendly competition with your connections, and meet your goals.

Share your activities: You can connect with friends to follow each other's activities or share links to your activities.

Manage your settings: You can customize your watch and user settings on your Garmin Connect account.

Using the Garmin Connect App

After you pair your watch with your phone ([Pairing Your Phone, page 131](#)), you can use the Garmin Connect app to upload all of your activity data to your Garmin Connect account.

- 1 Verify the Garmin Connect app is running on your phone.
- 2 Bring your watch within 10 m (30 ft.) of your phone.

Your watch automatically syncs your data with the Garmin Connect app and your Garmin Connect account.

Updating the Software Using the Garmin Connect App

Before you can update your watch software using the Garmin Connect app, you must have a Garmin Connect account, and you must pair the watch with a compatible phone ([Pairing Your Phone, page 131](#)).

Sync your watch with the Garmin Connect app ([Using the Garmin Connect App, page 135](#)).

When new software is available, the Garmin Connect app automatically sends the update to your watch.

Using Garmin Connect on Your Computer

The Garmin Express application connects your watch to your Garmin Connect account using a computer. You can use the Garmin Express application to upload your activity data to your Garmin Connect account and to send data, such as workouts or training plans, from the Garmin Connect website to your watch. You can also add music to your watch ([Downloading Personal Audio Content, page 129](#)). You can also install software updates and manage your Connect IQ apps.

- 1 Connect the watch to your computer using the USB cable.
- 2 Go to garmin.com/express.
- 3 Download and install the Garmin Express application.
- 4 Open the Garmin Express application, and select **Add Device**.
- 5 Follow the on-screen instructions.

Updating the Software Using Garmin Express

Before you can update your device software, you must have a Garmin Connect account, and you must download the Garmin Express application.

- 1 Connect the device to your computer using the USB cable.
When new software is available, Garmin Express sends it to your device.
- 2 Follow the on-screen instructions.
- 3 Do not disconnect your device from the computer during the update process.

NOTE: If you have already set up your device with Wi-Fi connectivity, Garmin Connect can automatically download available software updates to your device when it connects using Wi-Fi.

Manually Syncing Data with Garmin Connect

NOTE: You can add options to the controls menu ([Customizing the Controls Menu, page 109](#)).

- 1 Hold **LIGHT** to view the controls menu.
- 2 Select **Sync**.

Connect IQ Features

You can add Connect IQ apps, data fields, glances, music providers, and watch faces to your watch using the Connect IQ store on your watch or phone (garmin.com/connectiqapp).

NOTE: For your safety, Connect IQ features are not available while diving. This ensures that all dive capabilities function as designed.

Watch Faces: Customize the appearance of the clock.

Device Apps: Add interactive features to your watch, such as glances and new outdoor and fitness activity types.

Data Fields: Download new data fields that present sensor, activity, and history data in new ways. You can add Connect IQ data fields to built-in features and pages.

Music: Add music providers to your watch.

Downloading Connect IQ Features

Before you can download features from the Connect IQ app, you must pair your Descent watch with your phone ([Pairing Your Phone](#), page 131).

- 1 From the app store on your phone, install and open the Connect IQ app.
- 2 If necessary, select your watch.
- 3 Select a Connect IQ feature.
- 4 Follow the on-screen instructions.

Downloading Connect IQ Features Using Your Computer

- 1 Connect the watch to your computer using a USB cable.
- 2 Go to apps.garmin.com, and sign in.
- 3 Select a Connect IQ feature, and download it.
- 4 Follow the on-screen instructions.

Garmin Dive App

The Garmin Dive app allows you to upload your dive logs from your compatible Garmin device. You can add more detailed information about your dives, including environmental conditions, photos, notes, and dive buddies. You can use the map to browse for new dive locations, and view the location details and photos shared by other users.

The Garmin Dive app syncs your data with your Garmin Connect account. You can download the Garmin Dive app from the app store on your phone (garmin.com/diveapp).

Garmin Explore™

The Garmin Explore website and app allow you to create courses, waypoints, and collections, plan trips, and use cloud storage. They offer advanced planning both online and offline, allowing you to share and sync data with your compatible Garmin device. You can use the app to download maps for offline access, and then navigate anywhere without using your cellular service.

You can download the Garmin Explore app from the app store on your phone (garmin.com/exploreapp), or you can go to explore.garmin.com.

Garmin Golf App

The Garmin Golf app allows you to upload scorecards from your Descent device to view detailed statistics and shot analyses. Golfers can compete with each other at different courses using the Garmin Golf app. More than 43,000 courses have leaderboards that anyone can join. You can set up a tournament event and invite players to compete. With a Garmin Golf membership, you can view green contour data on your phone and Descent device.

The Garmin Golf app syncs your data with your Garmin Connect account. You can download the Garmin Golf app from the app store on your phone (garmin.com/golfapp).

User Profile

You can update your user profile on your watch or on the Garmin Connect app.

Setting Up Your User Profile

You can update your sex, date of birth, height, weight, wrist, heart rate zone, power zone, and Critical Swim Speed (CSS) settings. The watch uses this information to calculate accurate training data.

- 1 Hold **MENU**.
- 2 Select **User Profile**.
- 3 Select an option.

Gender Settings

When you first set up the watch, you must choose a sex. Most fitness and training algorithms are binary. For the most accurate results, Garmin recommends selecting your sex assigned at birth. After the initial setup, you can customize the profile settings in your Garmin Connect account.

Profile & Privacy: Enables you to customize the data on your public profile.

User Settings: Sets your sex. If you select Not Specified, the algorithms that require a binary input will use the sex you specified when you first set up the watch.

Viewing Your Fitness Age

Your fitness age gives you an idea of how your fitness compares with a person of the same sex. Your watch uses information, such as your age, body mass index (BMI), resting heart rate data, and vigorous activity history to provide a fitness age. If you have a Garmin Index™ scale, your watch uses the body fat percentage metric instead of BMI to determine your fitness age. Exercise and lifestyle changes can impact your fitness age.

NOTE: For the most accurate fitness age, complete the user profile setup ([Setting Up Your User Profile, page 136](#)).

- 1 Hold **MENU**.
- 2 Select **User Profile > Fitness Age**.

About Heart Rate Zones

Many athletes use heart rate zones to measure and increase their cardiovascular strength and improve their level of fitness. A heart rate zone is a set range of heartbeats per minute. The five commonly accepted heart rate zones are numbered from 1 to 5 according to increasing intensity. Generally, heart rate zones are calculated based on percentages of your maximum heart rate.

Fitness Goals

Knowing your heart rate zones can help you measure and improve your fitness by understanding and applying these principles.

- Your heart rate is a good measure of exercise intensity.
- Training in certain heart rate zones can help you improve cardiovascular capacity and strength.

If you know your maximum heart rate, you can use the table ([Heart Rate Zone Calculations, page 139](#)) to determine the best heart rate zone for your fitness objectives.

If you do not know your maximum heart rate, use one of the calculators available on the Internet. Some gyms and health centers can provide a test that measures maximum heart rate. The default maximum heart rate is 220 minus your age.

Setting Your Heart Rate Zones

The watch uses your user profile information from the initial setup to determine your default heart rate zones. You can set separate heart rate zones for sport profiles, such as running, cycling, and swimming. For the most accurate calorie data during your activity, set your maximum heart rate. You can also set each heart rate zone and enter your resting heart rate manually. You can manually adjust your zones on the watch or using your Garmin Connect account.

- 1 Hold **MENU**.
- 2 Select **User Profile > Heart Rate & Power Zones > Heart Rate**.
- 3 Select **Max. HR**, and enter your maximum heart rate.
You can use the Auto Detection feature to automatically record your maximum heart rate during an activity ([Detecting Performance Measurements Automatically, page 139](#)).
- 4 Select **LTHR**, and enter your lactate threshold heart rate.
You can perform a guided test to estimate your lactate threshold ([Lactate Threshold, page 97](#)). You can use the Auto Detection feature to automatically record your lactate threshold during an activity ([Detecting Performance Measurements Automatically, page 139](#)).
- 5 Select **Resting HR > Set Custom**, and enter your resting heart rate.
You can use the average resting heart rate measured by your watch, or you can set a custom resting heart rate.
- 6 Select **Zones > Based On**.
- 7 Select an option:
 - Select **%Max. HR** to view and edit the zones as a percentage of your maximum heart rate.
 - Select **%HRR** to view and edit the zones as a percentage of your heart rate reserve (maximum heart rate minus resting heart rate).
 - Select **%LTHR** to view and edit the zones as a percentage of your lactate threshold heart rate.
- 8 Select a zone, and enter a value for each zone.
- 9 Select **Sport Heart Rate**, and select a sport profile to add separate heart rate zones (optional).
- 10 Repeat the steps to add sport heart rate zones (optional).

Letting the Watch Set Your Heart Rate Zones

The default settings allow the watch to detect your maximum heart rate and set your heart rate zones as a percentage of your maximum heart rate.

- Verify that your user profile settings are accurate ([Setting Up Your User Profile, page 136](#)).
- Run often with the wrist or chest heart rate monitor.
- Try a few heart rate training plans, available from your Garmin Connect account.
- View your heart rate trends and time in zones using your Garmin Connect account.

Heart Rate Zone Calculations

Zone	% of Maximum Heart Rate	Perceived Exertion	Benefits
1	50–60%	Relaxed, easy pace, rhythmic breathing	Beginning-level aerobic training, reduces stress
2	60–70%	Comfortable pace, slightly deeper breathing, conversation possible	Basic cardiovascular training, good recovery pace
3	70–80%	Moderate pace, more difficult to hold conversation	Improved aerobic capacity, optimal cardiovascular training
4	80–90%	Fast pace and a bit uncomfortable, breathing forceful	Improved anaerobic capacity and threshold, improved speed
5	90–100%	Sprinting pace, unsustainable for long period of time, labored breathing	Anaerobic and muscular endurance, increased power

Setting Your Power Zones

The power zones use default values based on gender, weight, and average ability, and may not match your personal abilities. If you know your functional threshold power (FTP) or threshold power (TP) value, you can enter it and allow the software to calculate your power zones automatically. You can manually adjust your zones on the watch or using your Garmin Connect account.

- 1 Hold **MENU**.
- 2 Select **User Profile > Heart Rate & Power Zones > Power**.
- 3 Select an activity.
- 4 Select **Based On**.
- 5 Select an option:
 - Select **Watts** to view and edit the zones in watts.
 - Select **% FTP** or **% TP** to view and edit the zones as a percentage of your threshold power.
- 6 Select **FTP** or **Threshold Power**, and enter your value.

You can use the Auto Detection feature to automatically record your threshold power during an activity ([Detecting Performance Measurements Automatically, page 139](#)).
- 7 Select a zone, and enter a value for each zone.
- 8 If necessary, select **Minimum**, and enter a minimum power value.

Detecting Performance Measurements Automatically

The Auto Detection feature is turned on by default. The watch can automatically detect your maximum heart rate and lactate threshold during an activity. When paired with a compatible power meter, the watch can automatically detect your functional threshold power (FTP) during an activity.

- 1 Hold **MENU**.
- 2 Select **User Profile > Heart Rate & Power Zones > Auto Detection**.
- 3 Select an option.

Safety and Tracking Features

⚠ CAUTION

The safety and tracking features are supplemental features and should not be relied on as a primary method to obtain emergency assistance. The Garmin Connect app does not contact emergency services on your behalf.

NOTICE

To use the safety and tracking features, the Descent watch must be connected to the Garmin Connect app using Bluetooth technology. Your paired phone must be equipped with a data plan and be in an area of network coverage where data is available. You can enter emergency contacts in your Garmin Connect account.

For more information about safety and tracking features, go to garmin.com/safety.

Assistance: Allows you to send a message with your name, LiveTrack link, and GPS location (if available) to your emergency contacts.

Incident detection: When the Descent watch detects an incident during certain outdoor activities, the watch sends an automated message, LiveTrack link, and GPS location (if available) to your emergency contacts.

LiveTrack: Allows friends and family to follow your races and training activities in real time. You can invite followers using email or social media, allowing them to view your live data on a web page.

Live Event Sharing: Allows you to send messages to friends and family during an event, providing real-time updates.

NOTE: This feature is available only if your watch is connected to a compatible Android phone.

GroupTrack: Allows you to keep track of your connections using LiveTrack directly on screen and in real time.

Adding Emergency Contacts

Emergency contact phone numbers are used for the safety and tracking features.

- 1 From the Garmin Connect app, select ●●●.
- 2 Select **Safety & Tracking > Safety Features > Emergency Contacts > Add Emergency Contacts**.
- 3 Follow the on-screen instructions.

Your emergency contacts receive a notification when you add them as an emergency contact, and can accept or decline your request. If a contact declines, you must choose another emergency contact.

Adding Contacts

You can add up to 50 contacts to the Garmin Connect app. Contact emails can be used with the LiveTrack feature. Three of these contacts can be used as emergency contacts ([Adding Emergency Contacts, page 140](#)).

- 1 From the Garmin Connect app, select ●●●.
- 2 Select **Contacts**.
- 3 Follow the on-screen instructions.

After you add contacts, you must sync your data to apply the changes to your Descent device ([Using the Garmin Connect App, page 135](#)).

Turning Incident Detection On and Off

CAUTION

Incident detection is a supplemental feature available only for certain outdoor activities. Incident detection should not be relied on as a primary method to obtain emergency assistance. The Garmin Connect app does not contact emergency services on your behalf.

NOTICE

Before you can enable incident detection on your watch, you must set up emergency contacts in the Garmin Connect app ([Adding Emergency Contacts, page 140](#)). Your paired phone must be equipped with a data plan and be in an area of network coverage where data is available. Your emergency contacts must be able to receive emails or text messages (standard text messaging rates may apply).

- 1 From the watch face, hold **MENU**.
- 2 Select **Safety & Tracking > Incident Detection**.
- 3 Select a GPS activity.

NOTE: Incident detection is available only for certain outdoor activities.

When an incident is detected by your Descent watch and your phone is connected, the Garmin Connect app can send an automated text message and email with your name and GPS location (if available) to your emergency contacts. A message appears on your device and paired phone indicating your contacts will be informed after 15 seconds have elapsed. If assistance is not needed, you can cancel the automated emergency message.

Requesting Assistance

CAUTION

Assistance is a supplemental feature and should not be relied upon as a primary method to obtain emergency assistance. The Garmin Connect app does not contact emergency services on your behalf.

NOTICE

Before you can request assistance, you must set up emergency contacts in the Garmin Connect app ([Adding Emergency Contacts, page 140](#)). Your paired phone must be equipped with a data plan and be in an area of network coverage where data is available. Your emergency contacts must be able to receive emails or text messages (standard text messaging rates may apply).

- 1 Hold **LIGHT**.
- 2 When you feel three vibrations, release the button to activate the assistance feature.
The countdown screen appears.
TIP: You can select **Cancel** before the countdown is complete to cancel the message.

Starting a GroupTrack Session

NOTICE

Your paired phone must be equipped with a data plan and be in an area of network coverage where data is available.

Before you can start a GroupTrack session, you must pair the watch with a compatible phone ([Pairing Your Phone, page 131](#)).

These instructions are for starting a GroupTrack session with a Descent watch. If your connections have other compatible devices, you can see them on the map. The other devices may not be able to display GroupTrack riders on the map.

- 1 On the Descent watch, hold **MENU**, and select **Safety & Tracking > GroupTrack > Show on Map** to enable viewing connections on the map screen.
- 2 In the Garmin Connect app, select **••• > Safety & Tracking > LiveTrack > ⋮ > Settings > GroupTrack**.
- 3 Select **All Connections** or **Invite Only** and select your connections.
- 4 Select **Start LiveTrack**.
- 5 On the watch, start an outdoor activity.
- 6 Scroll to the map to view your connections.

TIP: From the map, you can hold **MENU** and select **Nearby Connections** to view distance, direction, and pace or speed information for other connections in the GroupTrack session.

Tips for GroupTrack Sessions

The GroupTrack feature allows you to keep track of other connections in your group using LiveTrack directly on the screen. All members of the group must be your connections in your Garmin Connect account.

- Start your activity outside using GPS.
- Pair your Descent device with your phone using Bluetooth technology.
- In the Garmin Connect app, select **••• > Connections** to update the list of connections for your GroupTrack session.
- Make sure all of your connections pair with their phones and start a LiveTrack session in the Garmin Connect app.
- Make sure all your connections are in range (40 km or 25 mi.).
- During a GroupTrack session, scroll to the map to view your connections ([Adding a Map to an Activity, page 60](#)).

GroupTrack Settings

Hold **MENU**, and select **Safety & Tracking > GroupTrack**.

Show on Map: Enables you to view connections on the map screen during a GroupTrack session.

Activity Types: Allows you to select which activity types appear on the map screen during a GroupTrack session.

Health and Wellness Settings

Hold **MENU**, and select **Health & Wellness**.

Heart Rate: Allows you to customize the wrist heart rate monitor settings (*Wrist Heart Rate Monitor Settings*, page 113).

Pulse Ox Mode: Allows you to select a pulse oximeter mode (*Setting the Pulse Oximeter Mode*, page 115).

Move Alert: Enables or disables the Move Alert feature (*Using the Move Alert*, page 143).

Goal Alerts: Allows you to turn on and off goal alerts, or turn them off only during activities. Goal alerts appear for your daily steps goal, daily floors climbed goal, and weekly intensity minutes goal.

Move IQ: Allows you to turn on and off Move IQ® events. When your movements match familiar exercise patterns, the Move IQ feature automatically detects the event and displays it in your timeline. The Move IQ events show activity type and duration, but they do not appear in your activities list or newsfeed. For more detail and accuracy, you can record a timed activity on your device.

Auto Goal

Your device creates a daily step goal automatically, based on your previous activity levels. As you move during the day, the device shows your progress toward your daily goal.

If you choose not to use the auto goal feature, you can set a personalized step goal on your Garmin Connect account.

Using the Move Alert

Sitting for prolonged periods of time can trigger undesirable metabolic state changes. The move alert reminds you to keep moving. After one hour of inactivity, Move! and the move bar appear. Additional segments appear after every 15 minutes of inactivity. The device also beeps or vibrates if audible tones are turned on (*System Settings*, page 152).

Go for a short walk (at least a couple of minutes) to reset the move alert.

Intensity Minutes

To improve your health, organizations such as the World Health Organization recommend at least 150 minutes per week of moderate intensity activity, such as brisk walking, or 75 minutes per week of vigorous intensity activity, such as running.

The watch monitors your activity intensity and tracks your time spent participating in moderate to vigorous intensity activities (heart rate data is required to quantify vigorous intensity). The watch adds the amount of moderate activity minutes with the amount of vigorous activity minutes. Your total vigorous intensity minutes are doubled when added.

Earning Intensity Minutes

Your Descent watch calculates intensity minutes by comparing your heart rate data to your average resting heart rate. If heart rate is turned off, the watch calculates moderate intensity minutes by analyzing your steps per minute.

- Start a timed activity for the most accurate calculation of intensity minutes.
- Wear your watch all day and night for the most accurate resting heart rate.

Sleep Tracking

While you are sleeping, the watch automatically detects your sleep and monitors your movement during your normal sleep hours. You can set your normal sleep hours in the Garmin Connect app or in the watch settings (*Customizing Sleep Mode*, page 154). Sleep statistics include total hours of sleep, sleep stages, sleep movement, and sleep score. Naps are added to your sleep statistics, and can also impact your recovery. You can view detailed sleep statistics on your Garmin Connect account.

NOTE: You can use do not disturb mode to turn off notifications and alerts, with the exception of alarms (*Controls*, page 106).

Using Automated Sleep Tracking

- 1 Wear your watch while sleeping.
- 2 Upload your sleep tracking data to the Garmin Connect site ([Using the Garmin Connect App, page 135](#)).
You can view your sleep statistics on your Garmin Connect account.
You can view sleep information from the previous night on your Descent watch ([Glances, page 86](#)).

Navigation

Viewing and Editing Your Saved Locations

TIP: You can save a location from the controls menu ([Controls, page 106](#)).

- 1 From the watch face, press **START**.
- 2 Select **Navigate > Saved Locations**.
- 3 Select a saved location.
- 4 Select an option to view or edit the location details.

Saving a Dual Grid Location

You can save your current location using dual grid coordinates to navigate back to the same location later.

- 1 Customize a button or button combination for the **Dual Grid** feature ([Customizing the Hot Keys, page 154](#)).
- 2 Hold the button or button combination you customized to save a dual grid location.
- 3 Wait while the watch locates satellites.
- 4 Press **START** to save the location.
- 5 If necessary, press **DOWN** to edit the location details.

Setting a Reference Point

You can set a reference point to provide the heading and distance to a location or bearing.

- 1 Select an option:
 - Hold **LIGHT**.
TIP: You can set a reference point while you are recording an activity.
 - From the watch face, press **START**.
- 2 Select **Reference Point**.
- 3 Wait while the watch locates satellites.
- 4 Press **START**, and select **Add Point**.
- 5 Select a location or bearing to use as a reference point for navigation.
The compass arrow and distance to your destination appear.
- 6 Point the top of the watch toward your heading.
When you deviate from the heading, the compass displays the direction from the heading and degree of deviation.
- 7 If necessary, press **START**, and select **Change Point** to set a different reference point.

Navigating to a Destination

You can use your device to navigate to a destination or follow a course.

- 1 From the watch face, press **START**.
- 2 Select an activity.
- 3 Hold **MENU**.
- 4 Select **Navigation**.
- 5 Select a category.
- 6 Respond to the on-screen prompts to choose a destination.
- 7 Select **Go To**.
Navigation information appears.
- 8 Press **START** to begin navigation.

Navigating to a Point of Interest

If the map data installed on your watch includes points of interest, you can navigate to them.

- 1 From the watch face, press **START**.
- 2 Select an activity.
- 3 Hold **MENU**.
- 4 Select **Navigation > Points of Interest**, and select a category.
A list of points of interest near your current location appears.
- 5 If necessary, select an option:
 - To search near a different location, select **Search Near**, and select a location.
 - To search for a point of interest by name, select **Spell Search**, and enter a name.
 - To search for nearby points of interest, select **Around Me** ([Navigating with the Around Me Feature, page 126](#)).
- 6 Select a point of interest from the search results.
- 7 Select **Go**.
Navigation information appears.
- 8 Press **START** to begin navigation.

Navigating to the Starting Point of a Saved Activity

You can navigate back to the starting point of a saved activity in a straight line or along the path you traveled. This feature is available only for activities that use GPS.

- 1 From the watch face, press **START**.
- 2 Select an activity.
- 3 Hold **MENU**.
- 4 Select **Navigation > Activities**.
- 5 Select an activity.
- 6 Select **Back to Start**, and select an option:
 - To navigate back to the starting point of your activity along the path you traveled, select **TracBack**.
 - If you do not have a supported map or are using direct routing, select **Route** to navigate back to the starting point of your activity in a straight line.
 - If you are not using direct routing, select **Route** to navigate back to the starting point of your activity using turn-by-turn directions.

Turn-by-turn directions help you navigate to the starting point of your last saved activity if you have a supported map or are using direct routing. A line appears on the map from your current location to the starting point of the last saved activity if you are not using direct routing.

NOTE: You can start the timer to prevent the device from timing out to watch mode.

- 7 Press **DOWN** to view the compass (optional).
The arrow points toward your starting point.

Navigating to Your Starting Point During an Activity

You can navigate back to the starting point of your current activity in a straight line or along the path you traveled. This feature is available only for activities that use GPS.

- 1 During an activity, press **STOP**.
- 2 Select **Back to Start**, and select an option:
 - To navigate back to the starting point of your activity along the path you traveled, select **TracBack**.
 - If you do not have a supported map or are using direct routing, select **Route** to navigate back to the starting point of your activity in a straight line.
 - If you are not using direct routing, select **Route** to navigate back to the starting point of your activity using turn-by-turn directions.

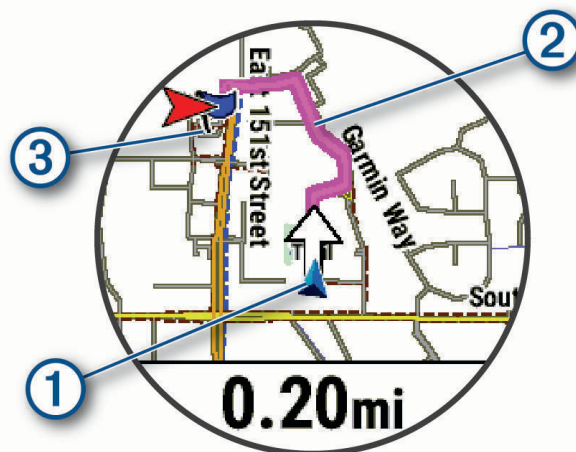

Your current location ①, the track to follow ②, and your destination ③ appear on the map.

Viewing Route Directions

You can view a list of turn-by-turn directions for your route.

- 1 While navigating a route, hold **MENU**.
- 2 Select **Turn By Turn**.
A list of turn-by-turn directions appears.
- 3 Press **DOWN** to view additional directions.

Navigating with Sight 'N Go

You can point the device at an object in the distance, such as a water tower, lock in the direction, and then navigate to the object.

- 1 From the watch face, press **START**.
- 2 Select an activity.
- 3 Hold **MENU**.
- 4 Select **Navigation > Sight 'N Go**.
- 5 Point the top of the watch at an object, and press **START**.
Navigation information appears.
- 6 Press **START** to begin navigation.

Marking and Starting Navigation to a Man Overboard Location

You can save a man overboard (MOB) location, and automatically start navigation back to it.

TIP: You can customize the hold function of the keys to access the MOB function (*Customizing the Hot Keys*, page 154).

- 1 From the watch face, press **START**.
- 2 Select an activity.
- 3 Hold **MENU**.
- 4 Select **Navigation > Last MOB**.
Navigation information appears.

Stopping Navigation

- 1 During an activity, hold **MENU**.
- 2 Select **Stop Navigation**.

Courses

WARNING

This feature allows users to download routes created by other users. Garmin makes no representations about the safety, accuracy, reliability, completeness, or timeliness of routes created by third parties. Any use or reliance on routes created by third parties is at your own risk.

You can send a course from your Garmin Connect account to your device. After it is saved to your device, you can navigate the course on your device.

You can follow a saved course simply because it is a good route. For example, you can save and follow a bike friendly commute to work.

You can also follow a saved course, trying to match or exceed previously set performance goals. For example, if the original course was completed in 30 minutes, you can race against a Virtual Partner trying to complete the course in under 30 minutes.

Creating and Following a Course on Your Device

- 1 From the watch face, press **START**.
- 2 Select an activity.
- 3 Hold **MENU**.
- 4 Select **Navigation > Courses > Create New**.
- 5 Enter a name for the course, and select **✓**.
- 6 Select **Add Location**.
- 7 Select an option.
- 8 If necessary, repeat steps 6 and 7.
- 9 Select **Done > Do Course**.
Navigation information appears.
- 10 Press **START** to begin navigation.

Creating a Round-Trip Course

The device can create a round-trip course based on a specified distance and direction of navigation.

- 1 From the watch face, press **START**.
- 2 Select **Run** or **Bike**.
- 3 Hold **MENU**.
- 4 Select **Navigation > Round-Trip Course**.
- 5 Enter the total distance for the course.
- 6 Select a direction heading.
The device creates up to three courses. You can press **DOWN** to view the courses.
- 7 Press **START** to select a course.
- 8 Select an option:
 - To begin navigation, select **Go**.
 - To view the course on the map and pan or zoom the map, select **Map**.
 - To view a list of turns in the course, select **Turn By Turn**.
 - To view an elevation plot of the course, select **Elevation Plot**.
 - To save the course, select **Save**.
 - To view a list of ascents in the course, select **View Climbs**.

Creating a Course on Garmin Connect

Before you can create a course on the Garmin Connect app, you must have a Garmin Connect account ([Garmin Connect, page 134](#)).

- 1 From the Garmin Connect app, select **•••**.
- 2 Select **Training & Planning > Courses > Create Course**.
- 3 Select a course type.
- 4 Follow the on-screen instructions.
- 5 Select **Done**.

NOTE: You can send this course to your device ([Sending a Course to Your Device, page 149](#)).

Sending a Course to Your Device

You can send a course you created using the Garmin Connect app to your device ([Creating a Course on Garmin Connect, page 148](#)).

- 1 From the Garmin Connect app, select **•••**.
- 2 Select **Training & Planning > Courses**.
- 3 Select a course.
- 4 Select .
- 5 Select your compatible device.
- 6 Follow the on-screen instructions.

Viewing or Editing Course Details

You can view or edit course details before you navigate a course.

- 1 From the watch face, press **START**.
- 2 Select an activity.
- 3 Hold **MENU**.
- 4 Select **Navigate > Courses**.
- 5 Select a course.
- 6 Select an option:
 - To begin navigation, select **Do Course**.
 - To create a custom pace band, select **PacePro**.
 - To create or view an analysis of your effort for the course, select **Power Guide**.
 - To view the course on the map and pan or zoom the map, select **Map**.
 - To begin the course in reverse, select **Do Course in Reverse**.
 - To view an elevation plot of the course, select **Elevation Plot**.
 - To change the course name, select **Name**.
 - To edit the course path, select **Edit**.
 - To view a list of ascents in the course, select **View Climbs**.
 - To delete the course, select **Delete**.

Projecting a Waypoint

You can create a new location by projecting the distance and bearing from your current location to a new location.

NOTE: You may need to add the Project Wpt. app to the activities and apps list.

- 1 From the watch face, press **START**.
- 2 Select **Project Wpt.**
- 3 Press **UP** or **DOWN** to set the heading.
- 4 Press **START**.
- 5 Press **DOWN** to select a unit of measure.
- 6 Press **UP** to enter the distance.
- 7 Press **START** to save.

The projected waypoint is saved with a default name.

Navigation Settings

You can customize the map features and appearance when navigating to a destination.

Customizing Navigation Data Screens

- 1 Hold **MENU**.
- 2 Select **Navigation > Data Screens**.
- 3 Select an option:
 - Select **Map > Status** to turn on or off the map.
 - Select **Map > Data Field** to turn on or off a data field that shows routing information on the map.
 - Select **Up Ahead** to turn on or off information about upcoming course points.
 - Select **Guide** to turn on or off the guide screen that displays the compass bearing or course to follow while navigating.
 - Select **Elevation Plot** to turn on or off the elevation plot.
 - Select a screen to add, remove, or customize.

Setting Up a Heading Bug

You can set up a heading indicator to display on your data pages while navigating. The indicator points to your target heading.

- 1 Hold **MENU**.
- 2 Select **Navigation > Heading Bug**.

Setting Navigation Alerts

You can set alerts to help you navigate to your destination.

- 1 Hold **MENU**.
- 2 Select **Navigation > Alerts**.
- 3 Select an option:
 - To set an alert for a specified distance from your final destination, select **Final Distance**.
 - To set an alert for the estimated time remaining until you reach your final destination, select **Final ETE**.
 - To set an alert when you stray from the course, select **Off Course**.
 - To enable turn-by-turn navigation prompts, select **Turn Prompts**.
- 4 If necessary, select **Status** to turn on the alert.
- 5 If necessary, enter a distance or time value, and select .

Power Manager Settings

Hold **MENU**, and select **Power Manager**.

Battery Saver: Allows you to customize system settings to extend battery life in watch mode (*Customizing the Battery Saver Feature, page 151*).

Power Modes: Allows you to customize system settings, activity settings, and GPS settings to extend battery life during an activity (*Customizing Power Modes, page 151*).

Battery Percentage: Displays remaining battery life as a percentage.

Battery Estimates: Displays remaining battery life as an estimated number of days or hours.

Customizing the Battery Saver Feature

The battery saver feature allows you to quickly adjust system settings to extend battery life in watch mode. You can turn on the battery saver feature from the controls menu ([Controls, page 106](#)).

- 1 Hold **MENU**.
- 2 Select **Power Manager > Battery Saver**.
- 3 Select **Status** to turn on the battery saver feature.
- 4 Select **Edit**, and select an option:
 - Select **Watch Face** to enable a low-power watch face that updates once per minute.
 - Select **Music** to disable listening to music from your watch.
 - Select **Phone** to disconnect your paired phone.
 - Select **Wi-Fi** to disconnect from a Wi-Fi network.
 - Select **Wrist Heart Rate** to turn off the wrist heart rate monitor.
 - Select **Pulse Oximeter** to turn off the pulse oximeter sensor.
 - Select **Always On Display** to turn off the screen when not in use.
 - Select **Brightness** to reduce the screen brightness.

The watch displays the hours of battery life gained with each setting change.
- 5 Select **Low Battery Alert** to receive an alert when the battery power is low.

Changing the Power Mode

You can change the power mode to extend battery life during an activity.

- 1 During an activity, hold **MENU**.
- 2 Select **Power Mode**.
- 3 Select an option.

The watch displays the hours of battery life available with the selected power mode.

Customizing Power Modes

Your device comes preloaded with several power modes, allowing you to quickly adjust system settings, activity settings, and GPS settings to extend battery life during an activity. You can customize existing power modes and create new custom power modes.

- 1 Hold **MENU**.
- 2 Select **Power Manager > Power Modes**.
- 3 Select an option:
 - Select a power mode to customize.
 - Select **Add New** to create a custom power mode.
- 4 If necessary, enter a custom name.
- 5 Select an option to customize specific power mode settings.

For example, you can change the GPS setting or disconnect your paired phone.

The watch displays the hours of battery life gained with each setting change.
- 6 If necessary, select **Done** to save and use the custom power mode.

Restoring a Power Mode

You can reset a preloaded power mode to the factory default settings.

- 1 Hold **MENU**.
- 2 Select **Power Manager > Power Modes**.
- 3 Select a preloaded power mode.
- 4 Select **Restore > Yes**.

System Settings

Hold **MENU**, and select **System**.

Language: Sets the language displayed on the watch.

Time: Adjusts the time settings ([Time Settings, page 152](#)).

Display: Adjusts the screen settings ([Changing the Screen Settings, page 153](#)).

Touch: Allows you to enable or disable the touchscreen during general use, activities, or sleep.

Satellites: Sets the default satellite system to use for activities. If necessary, you can customize the satellite setting for each activity ([Satellite Settings, page 66](#)).

Sound and Vibe: Sets the watch sounds, such as button tones, alerts, and vibrations.

Sleep Mode: Allows you to set your sleep hours and sleep mode preferences ([Customizing Sleep Mode, page 154](#)).

Night Vision: Allows you to enable or disable the touchscreen and set your display preferences for night vision mode.

Do Not Disturb: Allows you to enable the Do Not Disturb mode. You can edit your preferences for the screen, notifications, alerts, and wrist gestures.

Hot Keys: Allows you to assign shortcuts to buttons ([Customizing the Hot Keys, page 154](#)).

Auto Lock: Allows you to lock the buttons and touchscreen automatically to prevent accidental button presses and touchscreen swipes. Use the During Activity option to lock the buttons and touchscreen during a timed activity. Use the Not During Activity option to lock the buttons and touchscreen when you are not recording a timed activity.

Format: Sets general format preferences, such as the units of measure, pace and speed shown during activities, the start of the week, and geographical position format and datum options ([Changing the Units of Measure, page 154](#)).

Perf. Condition: Enables the performance condition feature during an activity ([Performance Condition, page 95](#)).

Data Recording: Sets how the watch records activity data. The Smart recording option (default) allows for longer activity recordings. The Every Second recording option provides more detailed activity recordings, but may not record entire activities that last for longer periods of time.

USB Mode: Sets the watch to use MTP (media transfer protocol) or Garmin mode when connected to a computer.

Back Up & Restore: Allows you to enable automatic backups of watch data and settings and back up your data now. You can restore data from a previous backup using the Garmin Connect app.

Reset: Allows you to reset user data and settings ([Resetting All Default Settings, page 161](#)).

Software Update: Allows you to install downloaded software updates, enable automatic updates, or manually check for updates ([Product Updates, page 159](#)). You can select What's New to view a list of new features from the last software update you installed.

About: Displays device, software, license, and regulatory information.

Time Settings

Hold **MENU**, and select **System > Time**.

Time Format: Sets the watch to show time in a 12-hour, 24-hour, or military format.

Date Format: Sets the display order for the day, month, and year for dates.

Set Time: Sets the time zone for the watch. The Auto option sets the time zone automatically based on your GPS position.

Time: Allows you to adjust the time if the Set Time option is set to Manual.

Alerts: Allows you to set hourly alerts, as well as sunrise and sunset alerts that sound a specific number of minutes or hours before the actual sunrise or sunset occurs ([Setting Time Alerts, page 153](#)).

Time Sync: Allows you to manually sync the time when you change time zones, and to update for daylight saving time ([Syncing the Time, page 153](#)).

Setting Time Alerts

- 1 Hold **MENU**.
- 2 Select **System > Time > Alerts**.
- 3 Select an option:
 - To set an alert to sound a specific number of minutes or hours before the actual sunset occurs, select **Til Sunset > Status > On**, select **Time**, and enter the time.
 - To set an alert to sound a specific number of minutes or hours before the actual sunrise occurs, select **Til Sunrise > Status > On**, select **Time**, and enter the time.
 - To set an alert to sound every hour, select **Hourly > On**.

Syncing the Time

Each time you turn on the device and acquire satellites or open the Garmin Connect app on your paired phone, the device automatically detects your time zones and the current time of day. You can also manually sync the time when you change time zones, and to update for daylight saving time.

- 1 Hold **MENU**.
 - 2 Select **System > Time > Time Sync**.
 - 3 Wait while the device connects to your paired phone or locates satellites ([Acquiring Satellite Signals, page 162](#)).
- TIP:** You can press **DOWN** to switch the source.

Changing the Screen Settings

- 1 Hold **MENU**.
- 2 Select **System > Display**.
- 3 Select **Night Vision** to adjust the screen for compatibility with night vision goggles (optional).
- 4 Select an option:
 - Select **In-Dive**.
 - Select **During Activity**.
 - Select **General Use**.
 - Select **During Sleep**.
- 5 Select an option:
 - Select **Always On Display** to keep the watch face data visible and turn down the brightness and background. This option impacts the battery and display life.
 - Select **Mode** to turn on the screen at depth or throughout your dive.
 - Select **Brightness** to set the brightness level of the screen.
 - Select **Red Shift** to turn the screen to shades of red so that you can use the watch in low light conditions and help preserve your night vision.
 - Select **Alerts** to turn on the screen for alerts.
 - Select **Wrist Gesture** to turn on the screen by raising and turning your arm to look at your wrist.
 - Select **Timeout** to set the length of time before the screen turns off.

Customizing Sleep Mode

- 1 Hold **MENU**.
- 2 Select **System > Sleep Mode**.
- 3 Select an option:
 - Select **Schedule**, select a day, and enter your normal sleep hours.
 - Select **Watch Face** to use the sleep watch face.
 - Select **Display** to configure the screen settings.
 - Select **Nap Alarm** to set nap alarms to play as a tone, vibration, or both.
 - Select **Touch** to turn the touchscreen on or off.
 - Select **Do Not Disturb** to enable or disable do not disturb mode.
 - Select **Battery Saver** to enable or disable battery saver mode ([Customizing the Battery Saver Feature, page 151](#)).

Customizing the Hot Keys

You can customize the hold function of individual buttons and combinations of buttons.

- 1 Hold **MENU**.
- 2 Select **System > Hot Keys**.
- 3 Select a button or combination of buttons to customize.
- 4 Select a function.

Changing the Units of Measure

You can customize units of measure for distance, pace and speed, elevation, and more.

- 1 Hold **MENU**.
- 2 Select **System > Format > Units**.
- 3 Select a measurement type.
- 4 Select a unit of measure.

Viewing Device Information

You can view device information, such as the unit ID, software version, regulatory information, and license agreement.

- 1 Hold **MENU**.
- 2 Select **System > About**.

Viewing E-label Regulatory and Compliance Information

The label for this device is provided electronically. The e-label may provide regulatory information, such as identification numbers provided by the FCC or regional compliance markings, as well as applicable product and licensing information.

- 1 Hold **MENU**.
- 2 From the system menu, select **About**.

Device Information

About the AMOLED Display

By default, the watch settings are optimized for battery life and performance ([Tips for Maximizing the Battery Life](#), page 162).

Image persistence, or pixel "burn-in," is normal behavior for AMOLED devices. To extend the display life, you should avoid displaying static images at high brightness levels for long time periods. To minimize burn-in, the Descent display turns off after the selected timeout ([Changing the Screen Settings](#), page 153). You can turn your wrist toward your body, tap the touchscreen, or press a button to wake the watch.

Charging the Watch

⚠ WARNING

This device contains a lithium-ion battery. See the *Important Safety and Product Information* guide in the product box for product warnings and other important information.

NOTICE

To prevent corrosion, thoroughly clean and dry the contacts and the surrounding area before charging or connecting to a computer. Refer to the cleaning instructions ([Device Care](#), page 157).

- 1 Pinch the sides of the charging clip.
- 2 Align the clip with the contacts on the back of the watch, and release the clip.

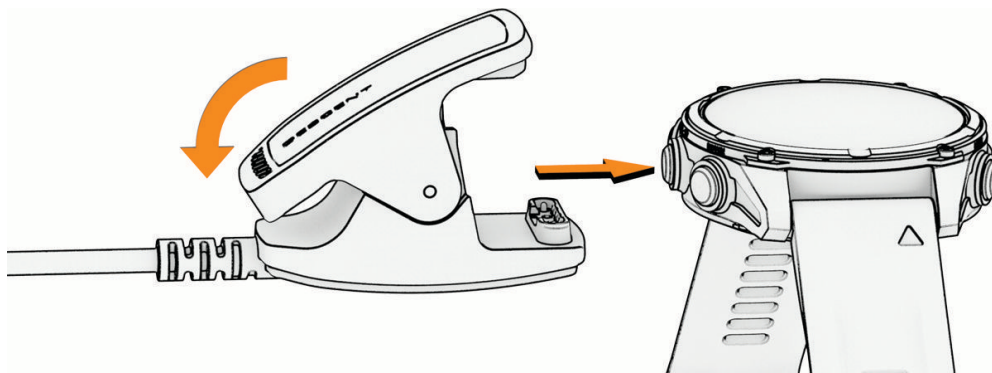

- 3 Plug the USB cable into a USB charging port.
The watch displays the current battery charge level.

Specifications

Battery type	Rechargeable, built-in lithium-ion battery
Water rating	20 ATM ¹
Operating and storage temperature range	From -20° to 45°C (from -4° to 113°F)
Underwater operating temperature range	From 0° to 40°C (from 32° to 104°F)
USB charging temperature range	From 0° to 45°C (from 32° to 113°F)
European Union (EU) wireless frequencies (power)	2.4 GHz @ 0 dBm maximum 13.56 MHz @ -30 dBm maximum
EU SAR values	0.11 W/kg limb, 0.11 W/kg torso
Depth sensor	Accurate from 0 m to 200 m (0 ft. to 656 ft.) complying with EN 13319 Resolution (m): 0.1 m until 99.9 m, 1 m at 100 m Resolution (ft.): 1 ft.
Inspection interval	Inspect parts before each use for damage. Replace parts as needed. ²

Battery Information

The actual battery life depends on the features enabled on your watch, such as wrist-based heart rate, phone notifications, GPS, internal sensors, and connected sensors.

¹ The device withstands pressure equivalent to a depth of 200 m. For more information, go to www.garmin.com/waterrating.

² Aside from normal wear and tear, performance is not affected by aging.

Mode	Descent Mk3/Mk3i - 43 mm Battery Life	Descent Mk3i - 51 mm Battery Life
Smartwatch mode	Up to 10 days with Wrist Gesture Up to 4 days with Always On Display	Up to 25 days with Wrist Gesture Up to 10 days with Always On Display
Battery saver watch mode	Up to 12 days with Wrist Gesture Not applicable for Always On Display	Up to 31 days with Wrist Gesture Not applicable for Always On Display
GPS only mode	Up to 28 hours with Wrist Gesture Up to 22 hours with Always On Display	Up to 76 hours with Wrist Gesture Up to 56 hours with Always On Display
All satellite systems mode	Up to 20 hours with Wrist Gesture Up to 16 hours with Always On Display	Up to 55 hours with Wrist Gesture Up to 43 hours with Always On Display
All satellite systems plus multi-band mode	Up to 17 hours with Wrist Gesture Up to 14 hours with Always On Display	Up to 48 hours with Wrist Gesture Up to 38 hours with Always On Display
All satellite systems with music mode	Up to 6 hours with Wrist Gesture Up to 6 hours with Always On Display	Up to 17 hours with Wrist Gesture Up to 17 hours with Always On Display
Max. battery GPS mode	Up to 44 hours with Wrist Gesture Not applicable for Always On Display	Up to 118 hours with Wrist Gesture Not applicable for Always On Display
Expedition GPS mode	Up to 10 days with Wrist Gesture Not applicable for Always On Display	Up to 24 days with Wrist Gesture Not applicable for Always On Display
Dive mode	Not applicable for Wrist Gesture Up to 30 hours with Always On Display	Not applicable for Wrist Gesture Up to 66 hours with Always On Display
Dive mode with air integration NOTE: This mode is only available for the Descent Mk3i models.	Not applicable for Wrist Gesture Up to 15 hours with Always On Display	Not applicable for Wrist Gesture Up to 40 hours with Always On Display

Device Care

NOTICE

Do not use a sharp object to clean the device.

Avoid chemical cleaners, solvents, and insect repellents that can damage plastic components and finishes.

Thoroughly rinse the device with fresh water after exposure to chlorine, salt water, sunscreen, cosmetics, alcohol, or other harsh chemicals. Prolonged exposure to these substances can damage the case.

Do not wash the device under high pressure, because jets of water or air may cause damage to the depth sensor or barometer.

Avoid extreme shock and harsh treatment, because it can degrade the life of the product.

Do not store the device where prolonged exposure to extreme temperatures can occur, because it can cause permanent damage.

Discontinue use if the device is damaged or if it is stored at a temperature outside the specified storage temperature range.

Cleaning the Watch

⚠ CAUTION

Some users may experience skin irritation after prolonged use of the watch, especially if the user has sensitive skin or allergies. If you notice any skin irritation, remove the watch and give your skin time to heal. To help prevent skin irritation, ensure the watch is clean and dry, and do not overtighten the watch on your wrist.

NOTICE

Even small amounts of sweat or moisture can cause corrosion of the electrical contacts when connected to a charger. Corrosion can prevent charging and data transfer.

TIP: For more information, go to garmin.com/fitandcare.

- 1 Rinse with water, or use a damp lint-free cloth.
- 2 Allow the watch to dry completely.

Changing the QuickFit® Bands

- 1 Slide the latch on the QuickFit band, and remove the band from the watch.

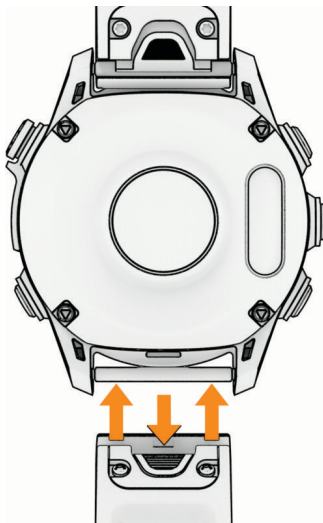

- 2 Align the new band with the watch.
- 3 Press the band into place.
NOTE: Make sure the band is secure. The latch should close over the watch pin.
- 4 Repeat steps 1 through 3 to change the other band.

Extra Long Diving Band

Your device comes with an extra long band you can wear over a thick exposure suit.

Metal Watch Band Adjustment

If your watch includes a metal watch band, you should take your watch to a jeweler or other professional to adjust the length of the metal band.

Data Management

NOTE: The device is not compatible with Windows 95, 98, Me, Windows NT®, and Mac® OS 10.3 and earlier.

Deleting Files

NOTICE

If you do not know the purpose of a file, do not delete it. Your device memory contains important system files that should not be deleted.

- 1 Open the **Garmin** drive or volume.
- 2 If necessary, open a folder or volume.
- 3 Select a file.
- 4 Press the **Delete** key on your keyboard.

NOTE: Mac operating systems provide limited support for MTP file transfer mode. You must open the Garmin drive on a Windows operating system. You should use the Garmin Express application to remove music files from your device.

Troubleshooting

Product Updates

Your device automatically checks for updates when connected to Bluetooth or Wi-Fi. You can manually check for updates from the system settings (*System Settings*, page 152). On your computer, install Garmin Express (www.garmin.com/express). On your phone, install the Garmin Connect app.

This provides easy access to these services for Garmin devices:

- Software updates
- Map updates
- Course updates
- Data uploads to Garmin Connect
- Product registration

Getting More Information

You can find more information about this product on the Garmin website.

- Go to support.garmin.com for additional manuals, articles, and software updates.
- Go to buy.garmin.com, or contact your Garmin dealer for information about optional accessories and replacement parts.
- Go to www.garmin.com/ataccuracy for information about feature accuracy.

This is not a medical device.

My device is in the wrong language

You can change the device language selection if you have accidentally selected the wrong language on the device.

- 1 Hold **MENU**.
- 2 Scroll down to the last item in the list, and press **START**.
- 3 Press **START**.
- 4 Select your language.

Is my phone compatible with my watch?

The Descent watch is compatible with phones using Bluetooth technology.

Go to garmin.com/ble for Bluetooth compatibility information.

My phone will not connect to the watch

If your phone will not connect to the watch, you can try these tips.

- Turn off your phone and your watch, and turn them back on again.
- Enable Bluetooth technology on your phone.
- Update the Garmin Dive app to the latest version.
- Remove your watch from the Garmin Dive app and the Bluetooth settings on your phone to retry the pairing process.
- If you bought a new phone, remove your watch from the Garmin Dive app on the phone you intend to stop using.
- Bring your phone within 10 m (33 ft.) of the watch.
- On your phone, open the Garmin Dive app, and select ●●● > **Garmin Devices** > **Add Device** to enter pairing mode.
- From the watch face, hold **MENU**, and select **Connectivity** > **Phone** > **Pair Phone**.

Can I use my Bluetooth sensor with my watch?

The watch is compatible with some Bluetooth sensors. The first time you connect a sensor to your Garmin watch, you must pair the watch and sensor. After they are paired, the watch connects to the sensor automatically when you start an activity and the sensor is active and within range.

- 1 Hold **MENU**.
- 2 Select **Sensors & Accessories** > **Add New**.
- 3 Select an option:
 - Select **Search All Sensors**.
 - Select your sensor type.

You can customize the optional data fields ([Customizing the Data Screens, page 60](#)).

My headphones will not connect to the watch

If your Bluetooth headphones were previously connected to your phone, they may connect to your phone automatically instead of connecting to your watch. You can try these tips.

- Turn off Bluetooth technology on your phone.
Refer to the owner's manual for your phone for more information.
- Stay 10 m (33 ft.) away from your phone while connecting your headphones to your watch.
- Pair your headphones with your watch ([Connecting Bluetooth Headphones, page 130](#)).

My music cuts out or my headphones won't stay connected

When using a Descent watch connected to Bluetooth headphones, the signal is strongest when there is a direct line of sight between the watch and the antenna on the headphones.

- If the signal passes through your body, you may experience signal loss or your headphones may become disconnected.
- If you wear your Descent watch on your left wrist, you should make sure the headphone's Bluetooth antenna is on your left ear.
- Since headphones vary by model, you can try wearing the watch on your other wrist.
- If you are using metal or leather watch bands, you can switch to silicone watch bands to improve signal strength.

Restarting Your Watch

- 1 Hold **LIGHT** until the watch turns off.
- 2 Hold **LIGHT** to turn on the watch.

Resetting All Default Settings

Before you reset all default settings, you should sync the watch with the Garmin Connect app to upload your activity data.

You can reset all of the watch settings to the factory default values.

1 Hold **MENU**.

2 Select **System > Reset**.

3 Select an option:

- To reset all of the watch settings to the factory default values and save all user-entered information and activity history, select **Reset Default Settings**.
- To delete all activities from the history, select **Delete All Activities**.
- To reset all distance and time totals, select **Reset Totals**.
- To delete all downloaded golf course files and reset the last played golf course list, select **Reset Golf Courses**.
- To reset all of the watch settings to the factory default values and delete all user-entered information and activity history, select **Delete Data and Reset Settings**.

NOTE: If you have set up a Garmin Pay wallet, this option deletes the wallet from your watch. If you have music stored on your watch, this option deletes your stored music.

Diving

Resetting Your Tissue Load

You can reset your current tissue load saved on the device. You should reset your tissue load only if you do not plan to use the device again in the future. This can be useful for dive shops that provide devices for rent.

1 Hold **MENU**.

2 Select **System > Reset > Reset Tissues**.

Resetting the Surface Pressure

The device automatically determines the surface pressure using the barometric altimeter. Large pressure changes, such as during a flight, can cause the watch to automatically start a dive activity. If the watch starts a dive activity incorrectly, you can reset the surface pressure by connecting the watch to a computer. If you do not have access to a computer, you can reset the surface pressure manually.

1 Hold **LIGHT** until the watch turns off.

2 Hold **LIGHT** to turn on the watch.

3 When the product logo appears, hold **MENU** until you are prompted to reset the surface pressure.

Tips for Maximizing the Battery Life

To extend the life of the battery, you can try these tips.

- Change the power mode during an activity (*Changing the Power Mode, page 151*).
 - Turn on the battery saver feature from the controls menu (*Controls, page 106*).
 - Reduce the screen timeout (*Changing the Screen Settings, page 153*).
 - Stop using the **Always On Display** screen timeout option, and select a shorter timeout (*Changing the Screen Settings, page 153*).
 - Reduce the screen brightness (*Changing the Screen Settings, page 153*).
 - Use UltraTrac satellite mode for your activity (*Satellite Settings, page 66*).
 - Turn off Bluetooth technology when you are not using connected features (*Controls, page 106*).
 - When pausing your activity for a longer period of time, use the **Resume Later** option (*Stopping an Activity, page 33*).
 - Use a watch face that is not updated every second.
For example, use a watch face without a second hand (*Customizing the Watch Face, page 85*).
 - Limit the phone notifications the watch displays (*Managing Notifications, page 132*).
 - Stop broadcasting heart rate data to paired devices (*Broadcasting Heart Rate Data, page 113*).
 - Turn off wrist-based heart rate monitoring (*Wrist Heart Rate Monitor Settings, page 113*).
- NOTE:** Wrist-based heart rate monitoring is used to calculate vigorous intensity minutes and calories burned.
- Turn on manual pulse oximeter readings (*Setting the Pulse Oximeter Mode, page 115*).

Acquiring Satellite Signals

The device may need a clear view of the sky to acquire satellite signals. The time and date are set automatically based on the GPS position.

TIP: For more information about GPS, go to garmin.com/aboutGPS.

- 1 Go outdoors to an open area.
The front of the device should be oriented toward the sky.
- 2 Wait while the device locates satellites.
It may take 30–60 seconds to locate satellite signals.

Improving GPS Satellite Reception

- Frequently sync the watch to your Garmin account:
 - Connect your watch to a computer using the USB cable and the Garmin Express application.
 - Sync your watch to the Garmin Dive app using your Bluetooth enabled phone.
 - Connect your watch to your Garmin account using a Wi-Fi wireless network.

While connected to your Garmin account, the watch downloads several days of satellite data, allowing it to quickly locate satellite signals.

- Take your watch outside to an open area away from tall buildings and trees.
- Remain stationary for a few minutes.

The activity temperature reading is not accurate

Your body temperature affects the temperature reading for the internal temperature sensor. To get the most accurate temperature reading, you should remove the watch from your wrist and wait 20 to 30 minutes.

You can also use an optional temperature external temperature sensor to view accurate ambient temperature readings while wearing the watch.

Activity Tracking

For more information about activity tracking accuracy, go to garmin.com/ataccuracy.

My step count does not seem accurate

If your step count does not seem accurate, you can try these tips.

- Wear the watch on your non-dominant wrist.
- Carry the watch in your pocket when pushing a stroller or lawn mower.
- Carry the watch in your pocket when actively using your hands or arms only.

NOTE: The watch may interpret some repetitive motions, such as washing dishes, folding laundry, or clapping your hands, as steps.

The step counts on my watch and my Garmin Connect account don't match

The step count on your Garmin Connect account updates when you sync your watch.

1 Select an option:

- Sync your step count with the Garmin Express application ([Using Garmin Connect on Your Computer, page 135](#)).
- Sync your step count with the Garmin Connect app ([Using the Garmin Connect App, page 135](#)).

2 Wait while your data syncs.

Syncing can take several minutes.

NOTE: Refreshing the Garmin Connect app or the Garmin Express application does not sync your data or update your step count.

The floors climbed amount does not seem accurate

Your watch uses an internal barometer to measure elevation changes as you climb floors. A floor climbed is equal to 3 m (10 ft.).

- Avoid holding handrails or skipping steps while climbing stairs.
- In windy environments, cover the watch with your sleeve or jacket as strong gusts can cause erratic readings.

Appendix

Data Fields

NOTE: Not all data fields are available for all activity types. Some data fields require ANT+ or Bluetooth accessories to display data. Some data fields appear in more than one category on the watch.

TIP: You can also customize the data fields from the watch settings in the Garmin Connect app.

Cadence Fields

Name	Description
Average Cadence	Cycling. The average cadence for the current activity.
Average Cadence	Running. The average cadence for the current activity.
Cadence	Cycling. The number of revolutions of the crank arm. Your device must be connected to a cadence accessory for this data to appear.
Cadence	Running. The steps per minute (right and left).
Lap Cadence	Cycling. The average cadence for the current lap.
Lap Cadence	Running. The average cadence for the current lap.
Last Lap Cadence	Cycling. The average cadence for the last completed lap.
Last Lap Cadence	Running. The average cadence for the last completed lap.

Charts

Name	Description
Barometer Chart	A chart showing the barometric pressure over time.
Elevation Chart	A chart showing the elevation over time.
Heart Rate Chart	A chart showing your heart rate throughout the activity.
Pace Chart	A chart showing your pace throughout the activity.
Power Chart	A chart showing your power throughout the activity.
Speed Chart	A chart showing your speed throughout the activity.

Compass Fields

Name	Description
Compass Heading	The direction you are moving based on the compass.
GPS Heading	The direction you are moving based on GPS.
Heading	The direction you are moving.

Distance Fields

Name	Description
Distance	The distance traveled for the current track or activity.
Interval Distance	The distance traveled for the current interval.
Lap Distance	The distance traveled for the current lap.
Last Lap Distance	The distance traveled for the last completed lap.

Diving Fields

Name	Description
Ascent Rate	The current rate of ascent toward the surface.
Avg Temperature	The average temperature during the activity.
CNS	Your current central nervous system oxygen toxicity percentage.
Current Gas PO2	The partial pressure of oxygen (PO2) of the diluent gas during a closed-circuit rebreather (CCR) dive.
Dive Number	The number of dives you have completed.
Last Dive Ascent Time	The amount of time you spent ascending to the surface during the last dive.
Last Dive Avg. Asc. Rate	The average rate of ascent during the last dive.
Last Dive Avg. Desc. Rate	The average rate of descent during the last dive.
Last Dive Avg Heart Rate	Your average heart rate during the last dive.
Last Dive Avg Temperature	The average temperature during the last dive.
Last Dive Beginning Heart Rate	Your heart rate at the beginning of the last dive.
Last Dive Depth	The maximum depth achieved during the last dive.
Last Dive Descent Time	The amount of time you spent descending to the maximum depth during the last dive.
Last Dive Ending Heart Rate	Your heart rate at the end of the last dive.
Last Dive Hang Time	The amount of time you spent neither ascending nor descending during the last dive.
Last Dive Max Asc. Rate	The maximum rate of ascent during the last dive.
Last Dive Max Desc. Rate	The maximum rate of descent during the last dive.
Last Dive Max Heart Rate	Your maximum heart rate during the last dive.
Last Dive Max Temperature	The maximum temperature during the last dive.
Last Dive Min Heart Rate	Your minimum heart rate during the last dive.
Last Dive Min Temperature	The minimum temperature during the last dive.
Last Dive Time	The amount of time you spent below the surface during the last dive.
Maximum Depth	The maximum depth descended during a dive.
Max Temperature	The maximum temperature during the activity.

Name	Description
Min Temperature	The minimum temperature during the activity.
N2/He Load	Your current nitrogen and helium tissue load level.
OTU	Your current oxygen toxicity units.
Surface Distance	The surface distance between the dive entry and exit points during the dive activity.
Surface Gradient Factor	The expected gradient factor if the diver were to instantaneously surface.
Surface Time	The amount of time elapsed since surfacing from a dive.
Time to Surface	The amount of time required to safely ascend to the surface.
Total Dive Time	The total amount of time spent below the surface during the dive activity.

Elevation Fields

Name	Description
Average Ascent	The average vertical distance of ascent since the last reset.
Average Descent	The average vertical distance of descent since the last reset.
Elevation	The altitude of your current location above or below sea level.
Glide Ratio	The ratio of horizontal distance traveled to the change in vertical distance.
GPS Elevation	The altitude of your current location using GPS.
Grade	The calculation of rise (elevation) over run (distance). For example, if for every 3 m (10 ft.) you climb you travel 60 m (200 ft.), the grade is 5%.
Lap Ascent	The vertical distance of ascent for the current lap.
Lap Descent	The vertical distance of descent for the current lap.
Last Lap Ascent	The vertical distance of ascent for the last completed lap.
Last Lap Descent	The vertical distance of descent for the last completed lap.
Maximum Ascent	The maximum rate of ascent in feet per minute or meters per minute since the last reset.
Maximum Descent	The maximum rate of descent in meters per minute or feet per minute since the last reset.
Maximum Elevation	The highest elevation reached since the last reset.
Minimum Elevation	The lowest elevation reached since the last reset.
Total Ascent	The total elevation distance ascended since the last reset.
Total Descent	The total elevation distance descended since the last reset.

Floors Fields

Name	Description
Floors Climbed	The total number of floors climbed up for the day.
Floors Descended	The total number of floors climbed down for the day.
Floors per Minute	The number of floors climbed up per minute.

Gears

Name	Description
Di2 Battery	The remaining battery power of a Di2 sensor.
eBike Battery	The remaining battery power of an ebike.
eBike Range	The estimated remaining distance the ebike can provide assistance.
Front	The front bike gear from a gear position sensor.
Gear Battery	The battery status of a gear position sensor.
Gear Combo	The current gear combination from a gear position sensor.
Gears	The front and rear bike gears from a gear position sensor.
Gear Ratio	The number of teeth on the front and rear bike gears, as detected by a gear position sensor.
Rear	The rear bike gear from a gear position sensor.

Graphical

Name	Description
Cadence Gauge	Running. A color gauge showing your current cadence range.
Compass Gauge	The direction you are moving based on the compass.
GCT Balance Gauge	A color gauge showing the left/right balance of ground contact time while running.
Ground Contact Time Gauge	A color gauge showing the amount of time in each step that you spend on the ground while running, measured in milliseconds.
Heart Rate Gauge	A color gauge showing your current heart rate zone.
Heart Rate Zones Ratio	A color gauge showing the ratio of time spent in each heart rate zone.
PacePro Gauge	Running. Your current split pace and your target split pace.
Power Gauge	A color gauge showing your current power zone.
Stamina Gauge (Dist.)	A gauge showing your current stamina distance remaining.
Stamina Gauge (Time)	A gauge showing your current stamina time remaining.
Total Ascent/Descent Gauge	The total elevation distances ascended and descended during the activity or since the last reset.
Training Effect Gauge	The impact of the current activity on your aerobic and anaerobic fitness levels.
Vertical Oscillation Gauge	A color gauge showing the amount of bounce while you are running.
Vertical Ratio Gauge	A color gauge showing the ratio of vertical oscillation to stride length.

Heart Rate Fields

Name	Description
% Heart Rate Reserve	The percentage of heart rate reserve (maximum heart rate minus resting heart rate).
Aerobic Training Effect	The impact of the current activity on your aerobic fitness level.
Anaerobic Training Effect	The impact of the current activity on your anaerobic fitness level.
Average % Heart Rate Reserve	The average percentage of heart rate reserve (maximum heart rate minus resting heart rate) for the current activity.
Average Heart Rate	The average heart rate for the current activity.
Average Heart Rate %Max.	The average percentage of maximum heart rate for the current activity.
Heart Rate	Your heart rate in beats per minute (bpm). Your device must have wrist-based heart rate or be connected to a compatible heart rate monitor.
Heart Rate %Max.	The percentage of maximum heart rate.
Heart Rate Zone	The current range of your heart rate (1 to 5). The default zones are based on your user profile and maximum heart rate (220 minus your age).
Interval Average %HRR	The average percentage of heart rate reserve (maximum heart rate minus resting heart rate) for the current swim interval.
Interval Average %Max.	The average percentage of maximum heart rate for the current swim interval.
Interval Average Heart Rate	The average heart rate for the current swim interval.
Interval Maximum %HRR	The maximum percentage of heart rate reserve (maximum heart rate minus resting heart rate) for the current swim interval.
Interval Maximum %Max.	The maximum percentage of maximum heart rate for the current swim interval.
Interval Maximum Heart Rate	The maximum heart rate for the current swim interval.
Lap % Heart Rate Reserve	The average percentage of heart rate reserve (maximum heart rate minus resting heart rate) for the current lap.
Lap Heart Rate	The average heart rate for the current lap.
Lap Heart Rate %Max.	The average percentage of maximum heart rate for the current lap.
Last Lap %HRR	The average percentage of heart rate reserve (maximum heart rate minus resting heart rate) for the last completed lap.
Last Lap Heart Rate	The average heart rate for the last completed lap.
Last Lap Heart Rate %Max.	The average percentage of maximum heart rate for the last completed lap.
Time in Zone	The time elapsed in each heart rate zone.

Lengths Fields

Name	Description
Interval Lengths	The number of pool lengths completed during the current interval.
Lengths	The number of pool lengths completed during the current activity.

Muscle Oxygen Fields

Name	Description
Muscle O2 Saturation %	The estimated muscle oxygen saturation percentage for the current activity.
Total Hemoglobin	The estimated total hemoglobin concentration in the muscle.

Navigation Fields

Name	Description
Bearing	The direction from your current location to a destination. You must be navigating for this data to appear.
Course	The direction from your starting location to a destination. Course can be viewed as a planned or set route. You must be navigating for this data to appear.
Destination Location	The position of your final destination.
Destination Waypoint	The last point on the route to the destination. You must be navigating for this data to appear.
Distance Remaining	The remaining distance to the final destination. You must be navigating for this data to appear.
Distance To Next	The remaining distance to the next waypoint on the route. You must be navigating for this data to appear.
Estimated Total Distance	The estimated distance from the start to the final destination. You must be navigating for this data to appear.
ETA	The estimated time of day when you will reach the final destination (adjusted to the local time of the destination). You must be navigating for this data to appear.
ETA at Next	The estimated time of day when you will reach the next waypoint on the route (adjusted to the local time of the waypoint). You must be navigating for this data to appear.
ETE	The estimated time remaining until you reach the final destination. You must be navigating for this data to appear.
Glide Ratio to Destination	The glide ratio required to descend from your current position to the destination elevation. You must be navigating for this data to appear.
Lat/Lon	The current position in latitude and longitude regardless of the selected position format setting.
Location	The current position using the selected position format setting.
Next Fork	The distance to the next fork on a trail.
Next Waypoint	The next point on the route. You must be navigating for this data to appear.
Off Course	The distance to the left or right by which you have strayed from the original path of travel. You must be navigating for this data to appear.
Time to Next	The estimated time remaining before you reach the next waypoint in the route. You must be navigating for this data to appear.
Velocity Made Good	The speed at which you are closing on a destination along a route. You must be navigating for this data to appear.

Name	Description
Vertical Dist. to Dest.	The elevation distance between your current position and the final destination. You must be navigating for this data to appear.
Vertical Speed to Target	The rate of ascent or descent to a predetermined altitude. You must be navigating for this data to appear.

Other Fields

Name	Description
Active Calories	The calories burned during the activity.
Ambient Pressure	The uncalibrated environmental pressure.
Barometric Pressure	The current calibrated environmental pressure.
Battery Hours	The number of hours remaining before the battery power is depleted.
Battery Percentage	The percentage of the battery power remaining.
COG	The actual direction of travel, regardless of the course steered and temporary variations in heading.
Distance to Start Line	The remaining distance to the race starting line. You must be navigating for this data to appear.
Flow	The measurement of how consistently you maintain speed and smoothness through turns in the current activity.
GPS	The strength of the GPS satellite signal.
Grit	The measurement of difficulty for the current activity based on elevation, gradient, and rapid changes in direction.
Lap Flow	The overall flow score for the current lap.
Lap Grit	The overall grit score for the current lap.
Laps	The number of laps completed for the current activity.
Lift	The amount of lift time during a sailing activity.
Load	The training load for the current activity. Training load is the amount of excess post-exercise oxygen consumption (EPOC), which indicates the strenuousness of your workout.
Performance Condition	The performance condition score is a real-time assessment of your ability to perform.
Reps	During a strength training activity, the number of repetitions in a workout set.
Respiration Rate	Your respiration rate in breaths per minute (brpm).
Runs	The number of runs for the activity.
Steps	The number of steps taken during the current activity.
Stress	Your current stress level.
Sunrise	The time of sunrise based on your GPS position.
Sunset	The time of sunset based on your GPS position.

Name	Description
Tack Assist	A gauge to help you determine if your boat is being lifted or headed.
Time of Day	The time of day based on your current location and time settings (format, time zone, daylight saving time).
Time of Day (Seconds)	The time of day including seconds.
Total Calories	The amount of total calories burned for the day.

Pace Fields

Name	Description
500m Pace	The current rowing pace per 500 meters.
Average 500m Pace	The average rowing pace per 500 meters for the current activity.
Average Pace	The average pace for the current activity.
Grade Adjusted Pace	The average pace adjusted by the steepness of the terrain.
Interval Pace	The average pace for the current interval.
Lap 500m Pace	The average rowing pace per 500 meters for the current lap.
Lap Pace	The average pace for the current lap.
Last Lap 500m Pace	The average rowing pace per 500 meters for the last lap.
Last Lap Pace	The average pace for the last completed lap.
Last Length Pace	The average pace for your last completed pool length.
Pace	The current pace.

PacePro Fields

Name	Description
Next Split Distance	Running. The total distance of the next split.
Next Split Target Pace	Running. The target pace for the next split.
Split Distance	Running. The total distance of the current split.
Split Distance Remaining	Running. The remaining distance of the current split.
Split Pace	Running. The pace for the current split.
Split Target Pace	Running. The target pace for the current split.

Power Fields

Name	Description
% Functional Threshold Power	The current power output as a percentage of functional threshold power.
3s Balance	The 3-second moving average of the left/right power balance.
3s Power	The 3-second moving average of power output.
10s Balance	The 10-second moving average of the left/right power balance.
10s Power	The 10-second moving average of power output.
30s Balance	The 30-second moving average of the left/right power balance.
30s Power	The 30-second moving average of power output.
Average Balance	The average left/right power balance for the current activity.
Average Left Power Phase	The average power phase angle for the left leg for the current activity.
Average Power	The average power output for the current activity.
Average Right Power Phase	The average power phase angle for the right leg for the current activity.
Avg. Left Peak Power Phase	The average power phase peak angle for the left leg for the current activity.
Avg. Platform Center Offset	The average platform center offset for the current activity.
Avg. Right Peak Power Phase	The average power phase peak angle for the right leg for the current activity.
Balance	The current left/right power balance.
Intensity Factor	The Intensity Factor™ for the current activity.
Lap Balance	The average left/right power balance for the current lap.
Lap Left Peak Power Phase	The average power phase peak angle for the left leg for the current lap.
Lap Left Power Phase	The average power phase angle for the left leg for the current lap.
Lap Normalized Power	The average Normalized Power™ for the current lap.
Lap Platform Center Offset	The average platform center offset for the current lap.
Lap Power	The average power output for the current lap.
Lap Right Peak Power Phase	The average power phase peak angle for the right leg for the current lap.
Lap Right Power Phase	The average power phase angle for the right leg for the current lap.
Last Lap Max. Power	The top power output for the last completed lap.
Last Lap Normalized Power	The average Normalized Power for the last completed lap.
Last Lap Power	The average power output for the last completed lap.
Left Peak Power Phase	The current power phase peak angle for the left leg. Power phase peak is the angle range over which the rider produces the peak portion of the driving force.
Left Power Phase	The current power phase angle for the left leg. Power phase is the pedal stroke region where positive power is produced.

Name	Description
Maximum Lap Power	The top power output for the current lap.
Maximum Power	The top power output for the current activity.
Normalized Power	The Normalized Power for the current activity.
Pedal Smoothness	The measurement of how evenly a rider is applying force to the pedals throughout each pedal stroke.
Platform Center Offset	The platform center offset. Platform center offset is the location on the pedal platform where force is applied.
Power	The current power output in watts. For skiing activities, your device must be connected to a compatible heart rate monitor.
Power to Weight	The current power measured in watts per kilogram.
Power Zone	The current range of power output based on your FTP or custom settings.
Right Peak Power Phase	The current power phase peak angle for the right leg. Power phase peak is the angle range over which the rider produces the peak portion of the driving force.
Right Power Phase	The current power phase angle for the right leg. Power phase is the pedal stroke region where positive power is produced.
Time in Zone	The time elapsed in each power zone.
Time Seated	The time spent seated while pedaling for the current activity.
Time Seated Lap	The time spent seated while pedaling for the current lap.
Time Standing	The time spent standing while pedaling for the current activity.
Time Standing Lap	The time spent standing while pedaling for the current lap.
Training Stress Score	The Training Stress Score™ for the current activity.
Torque Efficiency	The measurement of how efficiently a rider is pedaling.
Work	The accumulated work performed (power output) in kilojoules.

Rest Fields

Name	Description
Repeat On	The timer for the last interval plus the current rest (pool swimming).
Rest Timer	The timer for the current rest (pool swimming).

Run Dynamics

Name	Description
Average GCT Balance	The average ground contact time balance for the current session.
Average Ground Contact Time	The average amount of ground contact time for the current activity.
Average Stride Length	The average stride length for the current session.
Average Vertical Oscillation	The average amount of vertical oscillation for the current activity.
Average Vertical Ratio	The average ratio of vertical oscillation to stride length for the current session.
GCT Balance	The left/right balance of ground contact time while running.
Ground Contact Time	The amount of time in each step that you spend on the ground while running, measured in milliseconds. Ground contact time is not calculated while walking.
Lap GCT Balance	The average ground contact time balance for the current lap.
Lap Ground Contact Time	The average amount of ground contact time for the current lap.
Lap Stride Length	The average stride length for the current lap.
Lap Vertical Oscillation	The average amount of vertical oscillation for the current lap.
Lap Vertical Ratio	The average ratio of vertical oscillation to stride length for the current lap.
Stride Length	The length of your stride from one footfall to the next, measured in meters.
Vertical Oscillation	The amount of bounce while you are running. The vertical motion of your torso, measured in centimeters for each step.
Vertical Ratio	The ratio of vertical oscillation to stride length.

Speed Fields

Name	Description
Average Moving Speed	The average speed when moving for the current activity.
Average Overall Speed	The average speed for the current activity, including both moving and stopped speeds.
Average Speed	The average speed for the current activity.
Avg. SOG	The average speed of travel for the current activity, regardless of the course steered and temporary variations in heading.
Lap SOG	The average speed of travel for the current lap, regardless of the course steered and temporary variations in heading.
Lap Speed	The average speed for the current lap.
Last Lap SOG	The average speed of travel for the last completed lap, regardless of the course steered and temporary variations in heading.
Last Lap Speed	The average speed for the last completed lap.
Maximum SOG	The maximum speed of travel for the current activity, regardless of the course steered and temporary variations in heading.
Maximum Speed	The top speed for the current activity.
Speed	The current rate of travel.
Speed Over Ground	The actual speed of travel, regardless of the course steered and temporary variations in heading.
Vertical Speed	The rate of ascent or descent over time.

Stamina Fields

Name	Description
Stamina	The current remaining stamina.
Distance Remaining	The current stamina distance remaining at the current effort.
Stamina Potential	The remaining potential stamina.
Time Remaining	The current stamina time remaining at the current effort.

Stroke Fields

Name	Description
Average Distance Per Stroke	Swimming. The average distance traveled per stroke during the current activity.
Average Distance Per Stroke	Paddle sports. The average distance traveled per stroke during the current activity.
Average Stroke Rate	Paddle sports. The average number of strokes per minute (spm) during the current activity.
Average Strokes Per Length	The average number of strokes per pool length during the current activity.
Distance Per Stroke	Paddle sports. The distance traveled per stroke.
Interval Stroke Rate	The average number of strokes per minute (spm) during the current interval.
Interval Strokes Per Length	The average number of strokes per pool length during the current interval.
Interval Stroke Type	The current stroke type for the interval.
Lap Distance Per Stroke	Swimming. The average distance traveled per stroke during the current lap.
Lap Distance Per Stroke	Paddle sports. The average distance traveled per stroke during the current lap.
Lap Stroke Rate	Swimming. The average number of strokes per minute (spm) during the current lap.
Lap Stroke Rate	Paddle sports. The average number of strokes per minute (spm) during the current lap.
Lap Strokes	Swimming. The total number of strokes for the current lap.
Lap Strokes	Paddle sports. The total number of strokes for the current lap.
Last Lap Distance Per Stroke	Swimming. The average distance traveled per stroke during the last completed lap.
Last Lap Distance Per Stroke	Paddle sports. The average distance traveled per stroke during the last completed lap.
Last Lap Stroke Rate	Swimming. The average number of strokes per minute (spm) during the last completed lap.
Last Lap Stroke Rate	Paddle sports. The average number of strokes per minute (spm) during the last completed lap.
Last Lap Strokes	Swimming. The total number of strokes for the last completed lap.
Last Lap Strokes	Paddle sports. The total number of strokes for the last completed lap.
Last Length Stroke Rate	The average number strokes per minute (spm) during the last completed pool length.
Last Length Strokes	The total number of strokes for the last completed pool length.
Last Length Stroke Type	The stroke type used during the last completed pool length.
Stroke Rate	Swimming. The number of strokes per minute (spm).
Stroke Rate	Paddle sports. The number of strokes per minute (spm).
Strokes	Swimming. The total number of strokes for the current activity.

Name	Description
Strokes	Paddle sports. The total number of strokes for the current activity.

Swolf Fields

Name	Description
Average Swolf	The average swolf score for the current activity. Your swolf score is the sum of the time for one length plus the number of strokes for that length (Swim Terminology, page 35). In open water swimming, 25 meters is used to calculate your swolf score.
Interval Swolf	The average swolf score for the current interval.
Lap Swolf	The swolf score for the current lap.
Last Lap Swolf	The swolf score for the last completed lap.
Last Length Swolf	The swolf score for the last completed pool length.

Temperature Fields

Name	Description
24-Hour Maximum	The maximum temperature recorded in the last 24 hours from a compatible temperature sensor.
24-Hour Minimum	The minimum temperature recorded in the last 24 hours from a compatible temperature sensor.
Temperature	The temperature of the air. Your body temperature affects the temperature sensor. You can pair a temperature sensor with your device to provide a consistent source of accurate temperature data.

Timer Fields

Name	Description
Average Lap Time	The average lap time for the current activity.
Elapsed Time	The total time recorded. For example, if you start the activity timer and run for 10 minutes, then stop the timer for 5 minutes, then start the timer and run for 20 minutes, your elapsed time is 35 minutes.
Interval Time	The stopwatch time for the current interval.
Lap Time	The stopwatch time for the current lap.
Last Lap Time	The stopwatch time for the last completed lap.
Moving Time	The total time moving for the current activity.
Multisport Time	The total time for all sports in a multisport activity, including transitions.
Overall Ahead/Behind	The overall time ahead or behind of the target pace or speed.
Race Timer	The time elapsed in the current sail race.
Set Timer	During a strength training activity, the amount of time spent in the current workout set.
Stopped Time	The total time stopped for the current activity.
Swim Time	The swimming time for the current activity, not including rest time.
Timer	The current time of the countdown timer.

Workout Fields





Name	Description
Repetition	The number of repetitions remaining for the workout.
Step Distance	The current distance traveled during the workout step.
Step Pace	The current pace during the workout step.
Step Speed	The current speed during the workout step.
Step Time	The time elapsed for the workout step.

Color Gauges and Running Dynamics Data

The running dynamics screens display a color gauge for the primary metric. You can display cadence, vertical oscillation, ground contact time, ground contact time balance, or vertical ratio as the primary metric. The color gauge shows you how your running dynamics data compare to those of other runners. The color zones are based on percentiles.





Garmin has researched many runners of all different levels. The data values in the red or orange zones are typical for less experienced or slower runners. The data values in the green, blue, or purple zones are typical for more experienced or faster runners. More experienced runners tend to exhibit shorter ground contact times, lower vertical oscillation, lower vertical ratio, and higher cadence than less experienced runners. However, taller runners typically have slightly slower cadences, longer strides, and slightly higher vertical oscillation. Vertical ratio is your vertical oscillation divided by stride length. It is not correlated with height.

Go to garmin.com/runningdynamics for more information on running dynamics. For additional theories and interpretations of running dynamics data, you can search reputable running publications and websites.

Color Zone	Percentile in Zone	Cadence Range	Ground Contact Time Range
 Purple	>95	>183 spm	<218 ms
 Blue	70–95	174–183 spm	218–248 ms
 Green	30–69	164–173 spm	249–277 ms
 Orange	5–29	153–163 spm	278–308 ms
 Red	<5	<153 spm	>308 ms

Ground Contact Time Balance Data

Ground contact time balance measures your running symmetry and appears as a percentage of your total ground contact time. For example, 51.3% with an arrow pointing left indicates the runner is spending more time on the ground when on the left foot. If your data screen displays both numbers, for example 48–52, 48% is the left foot and 52% is the right foot.





Color Zone	 Red	 Orange	 Green	 Orange	 Red
Symmetry	Poor	Fair	Good	Fair	Poor
Percent of Other Runners	5%	25%	40%	25%	5%
Ground Contact Time Balance	>52.2% L	50.8–52.2% L	50.7% L–50.7% R	50.8–52.2% R	>52.2% R

While developing and testing running dynamics, the Garmin team found correlations between injuries and greater imbalances with certain runners. For many runners, ground contact time balance tends to deviate further from 50–50 when running up or down hills. Most running coaches agree that a symmetrical running form is good. Elite runners tend to have quick and balanced strides.

You can watch the gauge or data field during your run or view the summary on your Garmin Connect account after your run. As with the other running dynamics data, ground contact time balance is a quantitative measurement to help you learn about your running form.

Vertical Oscillation and Vertical Ratio Data

The data ranges for vertical oscillation and vertical ratio are slightly different depending on the sensor and whether it is positioned at the chest (HRM-Pro series, HRM-Run™, or HRM-Tri accessories) or at the waist (Running Dynamics Pod accessory).

Color Zone	Percentile in Zone	Vertical Oscillation Range at Chest	Vertical Oscillation Range at Waist	Vertical Ratio at Chest	Vertical Ratio at Waist
 Purple	>95	<6.4 cm	<6.8 cm	<6.1%	<6.5%
 Blue	70–95	6.4–8.1 cm	6.8–8.9 cm	6.1–7.4%	6.5–8.3%
 Green	30–69	8.2–9.7 cm	9.0–10.9 cm	7.5–8.6%	8.4–10.0%
 Orange	5–29	9.8–11.5 cm	11.0–13.0 cm	8.7–10.1%	10.1–11.9%
 Red	<5	>11.5 cm	>13.0 cm	>10.1%	>11.9%

VO2 Max. Standard Ratings

These tables include standardized classifications for VO2 max. estimates by age and sex.

Males	Percentile	20–29	30–39	40–49	50–59	60–69	70–79
Superior	95	55.4	54	52.5	48.9	45.7	42.1
Excellent	80	51.1	48.3	46.4	43.4	39.5	36.7
Good	60	45.4	44	42.4	39.2	35.5	32.3
Fair	40	41.7	40.5	38.5	35.6	32.3	29.4
Poor	0–40	<41.7	<40.5	<38.5	<35.6	<32.3	<29.4

Females	Percentile	20–29	30–39	40–49	50–59	60–69	70–79
Superior	95	49.6	47.4	45.3	41.1	37.8	36.7
Excellent	80	43.9	42.4	39.7	36.7	33	30.9
Good	60	39.5	37.8	36.3	33	30	28.1
Fair	40	36.1	34.4	33	30.1	27.5	25.9
Poor	0–40	<36.1	<34.4	<33	<30.1	<27.5	<25.9

Data reprinted with permission from The Cooper Institute. For more information, go to www.CooperInstitute.org.

FTP Ratings

These tables include classifications for functional threshold power (FTP) estimates by sex.

Males	Watts per Kilogram (W/kg)
Superior	5.05 and greater
Excellent	From 3.93 to 5.04
Good	From 2.79 to 3.92
Fair	From 2.23 to 2.78
Untrained	Less than 2.23

Females	Watts per Kilogram (W/kg)
Superior	4.30 and greater
Excellent	From 3.33 to 4.29
Good	From 2.36 to 3.32
Fair	From 1.90 to 2.35
Untrained	Less than 1.90

FTP ratings are based on research by Hunter Allen and Andrew Coggan, PhD, *Training and Racing with a Power Meter* (Boulder, CO: VeloPress, 2010).

Endurance Score Ratings

These tables include classifications for endurance score estimates by age and sex.

Males	Recreational	Intermediate	Trained	Well Trained	Expert	Superior	Elite
18-20	Less than 4999	5000-5699	5700-6299	6300-6999	7000-7599	7600-8299	8300 and greater
21-39	Less than 5099	5100-5799	5800-6599	6600-7299	7300-8099	8100-8799	8800 and greater
40-44	Less than 5099	5100-5799	5800-6499	6500-7199	7200-7899	7900-8599	8600 and greater
45-49	Less than 4999	5000-5699	5700-6399	6400-6999	7000-7699	7700-8399	8400 and greater
50-54	Less than 4899	4900-5499	5500-6099	6100-6799	6800-7399	7400-7999	8000 and greater
55-59	Less than 4599	4600-5099	5100-5699	5700-6199	6200-6799	6800-7299	7300 and greater
60-64	Less than 4299	4300-4799	4800-5299	5300-5699	5700-6199	6200-6699	6700 and greater
65-69	Less than 4099	4100-4499	4500-4899	4900-5399	5400-5799	5800-6199	6200 and greater
70-74	Less than 3799	3800-4199	4200-4599	4600-4899	4900-5299	5300-5699	5700 and greater
75-80	Less than 3599	3600-3899	3900-4299	4300-4599	4600-4999	5000-5299	5300 and greater
80 and older	Less than 3299	3300-3599	3600-3999	4000-4299	4300-4699	4700-4999	5000 and greater

Females	Recreational	Intermediate	Trained	Well Trained	Expert	Superior	Elite
18-20	Less than 4599	4600-5099	5100-5499	5500-5999	6000-6399	6400-6899	6900 and greater
21-39	Less than 4699	4700-5199	5200-5699	5700-6299	6300-6799	6800-7299	7300 and greater
40-44	Less than 4699	4700-5199	5200-5699	5700-6199	6200-6699	6700-7199	7200 and greater
45-49	Less than 4599	4600-5099	5100-5599	5600-6099	6100-6599	6600-7099	7100 and greater
50-54	Less than 4499	4500-4999	5000-5399	5400-5899	5900-6299	6300-6799	6800 and greater
55-59	Less than 4299	4300-4699	4700-5099	5100-5599	5600-5099	6000-6399	6400 and greater
60-64	Less than 4099	4100-4499	4500-4899	4900-5299	5300-5699	5700-6099	6100 and greater
65-69	Less than 3799	3800-4199	4200-4599	4600-4899	4900-5299	5300-5699	5700 and greater
70-74	Less than 3699	3700-4099	4100-4399	4400-4799	4800-5099	5100-5499	5500 and greater
75-80	Less than 3499	3500-3799	3800-4199	4200-4499	4500-4899	4900-5199	5200 and greater
80 and older	Less than 3199	3200-3499	3500-3799	3800-4099	4100-4399	4400-4699	4700 and greater

These estimates are provided and supported by Firstbeat Analytics.

Wheel Size and Circumference

Your speed sensor automatically detects your wheel size. If necessary, you can manually enter your wheel circumference in the speed sensor settings.

The tire size is marked on both sides of the tire. You can measure the circumference of your wheel or use one of the calculators available on the internet.

Symbol Definitions

These symbols may appear on the device or accessory labels.



WEEE disposal and recycling symbol. The WEEE symbol is attached to the product in compliance with the EU directive 2012/19/EU on Waste Electrical and Electronic Equipment (WEEE). It is intended to deter the improper disposal of this product and to promote reuse and recycling.

